



The Sizewell C Project

8.5 Consolidated Transport Assessment Appendices Part 5 of 6

Revision: 3.0
Applicable Regulation: Regulation 5(2)(q)
PINS Reference Number: EN010012

June 2021

Planning Act 2008
Infrastructure Planning (Applications: Prescribed
Forms and Procedure) Regulations 2009



CONSOLIDATED TRANSPORT ASSESSMENT APPENDICES

- Appendix 2A: PIC
- Appendix 2B: Bus Services and Stops
- Appendix 2C: Journey Times Variability
- Appendix 6A: 2015 Modelled Time Periods
- Appendix 7A: Sizewell C Gravity Model
- Appendix 7B: Sizewell C Traffic Calculations
- Appendix 7C: Shift Patterns
- Appendix 7D: Other additional Information
- Appendix 8A
 - Appendix 8A.1: Local Model Valuation Report
 - Appendix 8A.1: Local Model Valuation Report Addendum
 - Appendix 8A.2: Model LMVR Sensitivity
 - Appendix 8A.3: Model LMVR Addendum
- Appendix 8B:
 - Appendix 8B.1: 2023 Reference Case Inputs
 - Appendix 8B.2: 2028 Reference Case Inputs
 - Appendix 8B.3: 2034 Reference Case Inputs
- Appendix 8C
 - Appendix 8C.1: Sizewell Cumulative Traffic Inputs (EA1N and EA2)
 - Appendix 8C.2: SZC EXQ1 Response Paper
- Appendix 8D: SZC Traffic Flow Plots
- **Appendix 8E: Journey Times Tables and Graphs**
- **Appendix 8F: Sensitivity Test All HGVs from A12 South**
- **Appendix 9A: Junction Model Results Summary**
- **Appendix 9B: Yoxford VISSIM Model**
- Appendix 9C: A12 VISSIM Technical Note V.13 and Appendices
- Appendix 10A: RSA Designers Response
- Appendix 10B: Road Traffic Collisions

APPENDIX 8E

Journey Times Tables and Graphs

Modelled Journey Times Tables

Table 8E.1 – 2023 Early Years – Journey Times 06:00-07:00 hours

Route	Direction	Average Journey Time (mm:ss).		Difference from Reference Case.			
		2015 Base Year.	2023 Reference Case.	Seconds	%	Seconds	%
				Early Years.		Early Years (Cumulative).	
1	EB	18:27	18:37	2	0%	2	0%
	WB	18:35	18:52	0	0%	0	0%
2	NB	27:25	27:45	9	1%	9	1%
	SB	27:36	28:07	3	0%	3	0%
3	NB	25:31	25:31	0	0%	0	0%
	SB	25:36	25:40	3	0%	3	0%
4	EB	38:40	38:43	-5	0%	-5	0%
	WB	38:24	38:24	-12	-1%	-12	-1%
5	EB	37:15	37:15	-2	0%	-2	0%
	WB	36:42	36:43	4	0%	4	0%
6	NB	22:38	22:39	0	0%	0	0%
	SB	22:00	22:03	0	0%	0	0%
7	NB	26:49	26:50	1	0%	1	0%
	SB	27:26	27:28	1	0%	1	0%
8	NB	30:36	30:49	-1	0%	-1	0%
	SB	30:19	30:34	2	0%	2	0%
9	EB	26:44	26:44	1	0%	1	0%
	WB	26:49	26:49	0	0%	0	0%
10	NB	30:11	30:13	0	0%	0	0%
	SB	30:17	30:22	1	0%	1	0%
11	NB	04:08	04:07	0	0%	0	0%
	SB	03:40	03:39	1	0%	1	0%
12	NB	08:36	08:37	0	0%	0	0%
	SB	07:50	07:52	0	0%	0	0%
A1	NB	03:09	03:12	1	1%	1	1%
	SB	03:13	03:20	0	0%	0	0%
A2	NB	49:33	49:43	7	0%	7	0%
	SB	48:31	48:49	6	0%	6	0%
A3	NB	29:13	29:28	6	0%	6	0%
	SB	29:05	29:17	-2	0%	-2	0%
A4	NB	12:06	12:07	-8	-1%	-8	-1%
	SB	11:55	11:58	-5	-1%	-5	-1%
A5	NB	08:59	09:04	3	1%	3	1%
	SB	08:52	09:01	1	0%	1	0%

Table 8E.2 – 2023 Early Years – Journey Times 07:00-08:00 hours

Route	Direction	Average Journey Time (mm:ss).		Difference from Reference Case.			
		2015 Base Year.	2023 Reference Case.	Seconds	%	Seconds	%
				Early Years.		Early Years (Cumulative).	
1	EB	19:59	20:49	16	1%	19	2%
	WB	20:10	21:13	2	0%	4	0%
2	NB	29:14	30:25	90	5%	105	6%
	SB	29:55	32:36	44	2%	60	3%
3	NB	25:45	25:54	5	0%	5	0%
	SB	26:06	26:04	26	2%	26	2%
4	EB	38:53	38:59	6	0%	6	0%
	WB	38:44	38:50	-9	0%	-9	0%
5	EB	37:23	37:30	0	0%	0	0%
	WB	37:01	37:08	9	0%	9	0%
6	NB	22:55	23:02	0	0%	0	0%
	SB	22:18	22:20	3	0%	4	0%
7	NB	27:06	27:05	2	0%	3	0%
	SB	27:43	27:42	11	1%	11	1%
8	NB	31:25	31:52	25	1%	32	2%
	SB	31:37	33:35	35	2%	46	2%
9	EB	26:52	26:54	2	0%	2	0%
	WB	27:06	27:14	1	0%	3	0%
10	NB	31:07	31:17	4	0%	4	0%
	SB	31:32	31:49	1	0%	2	0%
11	NB	04:31	04:37	14	5%	17	6%
	SB	04:22	05:49	34	10%	45	13%
12	NB	08:45	08:47	0	0%	0	0%
	SB	07:57	07:59	0	0%	0	0%
A1	NB	03:17	03:25	5	2%	7	3%
	SB	03:22	03:41	1	0%	1	0%
A2	NB	57:36	59:40	74	2%	73	2%
	SB	50:24	52:08	70	2%	84	3%
A3	NB	30:03	30:34	77	4%	87	5%
	SB	30:26	32:14	40	2%	54	3%
A4	NB	12:09	12:10	-6	-1%	-6	-1%
	SB	12:01	12:01	4	1%	4	1%
A5	NB	09:38	09:57	30	5%	37	6%
	SB	09:57	11:48	35	5%	47	7%

Table 8E.3 – 2023 Early Years – Journey Times 08:00-09:00 hours

Route	Direction	Average Journey Time (mm:ss).		Difference from Reference Case.			
		2015 Base Year.	2023 Reference Case.	Seconds	%	Seconds	%
				Early Years.		Early Years (Cumulative).	
1	EB	21:06	22:21	5	0%	4	0%
	WB	20:35	21:37	3	0%	3	0%
2	NB	30:23	32:01	59	3%	124	6%
	SB	32:58	36:34	34	2%	63	3%
3	NB	25:55	25:56	4	0%	3	0%
	SB	26:08	26:13	4	0%	13	1%
4	EB	39:00	39:05	-4	0%	-1	0%
	WB	38:57	39:04	-10	0%	-9	0%
5	EB	37:35	37:43	-3	0%	-2	0%
	WB	37:17	37:26	7	0%	7	0%
6	NB	23:07	23:13	0	0%	0	0%
	SB	22:20	22:27	0	0%	1	0%
7	NB	27:31	27:21	1	0%	1	0%
	SB	27:44	27:47	4	0%	9	1%
8	NB	31:48	32:30	22	1%	77	4%
	SB	34:18	37:07	24	1%	51	2%
9	EB	26:57	27:05	1	0%	4	0%
	WB	27:22	28:07	4	0%	13	1%
10	NB	31:26	31:42	2	0%	2	0%
	SB	32:07	32:38	5	0%	7	0%
11	NB	04:40	04:48	7	2%	7	2%
	SB	06:48	07:43	8	2%	11	2%
12	NB	08:50	08:52	-1	0%	0	0%
	SB	08:34	08:47	1	0%	0	0%
A1	NB	03:21	03:38	11	5%	17	8%
	SB	03:27	05:11	15	5%	38	12%
A2	NB	59:47	01:01:34	46	1%	90	2%
	SB	53:06	54:31	20	1%	35	1%
A3	NB	30:25	30:57	43	2%	105	6%
	SB	33:08	34:30	12	1%	19	1%
A4	NB	12:11	12:11	-8	-1%	-7	-1%
	SB	12:01	12:01	-4	-1%	-1	0%
A5	NB	09:55	10:27	30	5%	83	13%
	SB	12:37	15:21	25	3%	51	6%

Table 8E.4 – 2023 Early Years – Journey Times 15:00-16:00 hours

Route	Direction	Average Journey Time (mm:ss).		Difference from Reference Case.			
		2015 Base Year.	2023 Reference Case.	Seconds	%	Seconds	%
				Early Years.		Early Years (Cumulative).	
1	EB	20:14	21:10	6	0%	1	0%
	WB	19:49	20:58	0	0%	3	0%
2	NB	31:10	33:59	42	2%	57	3%
	SB	29:56	33:57	63	3%	75	4%
3	NB	26:14	26:15	1	0%	2	0%
	SB	25:59	26:01	3	0%	3	0%
4	EB	38:55	39:00	-7	0%	-7	0%
	WB	38:36	38:47	-8	0%	-7	0%
5	EB	37:33	37:39	-2	0%	-2	0%
	WB	36:58	37:08	6	0%	6	0%
6	NB	23:13	23:28	0	0%	0	0%
	SB	22:17	22:21	0	0%	0	0%
7	NB	27:15	27:17	0	0%	2	0%
	SB	27:55	27:53	0	0%	1	0%
8	NB	33:05	35:18	29	1%	41	2%
	SB	31:33	34:43	53	3%	60	3%
9	EB	26:52	27:00	1	0%	2	0%
	WB	26:56	27:02	0	0%	1	0%
10	NB	30:50	31:03	0	0%	-1	0%
	SB	31:00	31:17	1	0%	2	0%
11	NB	05:48	06:47	-6	-1%	0	0%
	SB	04:18	05:04	46	15%	50	16%
12	NB	08:49	08:49	0	0%	0	0%
	SB	07:58	08:01	1	0%	1	0%
A1	NB	03:23	03:38	2	1%	2	1%
	SB	03:24	05:36	6	2%	7	2%
A2	NB	54:17	56:56	37	1%	52	2%
	SB	50:21	51:38	59	2%	69	2%
A3	NB	31:46	33:53	36	2%	51	3%
	SB	30:29	31:41	54	3%	64	3%
A4	NB	12:08	12:11	-7	-1%	-6	-1%
	SB	12:00	12:00	-7	-1%	-7	-1%
A5	NB	11:09	13:11	35	4%	48	6%
	SB	09:58	12:58	52	7%	58	7%

Table 8E.5– 2023 Early Years – Journey Times 16:00-17:00 hours

Route	Direction	Average Journey Time (mm:ss).		Difference from Reference Case.			
		2015 Base Year.	2023 Reference Case.	Seconds	%	Seconds	%
				Early Years.		Early Years (Cumulative).	
1	EB	20:58	22:03	5	0%	5	0%
	WB	21:05	22:35	5	0%	5	0%
2	NB	32:32	34:57	43	2%	58	3%
	SB	31:35	36:30	57	3%	79	4%
3	NB	26:31	26:36	3	0%	5	0%
	SB	25:57	25:58	1	0%	1	0%
4	EB	39:03	39:12	-6	0%	-6	0%
	WB	38:43	38:56	-7	0%	-6	0%
5	EB	37:43	37:52	-8	0%	-8	0%
	WB	37:03	37:15	13	1%	13	1%
6	NB	23:22	23:35	-1	0%	-1	0%
	SB	22:13	22:16	0	0%	0	0%
7	NB	27:11	27:15	4	0%	4	0%
	SB	27:50	27:48	1	0%	1	0%
8	NB	33:40	35:32	24	1%	34	2%
	SB	32:24	36:14	36	2%	50	2%
9	EB	27:04	27:22	5	0%	5	0%
	WB	27:16	27:49	8	0%	7	0%
10	NB	31:04	31:12	0	0%	-2	0%
	SB	31:49	32:22	4	0%	4	0%
11	NB	06:28	06:32	18	5%	24	6%
	SB	04:57	05:55	22	6%	35	10%
12	NB	08:50	08:50	2	0%	2	0%
	SB	08:12	08:16	0	0%	0	0%
A1	NB	03:22	03:33	2	1%	3	1%
	SB	03:26	06:07	14	4%	14	4%
A2	NB	54:50	57:12	37	1%	46	1%
	SB	51:13	52:34	39	1%	59	2%
A3	NB	32:51	34:45	31	1%	46	2%
	SB	31:19	32:40	36	2%	57	3%
A4	NB	12:14	12:16	-6	-1%	-5	-1%
	SB	11:57	11:58	-6	-1%	-6	-1%
A5	NB	11:55	13:38	27	3%	38	5%
	SB	10:41	14:21	36	4%	51	6%

Table 8E.6– 2023 Early Years – Journey Times 17:00-18:00 hours

Route	Direction	Average Journey Time (mm:ss).		Difference from Reference Case.			
		2015 Base Year.	2023 Reference Case.	Seconds	%	Seconds	%
				Early Years.		Early Years (Cumulative).	
1	EB	20:59	21:48	3	0%	6	0%
	WB	20:36	22:03	10	1%	10	1%
2	NB	32:06	34:48	42	2%	76	4%
	SB	29:59	34:10	85	4%	134	7%
3	NB	26:22	26:14	34	2%	40	3%
	SB	25:51	25:53	4	0%	4	0%
4	EB	38:59	39:04	-5	0%	-5	0%
	WB	38:38	38:46	-1	0%	3	0%
5	EB	37:40	37:45	-7	0%	-6	0%
	WB	37:01	37:11	15	1%	16	1%
6	NB	23:12	23:21	3	0%	5	0%
	SB	22:14	22:16	0	0%	0	0%
7	NB	27:07	27:09	10	1%	13	1%
	SB	27:49	27:47	1	0%	1	0%
8	NB	33:37	35:53	27	1%	58	3%
	SB	31:25	34:32	45	2%	74	4%
9	EB	27:02	27:15	6	0%	7	0%
	WB	27:10	27:34	6	0%	11	1%
10	NB	30:54	31:01	-2	0%	-2	0%
	SB	31:19	31:35	5	0%	6	0%
11	NB	06:16	06:32	2	1%	19	5%
	SB	04:11	04:19	25	10%	46	18%
12	NB	08:50	08:50	0	0%	0	0%
	SB	08:10	08:12	1	0%	2	0%
A1	NB	03:26	04:15	0	0%	5	2%
	SB	03:24	06:09	15	4%	22	6%
A2	NB	54:08	56:31	32	1%	66	2%
	SB	49:58	50:34	64	2%	106	3%
A3	NB	32:09	33:45	39	2%	65	3%
	SB	30:09	30:43	62	3%	105	6%
A4	NB	12:12	12:12	-1	0%	2	0%
	SB	11:56	11:57	-6	-1%	-6	-1%
A5	NB	11:41	13:47	33	4%	60	7%
	SB	09:49	12:45	44	6%	73	10%

Table 8E.7– 2023 Early Years – Journey Times 18:00-19:00 hours

Route	Direction	Average Journey Time (mm:ss).		Difference from Reference Case.			
		2015 Base Year.	2023 Reference Case.	Seconds	%	Seconds	%
				Early Years.		Early Years (Cumulative).	
1	EB	19:18	19:43	0	0%	4	0%
	WB	19:02	19:26	8	1%	9	1%
2	NB	29:06	30:01	4	0%	21	1%
	SB	28:14	29:17	52	3%	62	4%
3	NB	25:50	25:55	6	0%	6	0%
	SB	25:41	25:41	3	0%	4	0%
4	EB	38:45	38:51	-7	0%	-6	0%
	WB	38:28	38:32	-2	0%	-1	0%
5	EB	37:21	37:31	-8	0%	-8	0%
	WB	36:48	36:56	12	1%	12	1%
6	NB	22:47	22:51	3	0%	3	0%
	SB	22:06	22:07	1	0%	1	0%
7	NB	26:57	26:57	4	0%	4	0%
	SB	27:36	27:38	-1	0%	-1	0%
8	NB	31:35	32:04	-2	0%	3	0%
	SB	30:45	31:23	17	1%	24	1%
9	EB	26:51	26:54	1	0%	1	0%
	WB	26:55	26:57	1	0%	2	0%
10	NB	30:26	30:31	0	0%	0	0%
	SB	30:38	30:46	0	0%	0	0%
11	NB	04:38	04:46	1	0%	3	1%
	SB	03:52	04:00	7	3%	9	4%
12	NB	08:42	08:43	1	0%	1	0%
	SB	07:55	07:56	1	0%	1	0%
A1	NB	03:18	03:27	-1	0%	2	1%
	SB	03:17	03:34	8	4%	12	6%
A2	NB	50:48	51:24	12	0%	21	1%
	SB	49:00	49:30	36	1%	42	1%
A3	NB	30:12	30:48	1	0%	11	1%
	SB	29:23	29:55	35	2%	41	2%
A4	NB	12:09	12:11	-1	0%	0	0%
	SB	11:53	11:57	-7	-1%	-6	-1%
A5	NB	09:51	10:12	1	0%	6	1%
	SB	09:11	09:40	20	3%	27	5%

Table 8E.8 – 2028 Peak Construction – Journey Times 06:00-07:00 hours

Route	Direction	Average Journey Time (mm:ss).		Difference from Reference Case.							
		2015 Base Year.	2028 Reference Case.	Sec-onds	%	Sec-onds	%	Sec-onds	%	Sec-onds	%
				Core.				Cumulative.			
				2028 Peak Construction (Typical Day).		2028 Peak Construction (Busiest Day).		2028 Peak Construction (Typical Day).		2028 Peak Construction (Busiest Day).	
1	EB	18:27	18:40	4	0%	5	0%	4	0%	5	0%
	WB	18:35	18:57	0	0%	0	0%	0	0%	0	0%
2	NB	27:25	27:52	4	0%	8	0%	4	0%	8	0%
	SB	27:36	28:39	-14	-1%	-13	-1%	-14	-1%	-13	-1%
3	NB	25:31	25:31	5	0%	5	0%	5	0%	5	0%
	SB	25:36	25:40	20	1%	20	1%	20	1%	20	1%
4	EB	38:40	38:43	-64	-3%	-64	-3%	-64	-3%	-64	-3%
	WB	38:24	38:25	-76	-3%	-76	-3%	-76	-3%	-76	-3%
5	EB	37:15	37:15	-5	0%	-5	0%	-5	0%	-5	0%
	WB	36:42	36:44	5	0%	5	0%	5	0%	5	0%
6	NB	22:38	22:39	1	0%	1	0%	1	0%	1	0%
	SB	22:00	22:03	3	0%	3	0%	3	0%	3	0%
7	NB	26:49	26:50	4	0%	4	0%	4	0%	4	0%
	SB	27:26	27:28	-2	0%	-1	0%	-2	0%	-1	0%
8	NB	30:36	30:55	11	1%	13	1%	11	1%	13	1%
	SB	30:19	30:45	4	0%	4	0%	4	0%	4	0%
9	EB	26:44	26:44	7	0%	7	0%	7	0%	7	0%
	WB	26:49	26:50	1	0%	1	0%	1	0%	1	0%
10	NB	30:11	30:14	0	0%	0	0%	0	0%	0	0%
	SB	30:17	30:25	0	0%	0	0%	0	0%	0	0%
11	NB	04:08	04:08	2	1%	3	1%	2	1%	3	1%
	SB	03:40	03:43	-1	0%	-1	0%	-1	0%	-1	0%
12	NB	08:36	08:37	0	0%	0	0%	0	0%	0	0%
	SB	07:50	07:52	0	0%	0	0%	0	0%	0	0%
A1	NB	03:09	03:16	0	0%	0	0%	0	0%	0	0%
	SB	03:13	03:25	0	0%	0	0%	0	0%	0	0%
A2	NB	49:33	49:39	7	0%	9	0%	7	0%	9	0%
	SB	48:31	48:52	8	0%	8	0%	8	0%	8	0%
A3	NB	29:13	29:28	-179	-10%	-177	-10%	-179	-10%	-177	-10%
	SB	29:05	29:21	-196	-11%	-196	-11%	-196	-11%	-196	-11%
A4	NB	12:06	12:07	-75	-10%	-75	-10%	-75	-10%	-75	-10%
	SB	11:55	11:58	-64	-9%	-64	-9%	-64	-9%	-64	-9%
A5	NB	08:59	09:08	9	2%	11	2%	9	2%	11	2%
	SB	08:52	09:11	1	0%	1	0%	1	0%	1	0%

Table 8E.9 – 2028 Peak Construction – Journey Times 07:00-08:00 hours

Route	Direction	Average Journey Time (mm:ss).		Difference from Reference Case.							
		2015 Base Year.	2028 Reference Case.	Sec-onds	%	Sec-onds	%	Sec-onds	%	Sec-onds	%
				Core.				Cumulative.			
				2028 Peak Construction (Typical Day).		2028 Peak Construction (Busiest Day).		2028 Peak Construction (Typical Day).		2028 Peak Construction (Busiest Day).	
1	EB	19:59	21:22	13	1%	21	2%	18	1%	23	2%
	WB	20:10	21:25	1	0%	2	0%	4	0%	5	0%
2	NB	29:14	31:03	42	2%	70	4%	58	3%	103	6%
	SB	29:55	33:58	14	1%	22	1%	35	2%	38	2%
3	NB	25:45	25:58	6	0%	8	1%	7	0%	8	1%
	SB	26:06	26:05	29	2%	31	2%	31	2%	32	2%
4	EB	38:53	39:01	-63	-3%	-57	-2%	-61	-3%	-57	-2%
	WB	38:44	38:52	-71	-3%	-70	-3%	-70	-3%	-70	-3%
5	EB	37:23	37:30	-3	0%	-3	0%	-3	0%	-3	0%
	WB	37:01	37:11	6	0%	6	0%	6	0%	6	0%
6	NB	22:55	23:04	0	0%	0	0%	0	0%	0	0%
	SB	22:18	22:23	4	0%	4	0%	4	0%	4	0%
7	NB	27:06	27:07	5	0%	5	0%	6	0%	6	0%
	SB	27:43	27:44	-1	0%	-1	0%	-1	0%	-1	0%
8	NB	31:25	32:10	40	2%	55	3%	47	2%	81	4%
	SB	31:37	34:26	29	1%	34	2%	43	2%	44	2%
9	EB	26:52	26:55	7	0%	7	0%	7	0%	7	0%
	WB	27:06	27:23	4	0%	4	0%	4	0%	4	0%
10	NB	31:07	31:28	0	0%	0	0%	0	0%	0	0%
	SB	31:32	32:05	1	0%	1	0%	1	0%	2	0%
11	NB	04:31	04:40	11	4%	13	5%	13	5%	13	5%
	SB	04:22	06:28	26	7%	30	8%	38	10%	39	10%
12	NB	08:45	08:46	0	0%	0	0%	0	0%	0	0%
	SB	07:57	07:59	0	0%	0	0%	1	0%	1	0%
A1	NB	03:17	03:33	6	3%	9	4%	9	4%	10	5%
	SB	03:22	03:49	0	0%	1	0%	2	1%	2	1%
A2	NB	57:36	53:43	-1	0%	10	0%	8	0%	46	1%
	SB	50:24	52:53	42	1%	49	2%	59	2%	62	2%
A3	NB	30:03	30:44	-159	-9%	-136	-7%	-149	-8%	-105	-6%
	SB	30:26	32:58	-173	-9%	-167	-8%	-157	-8%	-155	-8%
A4	NB	12:09	12:11	-72	-10%	-71	-10%	-71	-10%	-71	-10%
	SB	12:01	12:02	-63	-9%	-57	-8%	-61	-8%	-57	-8%
A5	NB	09:38	10:12	32	5%	48	8%	-132	-22%	75	12%
	SB	09:57	12:38	27	4%	32	4%	93	12%	43	6%

Table 8E.10 – 2028 Peak Construction – Journey Times 08:00-09:00 hours

Route	Direction	Average Journey Time (mm:ss).		Difference from Reference Case.							
		2015 Base Year.	2028 Reference Case.	Sec-onds	%	Sec-onds	%	Sec-onds	%	Sec-onds	%
				Core.				Cumulative.			
				2028 Peak Construction (Typical Day).		2028 Peak Construction (Busiest Day).		2028 Peak Construction (Typical Day).		2028 Peak Construction (Busiest Day).	
1	EB	21:06	22:50	1	0%	1	0%	2	0%	0	0%
	WB	20:35	21:58	-1	0%	14	1%	2	0%	10	1%
2	NB	30:23	33:16	58	3%	87	4%	112	6%	152	8%
	SB	32:58	38:51	7	0%	46	2%	28	1%	43	2%
3	NB	25:55	26:01	10	1%	10	1%	10	1%	10	1%
	SB	26:08	26:13	13	1%	15	1%	22	1%	24	2%
4	EB	39:00	39:06	-63	-3%	-59	-3%	-58	-2%	-55	-2%
	WB	38:57	39:11	-79	-3%	-76	-3%	-78	-3%	-76	-3%
5	EB	37:35	37:44	-5	0%	-5	0%	-4	0%	-3	0%
	WB	37:17	37:34	6	0%	9	0%	6	0%	9	0%
6	NB	23:07	23:20	1	0%	1	0%	1	0%	0	0%
	SB	22:20	22:27	1	0%	1	0%	1	0%	1	0%
7	NB	27:31	27:26	4	0%	4	0%	4	0%	4	0%
	SB	27:44	27:50	-1	0%	-1	0%	4	0%	4	0%
8	NB	31:48	33:20	62	3%	84	4%	103	5%	139	7%
	SB	34:18	38:47	24	1%	52	2%	42	2%	49	2%
9	EB	26:57	27:10	4	0%	4	0%	14	1%	13	1%
	WB	27:22	29:50	-29	-2%	17	1%	-44	-2%	-11	-1%
10	NB	31:26	31:57	0	0%	1	0%	2	0%	3	0%
	SB	32:07	32:57	-1	0%	-1	0%	-1	0%	-1	0%
11	NB	04:40	04:53	1	0%	2	1%	2	1%	2	1%
	SB	06:48	08:10	17	3%	17	3%	24	5%	15	3%
12	NB	08:50	08:55	-2	0%	-2	0%	-3	-1%	-3	-1%
	SB	08:34	09:03	0	0%	-1	0%	0	0%	0	0%
A1	NB	03:21	04:08	16	6%	33	13%	31	13%	52	21%
	SB	03:27	06:20	2	1%	30	8%	12	3%	27	7%
A2	NB	59:47	54:30	60	2%	72	2%	102	3%	120	4%
	SB	53:06	55:02	19	1%	21	1%	41	1%	34	1%
A3	NB	30:25	31:25	-141	-7%	-126	-7%	-97	-5%	-75	-4%
	SB	33:08	35:00	-180	-9%	-181	-9%	-169	-8%	-178	-8%
A4	NB	12:11	12:11	-78	-11%	-77	-11%	-77	-11%	-77	-11%
	SB	12:01	12:01	-64	-9%	-60	-8%	-58	-8%	-56	-8%
A5	NB	09:55	11:16	61	9%	84	12%	-72	-11%	138	20%
	SB	12:37	17:02	22	2%	50	5%	86	8%	47	5%

Table 8E.11 – 2028 Peak Construction – Journey Times 15:00-16:00 hours

Route	Direction	Average Journey Time (mm:ss).		Difference from Reference Case.							
		2015 Base Year.	2028 Reference Case.	Sec-onds	%	Sec-onds	%	Sec-onds	%	Sec-onds	%
				Core.				Cumulative.			
				2028 Peak Construction (Typical Day).		2028 Peak Construction (Busiest Day).		2028 Peak Construction (Typical Day).		2028 Peak Construction (Busiest Day).	
1	EB	20:14	21:52	-1	0%	0	0%	1	0%	4	0%
	WB	19:49	21:28	3	0%	4	0%	4	0%	2	0%
2	NB	31:10	35:30	55	3%	84	4%	84	4%	105	5%
	SB	29:56	35:55	83	4%	91	4%	101	5%	109	5%
3	NB	26:14	26:18	23	1%	23	1%	23	1%	23	1%
	SB	25:59	26:07	11	1%	14	1%	14	1%	14	1%
4	EB	38:55	39:05	-64	-3%	-64	-3%	-64	-3%	-64	-3%
	WB	38:36	38:52	-73	-3%	-73	-3%	-73	-3%	-72	-3%
5	EB	37:33	37:44	-5	0%	-5	0%	-5	0%	-5	0%
	WB	36:58	37:12	9	0%	9	0%	9	0%	9	0%
6	NB	23:13	23:45	6	0%	6	0%	6	0%	6	0%
	SB	22:17	22:22	1	0%	1	0%	1	0%	1	0%
7	NB	27:15	27:17	8	0%	8	0%	8	0%	8	0%
	SB	27:55	27:56	-4	0%	-3	0%	-1	0%	-1	0%
8	NB	33:05	36:30	60	3%	85	4%	81	4%	99	5%
	SB	31:33	36:00	93	4%	97	4%	106	5%	112	5%
9	EB	26:52	27:04	3	0%	4	0%	4	0%	5	0%
	WB	26:56	27:04	10	1%	10	1%	12	1%	12	1%
10	NB	30:50	31:12	0	0%	0	0%	0	0%	0	0%
	SB	31:00	31:36	3	0%	3	0%	3	0%	3	0%
11	NB	05:48	06:56	28	7%	43	10%	41	10%	43	10%
	SB	04:18	06:06	68	19%	68	19%	79	22%	85	23%
12	NB	08:49	08:50	0	0%	0	0%	1	0%	2	0%
	SB	07:58	08:08	1	0%	1	0%	1	0%	1	0%
A1	NB	03:23	03:53	7	3%	9	4%	9	4%	13	6%
	SB	03:24	05:45	15	4%	19	6%	17	5%	17	5%
A2	NB	54:17	56:51	60	2%	82	2%	81	2%	90	3%
	SB	50:21	52:53	76	2%	82	3%	94	3%	103	3%
A3	NB	31:46	34:48	-144	-7%	-122	-6%	-122	-6%	-112	-5%
	SB	30:29	32:55	-118	-6%	-114	-6%	-102	-5%	-93	-5%
A4	NB	12:08	12:11	-74	-10%	-74	-10%	-74	-10%	-73	-10%
	SB	12:00	12:00	-65	-9%	-65	-9%	-65	-9%	-65	-9%
A5	NB	11:09	14:22	62	7%	87	10%	-91	-11%	100	12%
	SB	09:58	14:13	87	10%	91	11%	147	17%	107	13%

Table 8E.12 – 2028 Peak Construction – Journey Times 16:00-17:00 hours

Route	Direction	Average Journey Time (mm:ss).		Difference from Reference Case.							
		2015 Base Year.	2028 Reference Case.	Sec-onds	%	Sec-onds	%	Sec-onds	%	Sec-onds	%
				Core.				Cumulative.			
				2028 Peak Construction (Typical Day).		2028 Peak Construction (Busiest Day).		2028 Peak Construction (Typical Day).		2028 Peak Construction (Busiest Day).	
1	EB	20:58	22:37	1	0%	3	0%	3	0%	4	0%
	WB	21:05	22:45	5	0%	5	0%	5	0%	6	0%
2	NB	32:32	36:09	15	1%	23	1%	23	1%	30	1%
	SB	31:35	38:59	68	3%	87	4%	89	4%	110	5%
3	NB	26:31	26:40	14	1%	16	1%	15	1%	16	1%
	SB	25:57	26:03	9	1%	11	1%	10	1%	11	1%
4	EB	39:03	39:14	-69	-3%	-67	-3%	-68	-3%	-65	-3%
	WB	38:43	39:02	-69	-3%	-65	-3%	-68	-3%	-61	-3%
5	EB	37:43	37:54	-6	0%	-4	0%	-5	0%	-2	0%
	WB	37:03	37:23	16	1%	17	1%	17	1%	21	1%
6	NB	23:22	23:43	2	0%	2	0%	2	0%	2	0%
	SB	22:13	22:16	2	0%	2	0%	2	0%	2	0%
7	NB	27:11	27:19	5	0%	6	0%	6	0%	6	0%
	SB	27:50	27:47	-4	0%	-4	0%	-4	0%	-4	0%
8	NB	33:40	36:20	27	1%	29	1%	30	1%	37	2%
	SB	32:24	38:07	76	3%	90	4%	92	4%	109	5%
9	EB	27:04	27:33	7	0%	10	1%	9	1%	10	1%
	WB	27:16	28:22	21	1%	28	2%	30	2%	39	2%
10	NB	31:04	31:17	2	0%	2	0%	0	0%	1	0%
	SB	31:49	32:41	6	0%	9	0%	9	0%	10	1%
11	NB	06:28	06:55	19	5%	18	4%	19	5%	26	6%
	SB	04:57	07:18	43	10%	52	12%	50	11%	59	13%
12	NB	08:50	08:53	0	0%	1	0%	1	0%	1	0%
	SB	08:12	08:19	8	2%	11	2%	9	2%	12	2%
A1	NB	03:22	03:44	3	1%	4	2%	4	2%	4	2%
	SB	03:26	06:32	28	7%	33	8%	36	9%	44	11%
A2	NB	54:50	57:44	28	1%	37	1%	35	1%	46	1%
	SB	51:13	54:13	44	1%	60	2%	58	2%	71	2%
A3	NB	32:51	35:27	-168	-8%	-160	-8%	-162	-8%	-151	-7%
	SB	31:19	34:18	-148	-7%	-130	-6%	-134	-7%	-119	-6%
A4	NB	12:14	12:17	-71	-10%	-68	-9%	-71	-10%	-68	-9%
	SB	11:57	11:58	-70	-10%	-70	-10%	-70	-10%	-70	-10%
A5	NB	11:55	14:26	28	3%	31	4%	-148	-17%	38	4%
	SB	10:41	16:14	75	8%	90	9%	139	14%	110	11%

Table 8E.13 – 2028 Peak Construction – Journey Times 17:00-18:00 hours

Route	Direction	Average Journey Time (mm:ss).		Difference from Reference Case.							
		2015 Base Year.	2028 Reference Case.	Sec-onds	%	Sec-onds	%	Sec-onds	%	Sec-onds	%
				Core.				Cumulative.			
				2028 Peak Construction (Typical Day).		2028 Peak Construction (Busiest Day).		2028 Peak Construction (Typical Day).		2028 Peak Construction (Busiest Day).	
1	EB	20:59	22:23	3	0%	5	0%	4	0%	6	0%
	WB	20:36	22:29	5	0%	2	0%	5	0%	6	0%
2	NB	32:06	35:50	4	0%	13	1%	24	1%	35	2%
	SB	29:59	35:54	68	3%	91	4%	141	7%	160	7%
3	NB	26:22	26:27	12	1%	13	1%	22	1%	24	2%
	SB	25:51	25:57	10	1%	10	1%	12	1%	13	1%
4	EB	38:59	39:09	-69	-3%	-68	-3%	-68	-3%	-68	-3%
	WB	38:38	38:50	-72	-3%	-72	-3%	-68	-3%	-66	-3%
5	EB	37:40	37:51	-8	0%	-8	0%	-8	0%	-8	0%
	WB	37:01	37:14	14	1%	14	1%	15	1%	15	1%
6	NB	23:12	23:31	4	0%	4	0%	7	0%	7	0%
	SB	22:14	22:16	1	0%	1	0%	1	0%	1	0%
7	NB	27:07	27:10	10	1%	10	1%	14	1%	14	1%
	SB	27:49	27:46	-3	0%	-3	0%	-2	0%	-2	0%
8	NB	33:37	36:33	14	1%	21	1%	30	1%	38	2%
	SB	31:25	35:36	79	4%	102	5%	142	7%	157	7%
9	EB	27:02	27:26	6	0%	7	0%	9	1%	10	1%
	WB	27:10	27:52	21	1%	25	1%	33	2%	36	2%
10	NB	30:54	31:01	0	0%	2	0%	2	0%	2	0%
	SB	31:19	31:54	3	0%	3	0%	7	0%	7	0%
11	NB	06:16	06:55	10	2%	15	4%	25	6%	30	7%
	SB	04:11	04:31	60	22%	74	27%	102	38%	109	40%
12	NB	08:50	08:53	0	0%	0	0%	0	0%	0	0%
	SB	08:10	08:13	1	0%	3	1%	5	1%	5	1%
A1	NB	03:26	03:53	4	2%	4	2%	4	2%	5	2%
	SB	03:24	06:53	12	3%	21	5%	27	7%	31	8%
A2	NB	54:08	56:57	14	0%	22	1%	41	1%	52	2%
	SB	49:58	50:55	63	2%	80	3%	125	4%	139	5%
A3	NB	32:09	34:50	-182	-9%	-173	-8%	-162	-8%	-153	-7%
	SB	30:09	31:03	-127	-7%	-110	-6%	-65	-3%	-50	-3%
A4	NB	12:12	12:13	-71	-10%	-71	-10%	-68	-9%	-66	-9%
	SB	11:56	11:57	-69	-10%	-68	-9%	-67	-9%	-67	-9%
A5	NB	11:41	14:26	15	2%	22	3%	-136	-16%	39	5%
	SB	09:49	13:45	74	9%	98	12%	182	22%	150	18%

Table 8E.14 – 2028 Peak Construction – Journey Times 18:00-19:00 hours

Route	Direction	Average Journey Time (mm:ss).		Difference from Reference Case.							
		2015 Base Year.	2028 Reference Case.	Sec-onds	%	Sec-onds	%	Sec-onds	%	Sec-onds	%
				Core.				Cumulative.			
				2028 Peak Construction (Typical Day).		2028 Peak Construction (Busiest Day).		2028 Peak Construction (Typical Day).		2028 Peak Construction (Busiest Day).	
1	EB	19:18	20:04	3	0%	1	0%	3	0%	5	0%
	WB	19:02	19:41	7	1%	7	1%	8	1%	9	1%
2	NB	29:06	30:33	-8	0%	-8	0%	1	0%	2	0%
	SB	28:14	30:06	34	2%	41	2%	46	3%	58	3%
3	NB	25:50	25:56	18	1%	18	1%	18	1%	19	1%
	SB	25:41	25:44	12	1%	13	1%	13	1%	14	1%
4	EB	38:45	38:51	-69	-3%	-69	-3%	-69	-3%	-69	-3%
	WB	38:28	38:34	-73	-3%	-73	-3%	-73	-3%	-73	-3%
5	EB	37:21	37:31	-8	0%	-8	0%	-8	0%	-8	0%
	WB	36:48	36:57	10	0%	10	0%	10	0%	10	0%
6	NB	22:47	22:56	3	0%	3	0%	3	0%	3	0%
	SB	22:06	22:08	2	0%	2	0%	2	0%	2	0%
7	NB	26:57	26:57	14	1%	14	1%	14	1%	15	1%
	SB	27:36	27:36	-3	0%	-3	0%	-3	0%	-3	0%
8	NB	31:35	32:14	4	0%	4	0%	8	0%	8	0%
	SB	30:45	31:40	42	2%	47	2%	49	3%	54	3%
9	EB	26:51	26:56	1	0%	1	0%	1	0%	1	0%
	WB	26:55	27:02	7	0%	8	0%	8	0%	7	0%
10	NB	30:26	30:31	2	0%	2	0%	2	0%	2	0%
	SB	30:38	30:54	0	0%	0	0%	0	0%	0	0%
11	NB	04:38	04:48	3	1%	3	1%	4	1%	4	1%
	SB	03:52	04:04	10	4%	11	5%	11	5%	12	5%
12	NB	08:42	08:44	-1	0%	-1	0%	-1	0%	-1	0%
	SB	07:55	07:58	0	0%	0	0%	0	0%	0	0%
A1	NB	03:18	03:34	0	0%	0	0%	2	1%	2	1%
	SB	03:17	03:44	16	7%	19	8%	20	9%	23	10%
A2	NB	50:48	51:30	12	0%	12	0%	17	1%	20	1%
	SB	49:00	49:42	21	1%	25	1%	26	1%	34	1%
A3	NB	30:12	30:55	-189	-10%	-188	-10%	-182	-10%	-181	-10%
	SB	29:23	30:06	-172	-10%	-167	-9%	-167	-9%	-158	-9%
A4	NB	12:09	12:12	-69	-9%	-69	-9%	-69	-9%	-69	-9%
	SB	11:53	11:57	-68	-9%	-68	-9%	-68	-9%	-68	-9%
A5	NB	09:51	10:22	4	1%	5	1%	-164	-26%	8	1%
	SB	09:11	09:57	33	6%	38	6%	88	15%	44	7%

Table 8E.15 – 2034 Operational Traffic – Journey Times 06:00-07:00 hours

Route	Direction	Average Journey Time (mm:ss).		Difference from Reference Case.	
		2015 Base Year.	2034 Reference Case.	Seconds	%
				2034 Operational Traffic.	
1	EB	18:27	18:44	0	0%
	WB	18:35	19:04	0	0%
2	NB	27:25	27:58	-10	-1%
	SB	27:36	28:45	-14	-1%
3	NB	25:31	25:32	4	0%
	SB	25:36	25:40	9	1%
4	EB	38:40	38:44	-70	-3%
	WB	38:24	38:26	-79	-3%
5	EB	37:15	37:15	-6	0%
	WB	36:42	36:45	5	0%
6	NB	22:38	22:41	0	0%
	SB	22:00	22:04	0	0%
7	NB	26:49	26:51	3	0%
	SB	27:26	27:29	-3	0%
8	NB	30:36	30:57	3	0%
	SB	30:19	30:48	2	0%
9	EB	26:44	26:44	0	0%
	WB	26:49	26:52	0	0%
10	NB	30:11	30:19	0	0%
	SB	30:17	30:28	0	0%
11	NB	04:08	04:08	-1	0%
	SB	03:40	03:44	-1	0%
12	NB	08:36	08:38	0	0%
	SB	07:50	07:52	0	0%
A1	NB	03:09	03:16	0	0%
	SB	03:13	03:26	0	0%
A2	NB	49:33	49:44	-6	0%
	SB	48:31	48:54	-6	0%
A3	NB	29:13	29:33	-193	-11%
	SB	29:05	29:23	-198	-11%
A4	NB	12:06	12:07	-78	-11%
	SB	11:55	11:59	-70	-10%
A5	NB	08:59	09:10	2	0%
	SB	08:52	09:14	0	0%

Table 8E.16 – 2034 Operational Traffic – Journey Times 07:00-08:00 hours

Route	Direction	Average Journey Time (mm:ss).		Difference from Reference Case.	
		2015 Base Year.	2034 Reference Case.	Seconds	%
				2034 Operational Traffic.	
1	EB	19:59	21:57	0	0%
	WB	20:10	22:00	0	0%
2	NB	29:14	31:54	-11	-1%
	SB	29:55	35:15	-18	-1%
3	NB	25:45	26:02	3	0%
	SB	26:06	26:06	8	1%
4	EB	38:53	39:05	-70	-3%
	WB	38:44	38:54	-78	-3%
5	EB	37:23	37:34	-5	0%
	WB	37:01	37:14	5	0%
6	NB	22:55	23:07	0	0%
	SB	22:18	22:26	0	0%
7	NB	27:06	27:12	3	0%
	SB	27:43	27:47	-6	0%
8	NB	31:25	32:29	17	1%
	SB	31:37	35:19	3	0%
9	EB	26:52	26:58	0	0%
	WB	27:06	27:33	-2	0%
10	NB	31:07	31:40	0	0%
	SB	31:32	32:17	0	0%
11	NB	04:31	04:48	1	0%
	SB	04:22	07:14	-1	0%
12	NB	08:45	08:47	0	0%
	SB	07:57	08:04	0	0%
A1	NB	03:17	03:38	0	0%
	SB	03:22	03:55	0	0%
A2	NB	57:36	54:13	-28	-1%
	SB	50:24	53:44	-10	0%
A3	NB	30:03	31:10	-203	-11%
	SB	30:26	33:49	-205	-10%
A4	NB	12:09	12:11	-77	-11%
	SB	12:01	12:03	-70	-10%
A5	NB	09:38	10:30	6	1%
	SB	09:57	13:31	0	0%

Table 8E.17 – 2034 Operational Traffic – Journey Times 08:00-09:00 hours

Route	Direction	Average Journey Time (mm:ss).		Difference from Reference Case.	
		2015 Base Year.	2034 Reference Case.	Seconds	%
				2034 Operational Traffic.	
1	EB	21:06	23:15	-10	-1%
	WB	20:35	22:35	5	0%
2	NB	30:23	34:58	-8	0%
	SB	32:58	42:03	-126	-5%
3	NB	25:55	26:05	8	1%
	SB	26:08	26:12	10	1%
4	EB	39:00	39:12	-68	-3%
	WB	38:57	39:23	-72	-3%
5	EB	37:35	37:50	-5	0%
	WB	37:17	37:51	3	0%
6	NB	23:07	23:30	0	0%
	SB	22:20	22:29	0	0%
7	NB	27:31	27:26	3	0%
	SB	27:44	27:53	-3	0%
8	NB	31:48	34:53	14	1%
	SB	34:18	41:38	-97	-4%
9	EB	26:57	27:30	-7	0%
	WB	27:22	32:43	-114	-6%
10	NB	31:26	32:15	-4	0%
	SB	32:07	33:14	-2	0%
11	NB	04:40	04:53	1	0%
	SB	06:48	08:45	-20	-4%
12	NB	08:50	08:54	1	0%
	SB	08:34	09:12	-10	-2%
A1	NB	03:21	05:49	-41	-12%
	SB	03:27	08:18	-67	-13%
A2	NB	59:47	56:11	304	9%
	SB	53:06	55:53	-44	-1%
A3	NB	30:25	31:23	-147	-8%
	SB	33:08	35:51	-241	-11%
A4	NB	12:11	12:11	-68	-9%
	SB	12:01	12:02	-67	-9%
A5	NB	09:55	12:36	18	2%
	SB	12:37	19:35	-85	-7%

Table 8E.18 – 2034 Operational Traffic – Journey Times 15:00-16:00 hours

Route	Direction	Average Journey Time (mm:ss).		Difference from Reference Case.	
		2015 Base Year.	2034 Reference Case.	Seconds	%
				2034 Operational Traffic.	
1	EB	20:14	22:36	-2	0%
	WB	19:49	22:05	1	0%
2	NB	31:10	37:25	-4	0%
	SB	29:56	38:24	-21	-1%
3	NB	26:14	26:23	5	0%
	SB	25:59	26:10	10	1%
4	EB	38:55	39:08	-70	-3%
	WB	38:36	38:57	-80	-3%
5	EB	37:33	37:46	-6	0%
	WB	36:58	37:19	4	0%
6	NB	23:13	24:00	0	0%
	SB	22:17	22:23	0	0%
7	NB	27:15	27:20	3	0%
	SB	27:55	27:59	-4	0%
8	NB	33:05	38:06	14	1%
	SB	31:33	38:11	3	0%
9	EB	26:52	27:11	2	0%
	WB	26:56	27:18	2	0%
10	NB	30:50	31:22	0	0%
	SB	31:00	32:01	0	0%
11	NB	05:48	07:46	-1	0%
	SB	04:18	07:15	0	0%
12	NB	08:49	08:52	-1	0%
	SB	07:58	08:10	0	0%
A1	NB	03:23	04:12	-4	-2%
	SB	03:24	06:40	1	0%
A2	NB	54:17	58:45	-17	0%
	SB	50:21	54:19	-13	0%
A3	NB	31:46	36:06	-206	-10%
	SB	30:29	34:14	-210	-10%
A4	NB	12:08	12:11	-78	-11%
	SB	12:00	12:01	-70	-10%
A5	NB	11:09	15:54	13	1%
	SB	09:58	16:18	2	0%

Table 8E.19 – 2034 Operational Traffic – Journey Times 16:00-17:00 hours

Route	Direction	Average Journey Time (mm:ss).		Difference from Reference Case.	
		2015 Base Year.	2034 Reference Case.	Seconds	%
				2034 Operational Traffic.	
1	EB	20:58	23:30	-1	0%
	WB	21:05	23:16	-1	0%
2	NB	32:32	36:41	-13	-1%
	SB	31:35	41:58	-21	-1%
3	NB	26:31	26:42	3	0%
	SB	25:57	26:06	10	1%
4	EB	39:03	39:28	-63	-3%
	WB	38:43	39:14	-76	-3%
5	EB	37:43	38:09	-12	-1%
	WB	37:03	37:34	15	1%
6	NB	23:22	24:01	0	0%
	SB	22:13	22:17	0	0%
7	NB	27:11	27:19	5	0%
	SB	27:50	27:50	-4	0%
8	NB	33:40	36:41	7	0%
	SB	32:24	40:39	18	1%
9	EB	27:04	27:59	1	0%
	WB	27:16	29:21	-1	0%
10	NB	31:04	31:25	0	0%
	SB	31:49	33:13	0	0%
11	NB	06:28	07:09	1	0%
	SB	04:57	08:18	1	0%
12	NB	08:50	08:53	0	0%
	SB	08:12	08:31	0	0%
A1	NB	03:22	03:47	0	0%
	SB	03:26	08:00	-3	-1%
A2	NB	54:50	58:01	-10	0%
	SB	51:13	55:33	-9	0%
A3	NB	32:51	35:42	-198	-9%
	SB	31:19	35:35	-202	-9%
A4	NB	12:14	12:18	-72	-10%
	SB	11:57	11:58	-60	-8%
A5	NB	11:55	14:43	7	1%
	SB	10:41	18:47	-2	0%

Table 8E.20 – 2034 Operational Traffic – Journey Times 17:00-18:00 hours

Route	Direction	Average Journey Time (mm:ss).		Difference from Reference Case.	
		2015 Base Year.	2034 Reference Case.	Seconds	%
				2034 Operational Traffic.	
1	EB	20:59	23:24	-2	0%
	WB	20:36	23:11	-1	0%
2	NB	32:06	37:07	-18	-1%
	SB	29:59	38:56	-12	-1%
3	NB	26:22	26:26	3	0%
	SB	25:51	26:01	10	1%
4	EB	38:59	39:11	-75	-3%
	WB	38:38	39:01	-82	-4%
5	EB	37:40	37:53	-8	0%
	WB	37:01	37:26	7	0%
6	NB	23:12	23:48	0	0%
	SB	22:14	22:17	0	0%
7	NB	27:07	27:12	3	0%
	SB	27:49	27:48	-4	0%
8	NB	33:37	37:22	0	0%
	SB	31:25	38:11	9	0%
9	EB	27:02	27:49	1	0%
	WB	27:10	29:01	7	0%
10	NB	30:54	31:07	0	0%
	SB	31:19	32:19	1	0%
11	NB	06:16	06:58	1	0%
	SB	04:11	05:35	8	2%
12	NB	08:50	08:54	0	0%
	SB	08:10	08:17	-1	0%
A1	NB	03:26	04:03	1	0%
	SB	03:24	06:58	3	1%
A2	NB	54:08	57:36	-14	0%
	SB	49:58	53:36	-5	0%
A3	NB	32:09	35:30	-202	-9%
	SB	30:09	33:38	-203	-10%
A4	NB	12:12	12:14	-76	-10%
	SB	11:56	11:57	-75	-10%
A5	NB	11:41	15:15	0	0%
	SB	09:49	16:18	8	1%

Table 8E.21 – 2034 Operational Traffic – Journey Times 18:00-19:00 hours

Route	Direction	Average Journey Time (mm:ss).		Difference from Reference Case.	
		2015 Base Year.	2034 Reference Case.	Seconds	%
				2034 Operational Traffic.	
1	EB	19:18	20:25	-2	0%
	WB	19:02	20:01	0	0%
2	NB	29:06	31:04	-21	-1%
	SB	28:14	30:52	-17	-1%
3	NB	25:50	25:56	4	0%
	SB	25:41	25:48	10	1%
4	EB	38:45	38:53	-75	-3%
	WB	38:28	38:34	-78	-3%
5	EB	37:21	37:33	-9	0%
	WB	36:48	36:57	10	0%
6	NB	22:47	22:57	0	0%
	SB	22:06	22:09	1	0%
7	NB	26:57	26:57	3	0%
	SB	27:36	27:38	-4	0%
8	NB	31:35	32:28	-1	0%
	SB	30:45	32:04	3	0%
9	EB	26:51	26:57	1	0%
	WB	26:55	27:04	0	0%
10	NB	30:26	30:38	0	0%
	SB	30:38	30:58	0	0%
11	NB	04:38	04:53	0	0%
	SB	03:52	04:07	0	0%
12	NB	08:42	08:44	-1	0%
	SB	07:55	07:58	0	0%
A1	NB	03:18	03:39	-1	0%
	SB	03:17	04:01	0	0%
A2	NB	50:48	51:48	-14	0%
	SB	49:00	50:00	-7	0%
A3	NB	30:12	31:10	-203	-11%
	SB	29:23	30:20	-204	-11%
A4	NB	12:09	12:12	-74	-10%
	SB	11:53	11:57	-74	-10%
A5	NB	09:51	10:34	-1	0%
	SB	09:11	10:21	0	0%

Modelled Journey Times Graphs

Route 1

Figure 8E.1 – Route 1 Eastbound – 08:00-09:00 hours

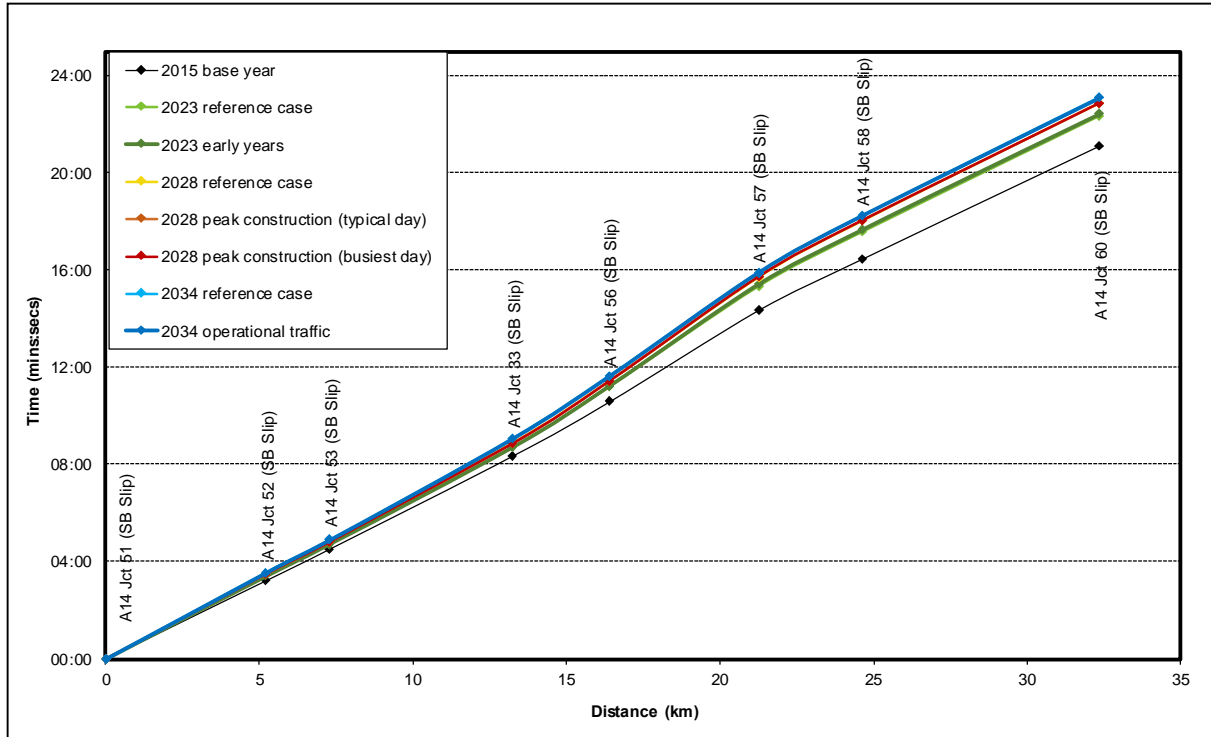
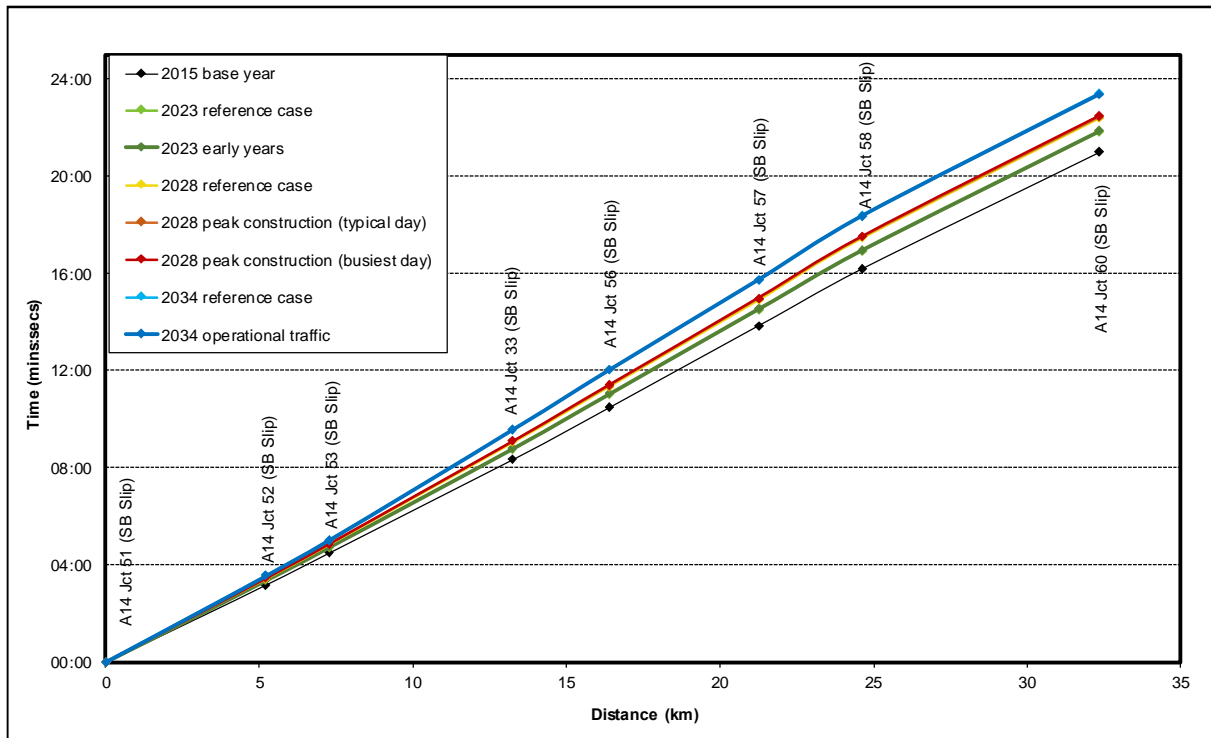

Figure 8E.2 – Route 1 Eastbound – 17:00-18:00 hours



Route 5

Figure 8E.17 – Route 5 Eastbound – 08:00-09:00 hours

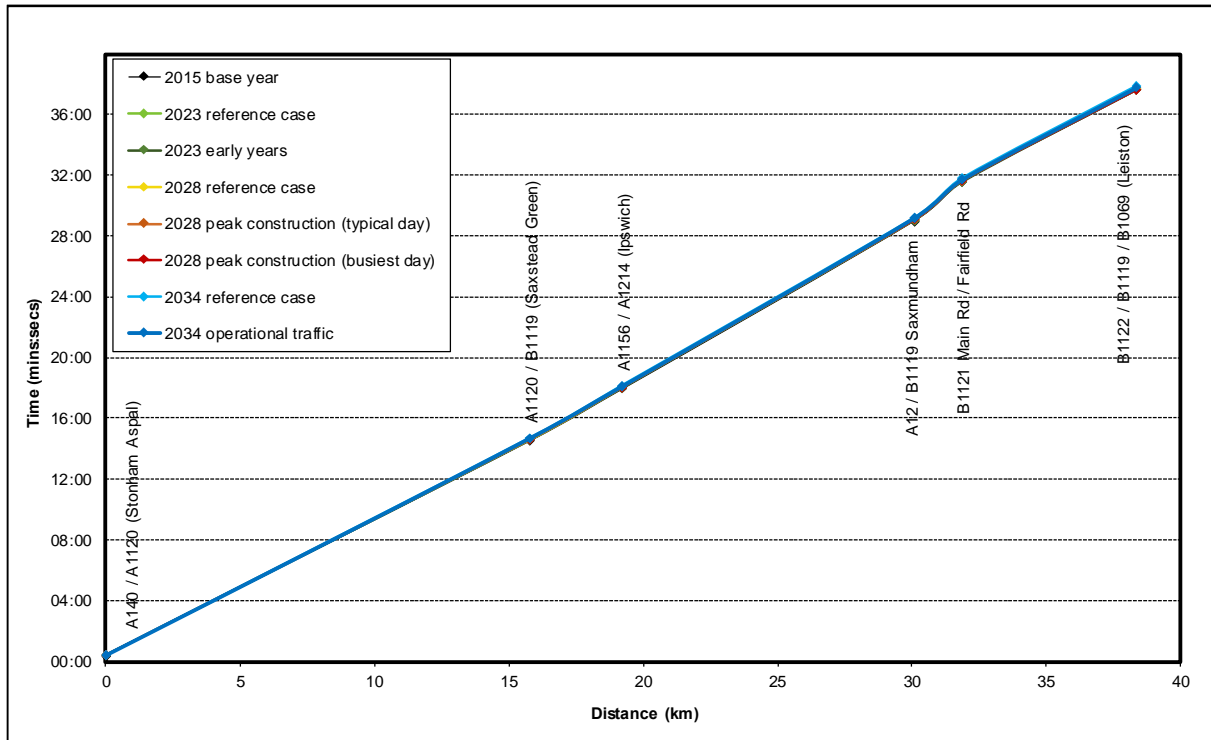
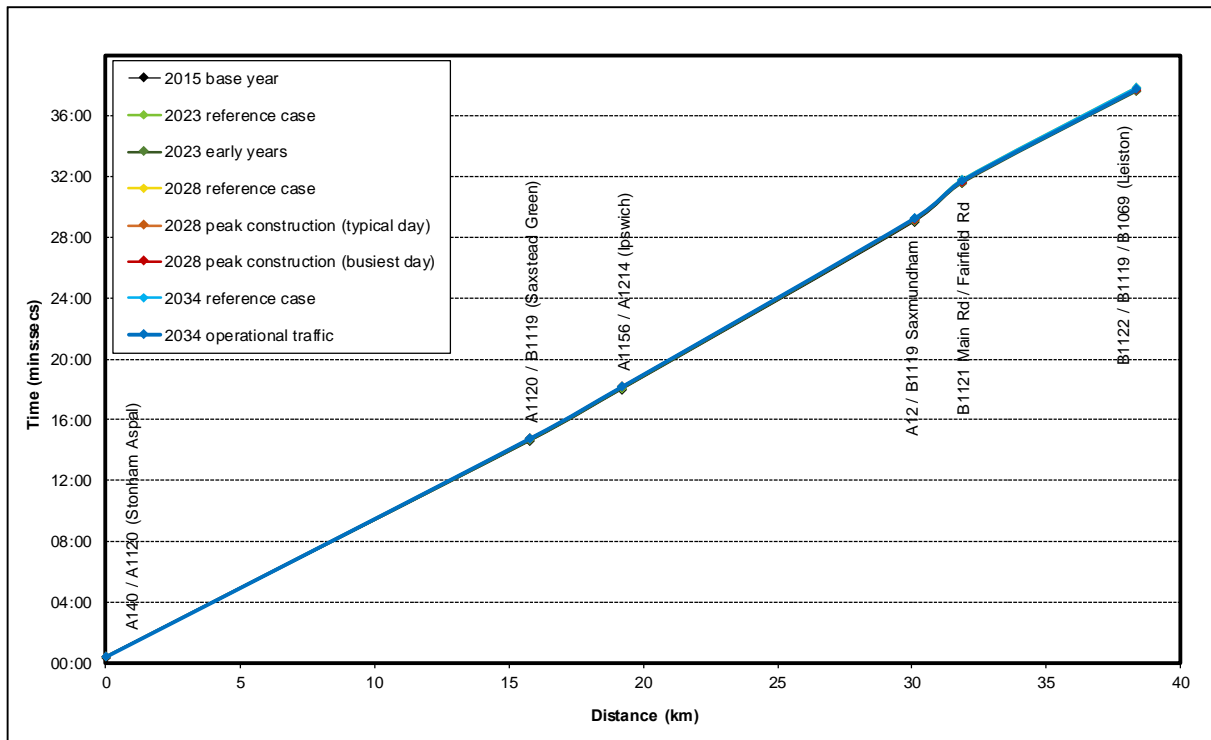

Figure 8E.18 – Route 5 Eastbound – 17:00-18:00 hours



Route 6

Figure 8E.21 – Route 6 Northbound – 08:00-09:00 hours

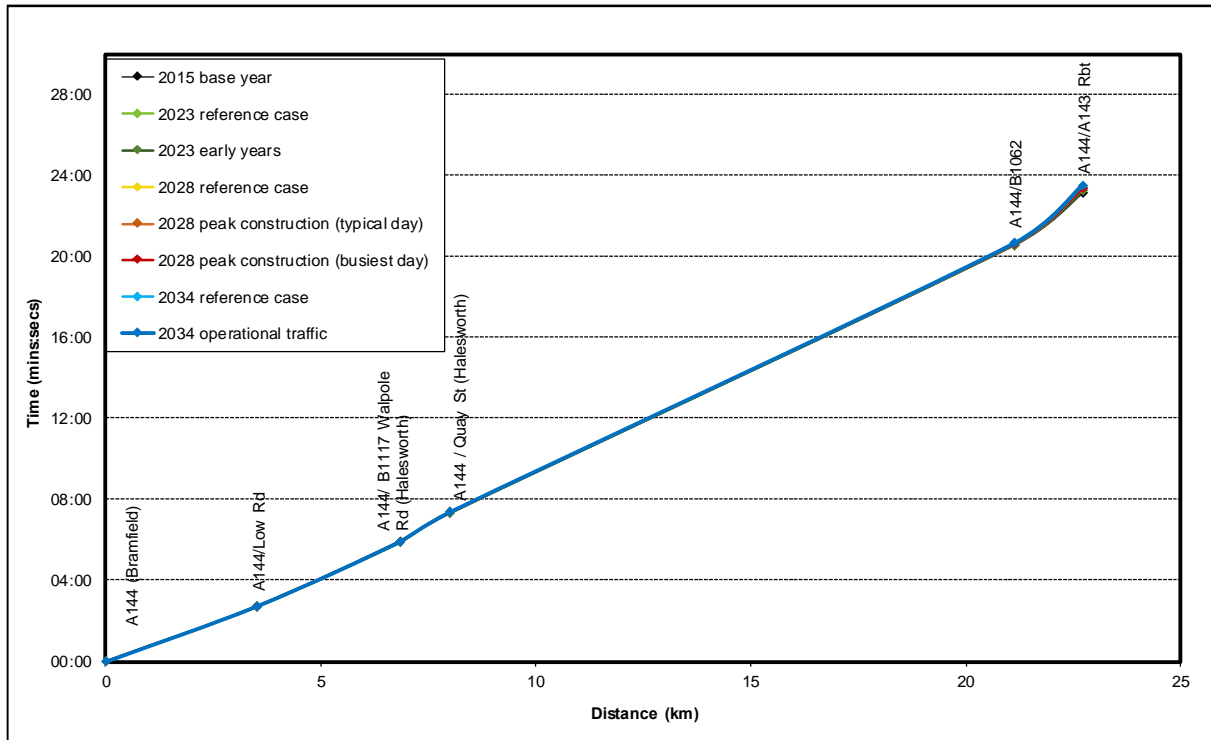

Figure 8E.22 – Route 6 Northbound – 17:00-18:00 hours

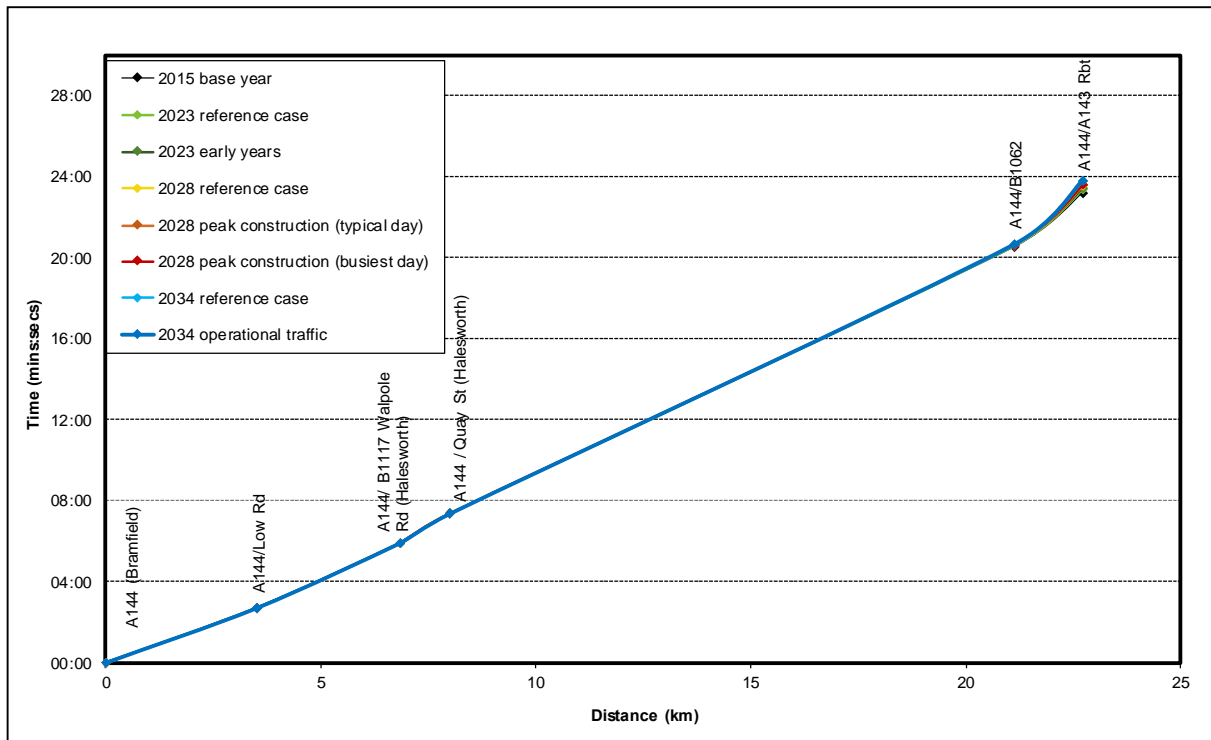

Figure 8E.27 – Route 7 Southbound – 08:00-09:00 hours

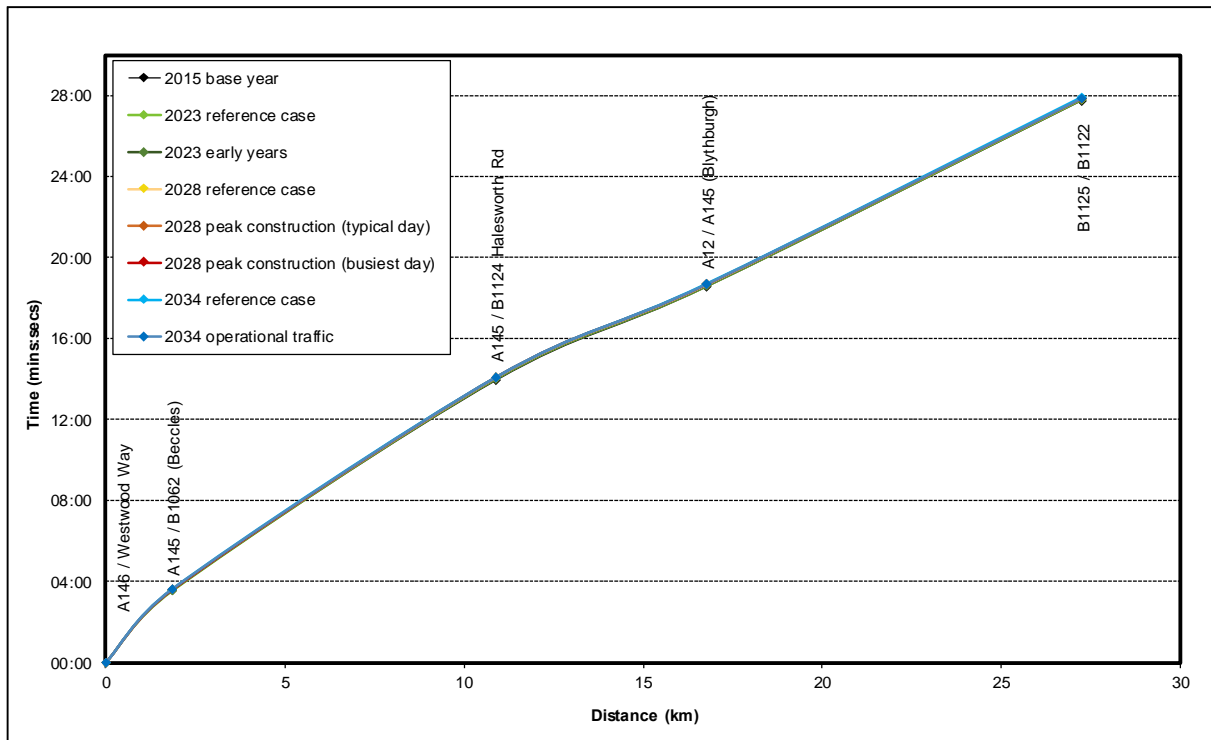

Figure 8E.28 – Route 7 Southbound – 17:00-18:00 hours

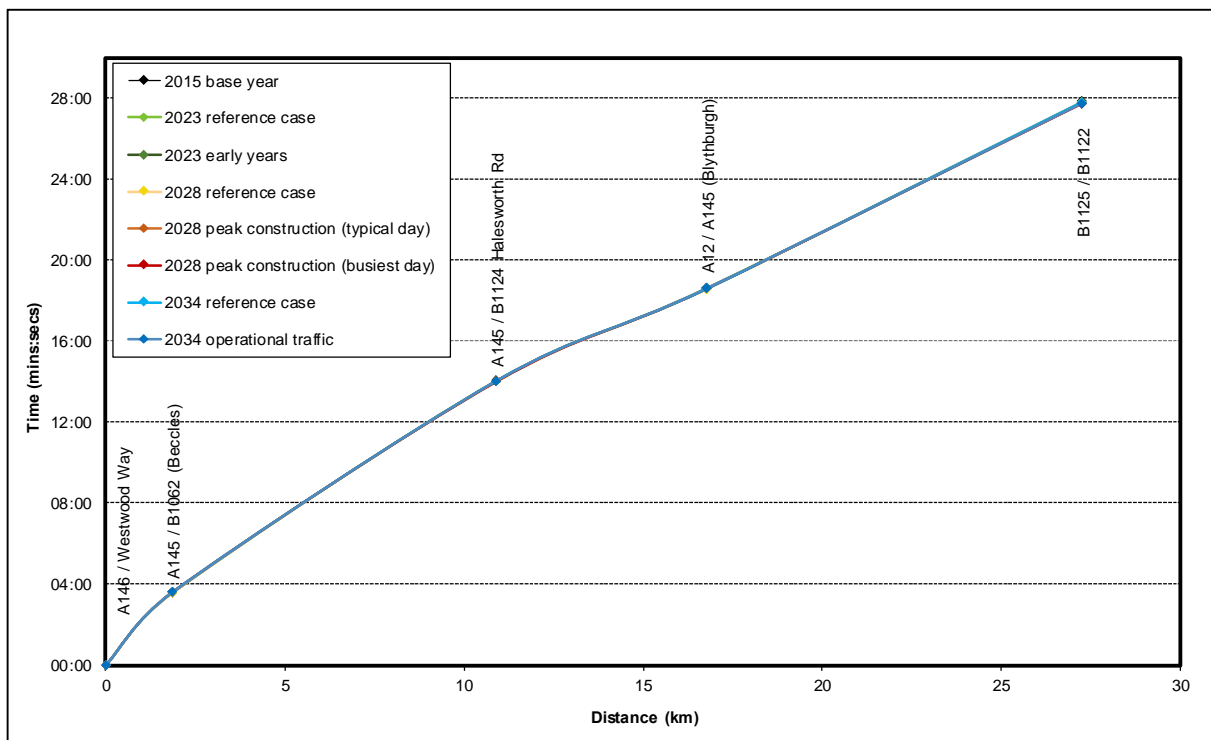

Figure 8E.31 – Route 8 Southbound – 08:00-09:00 hours

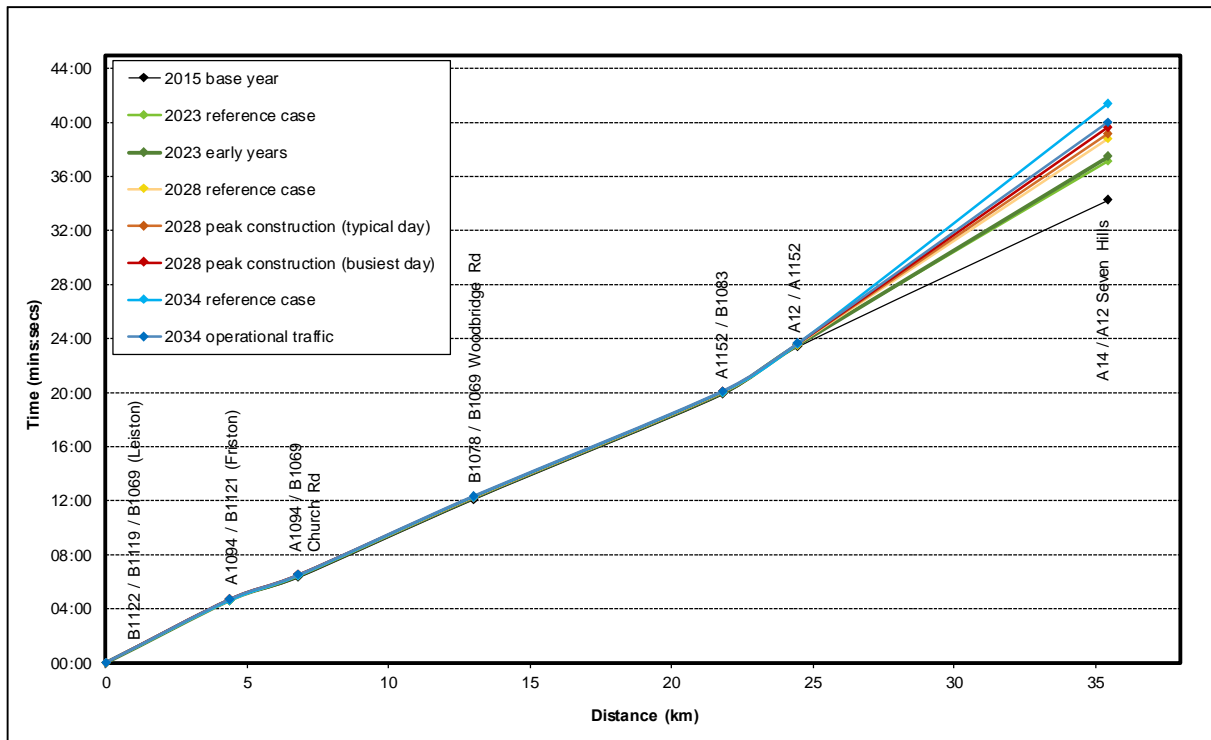

Figure 8E.32 – Route 8 Southbound – 17:00-18:00 hours

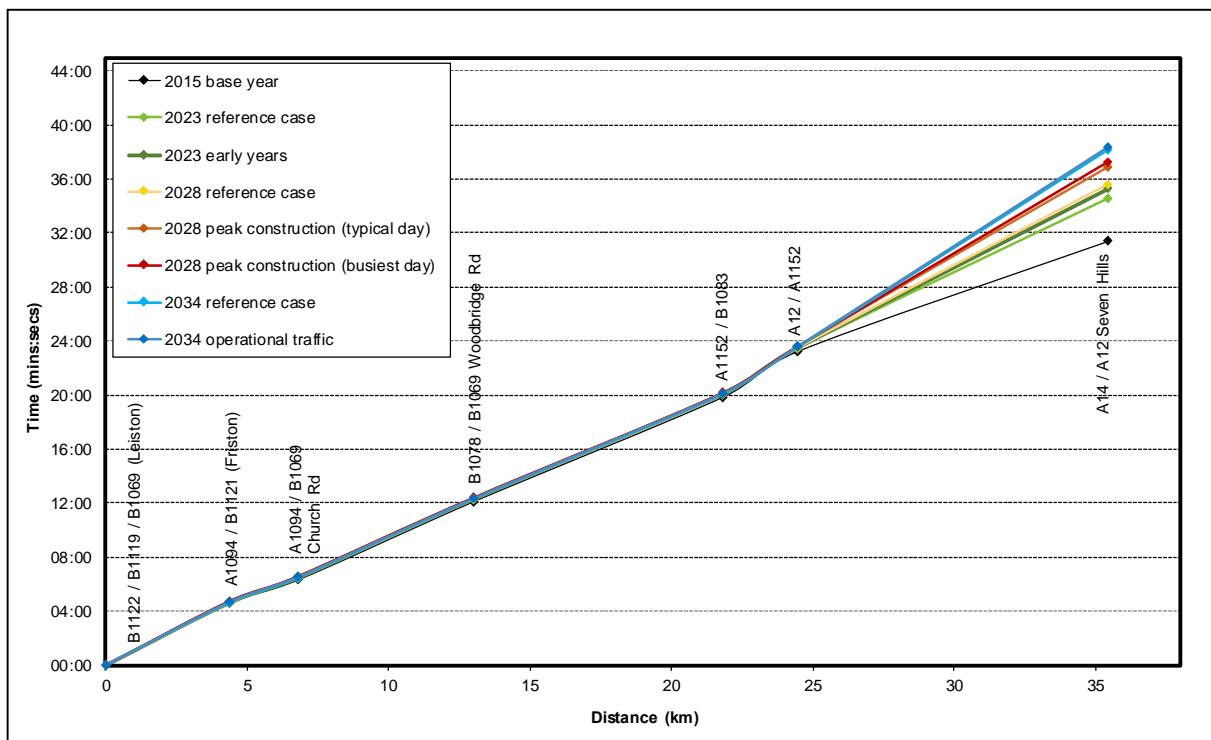

Figure 8E.35 – Route 9 Westbound – 08:00-09:00 hours

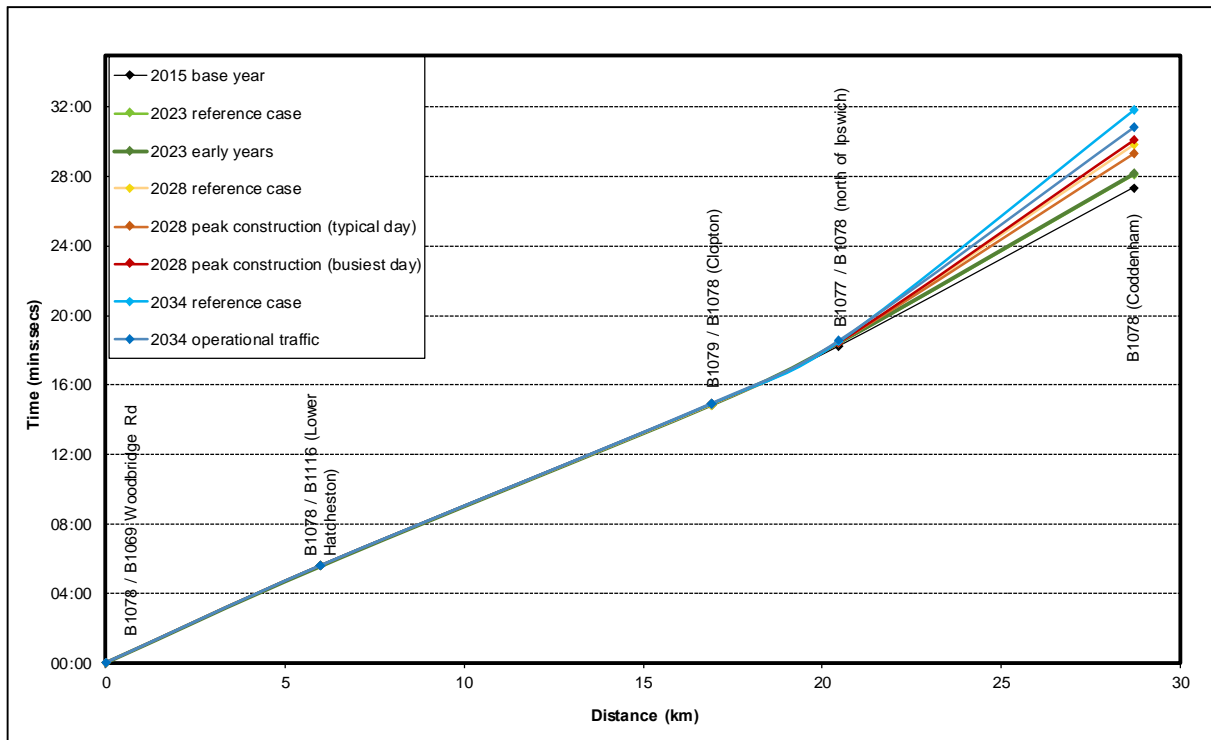

Figure 8E.36 – Route 9 Westbound – 17:00-18:00 hours

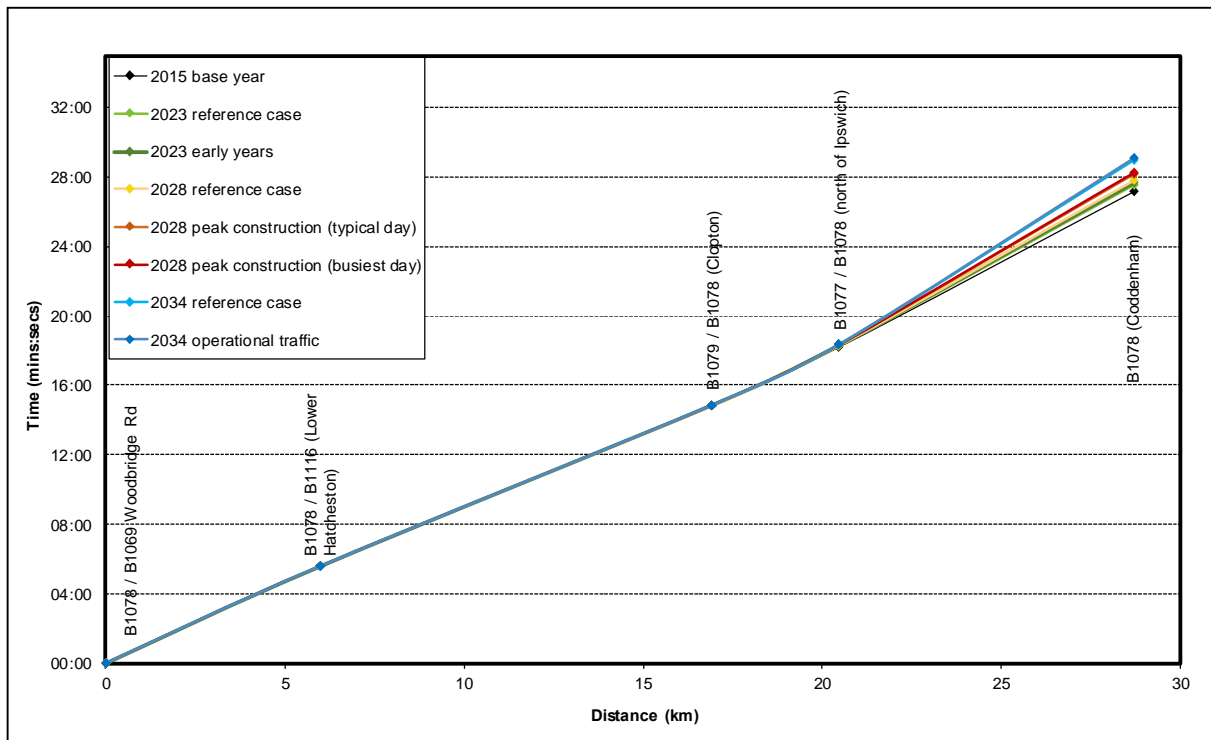

Figure 8E.43 – Route 11 Southbound – 08:00-09:00 hours

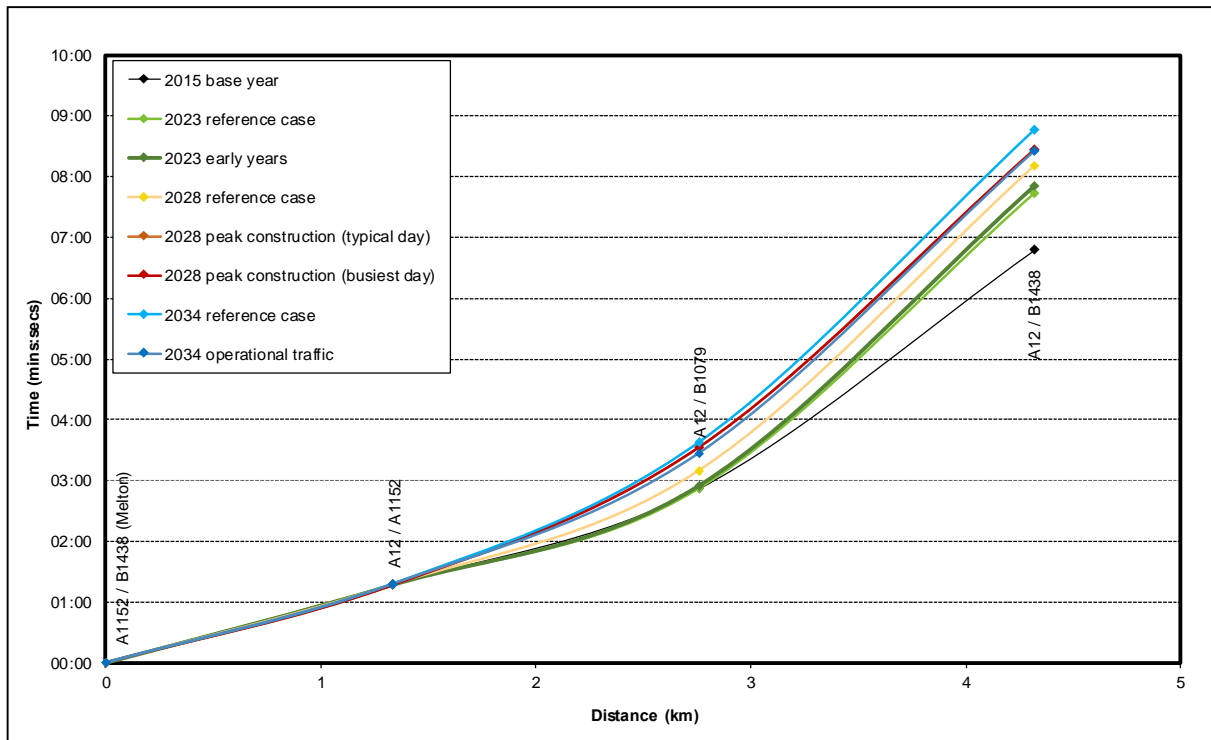

Figure 8E.44 – Route 11 Southbound – 17:00-18:00 hours

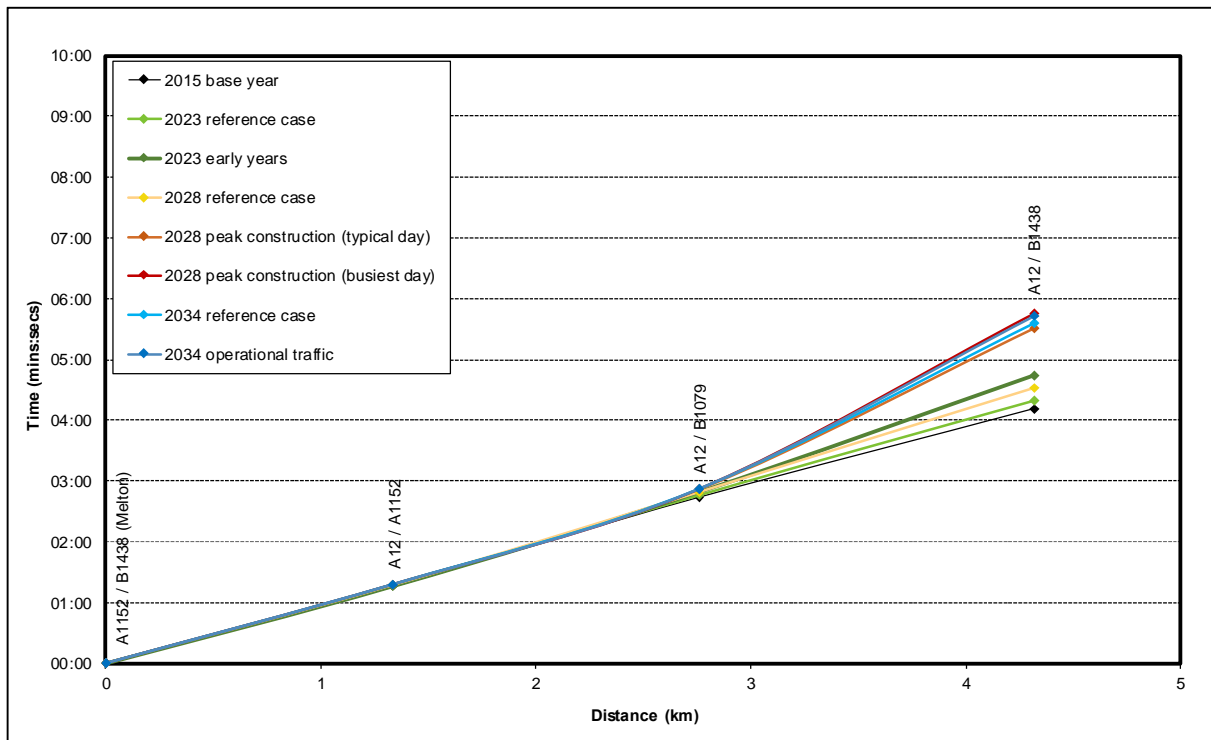

Figure 8E.51 – Route A1 Southbound – 08:00-09:00 hours

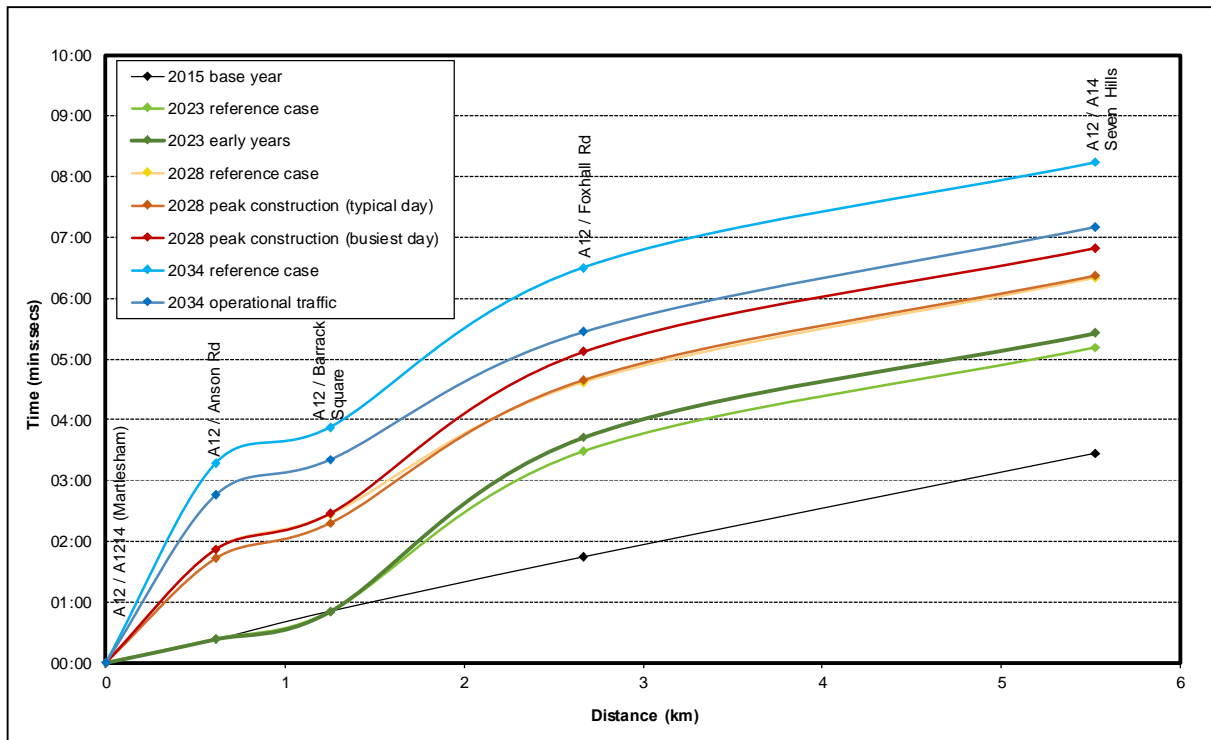
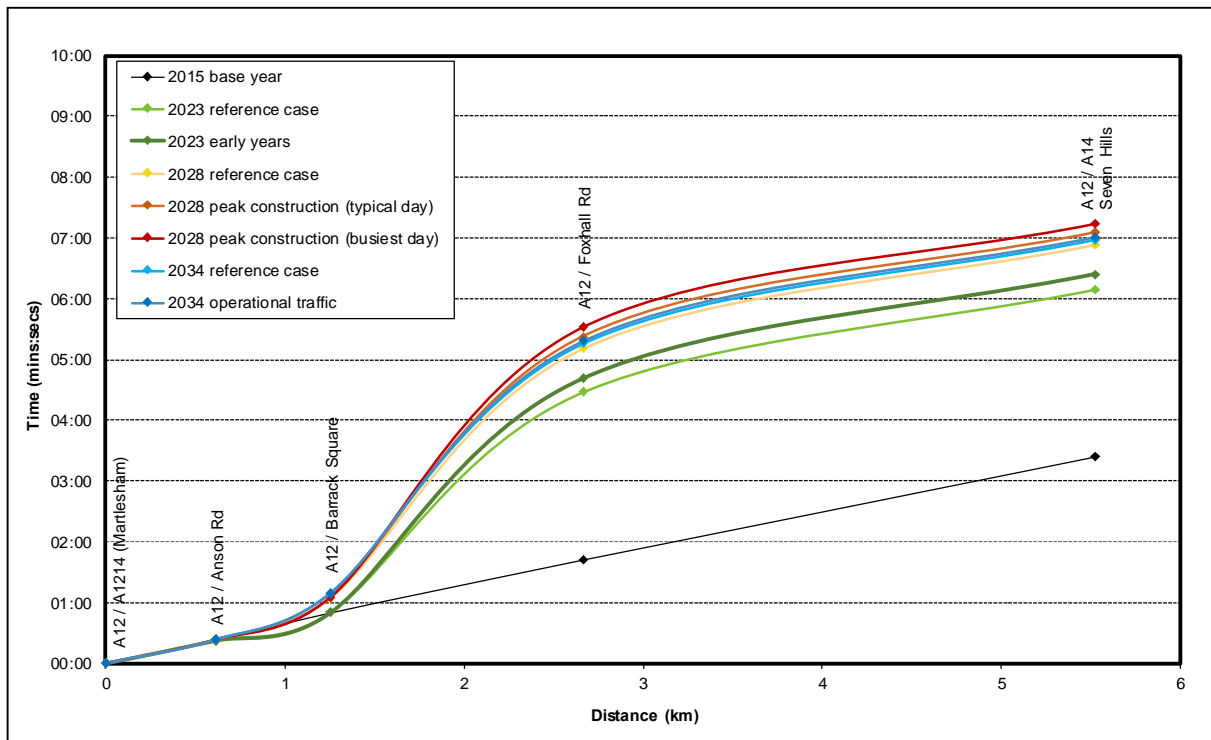

Figure 8E.52 – Route A1 Southbound – 17:00-18:00 hours



Route A2

Figure 8E.53 – Route A2 Northbound – 08:00-09:00 hours

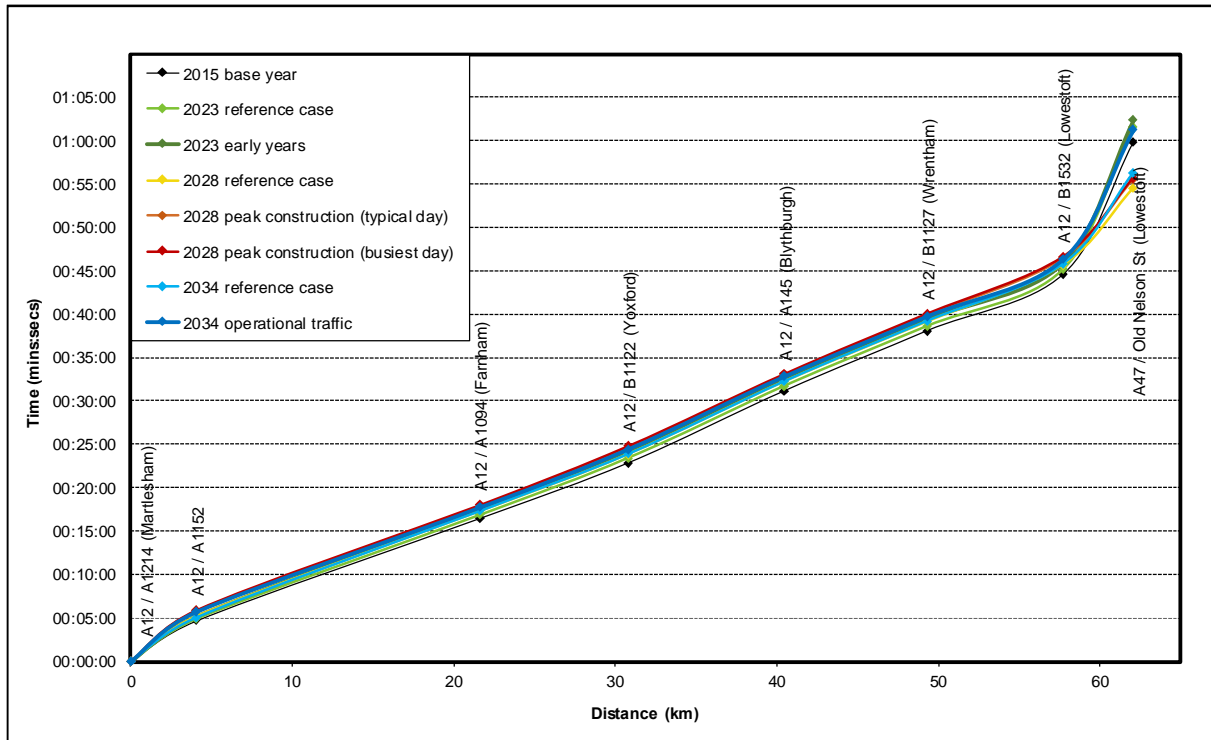
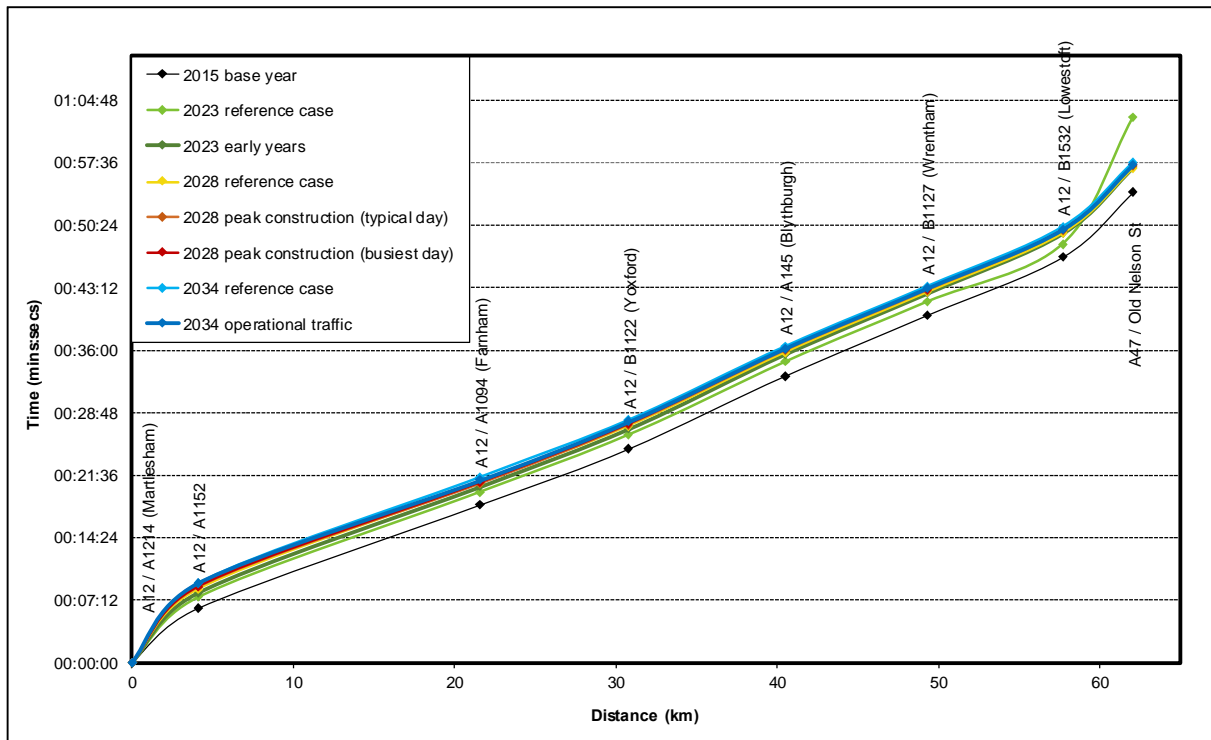

Figure 8E.54 – Route A2 Northbound – 17:00-18:00 hours



Route A3

Figure 8E.57 – Route A3 Northbound – 08:00-09:00 hours

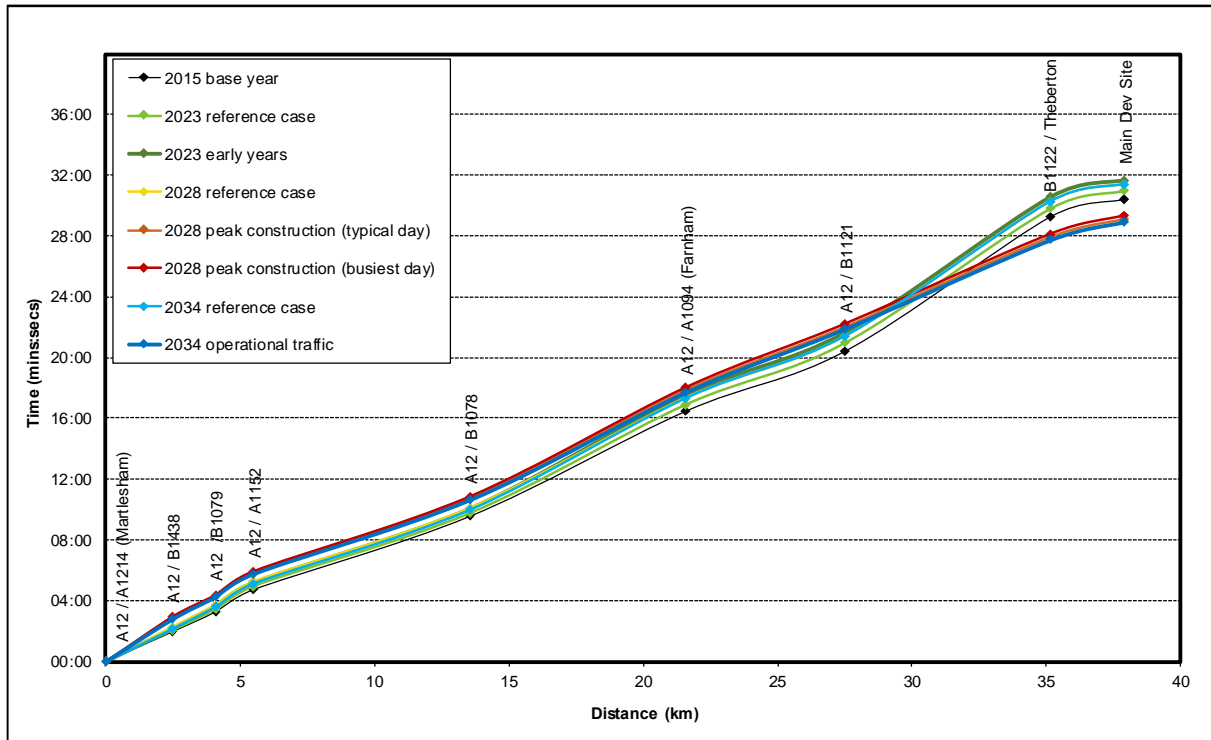

Figure 8E.58 – Route A3 Northbound – 17:00-18:00 hours

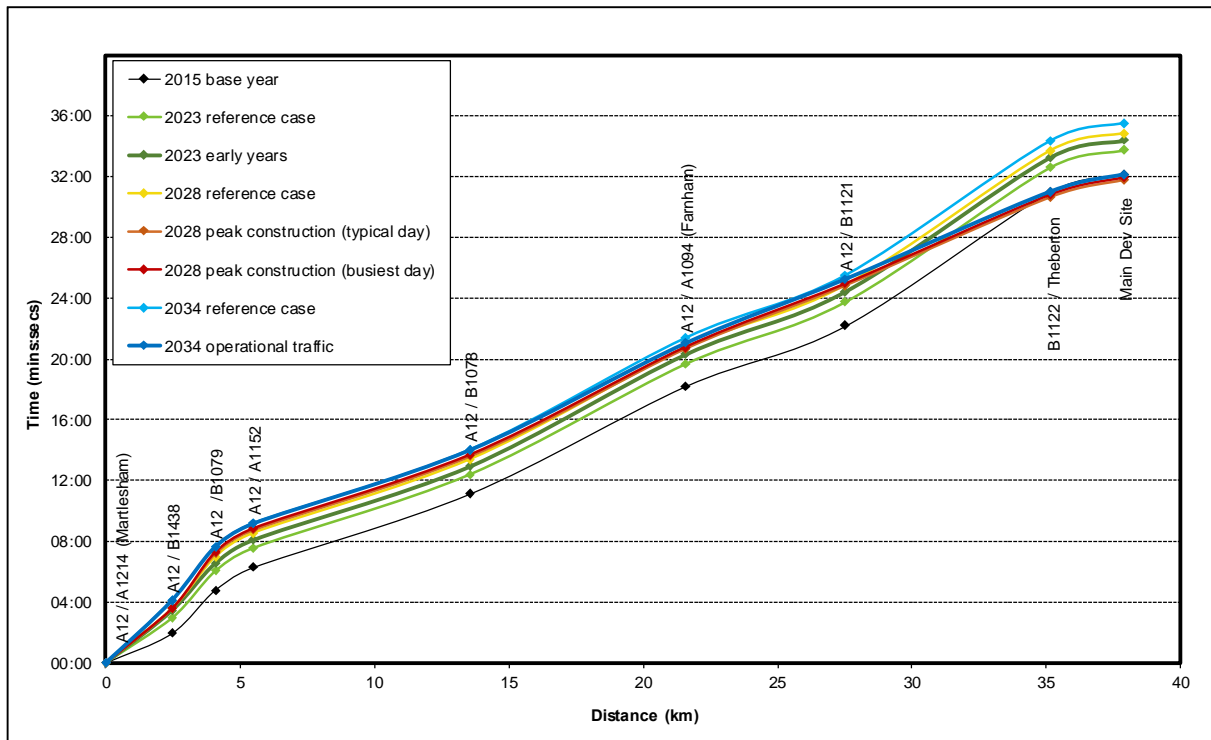

Figure 8E.59 – Route A3 Southbound – 08:00-09:00 hours

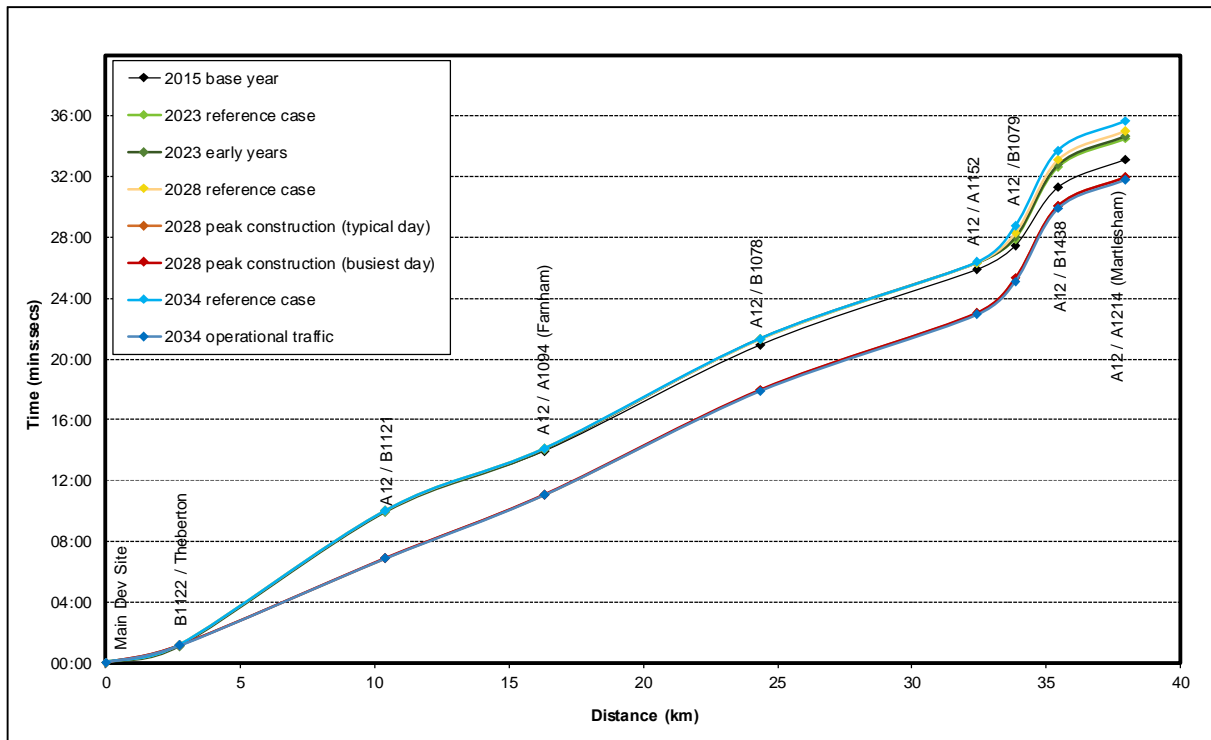

Figure 8E.60 – Route A3 Southbound – 17:00-18:00 hours

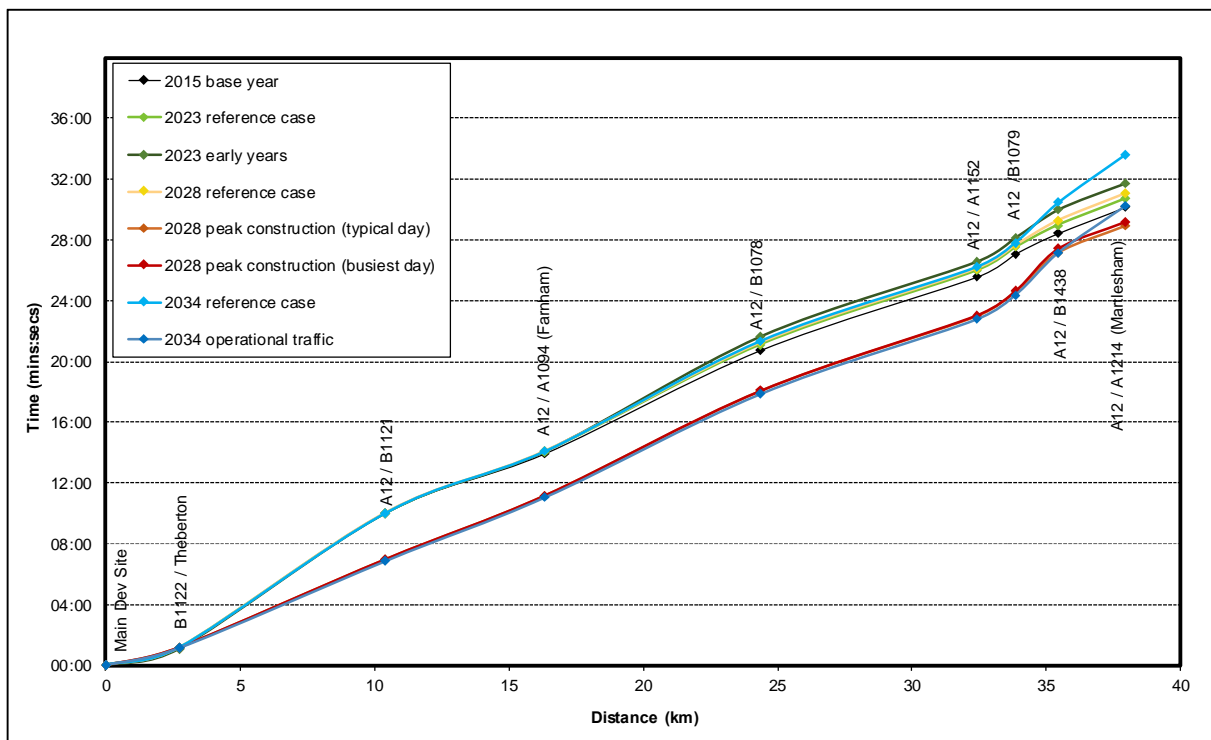

Figure 8E.67 – Route A5 Southbound – 08:00-09:00 hours

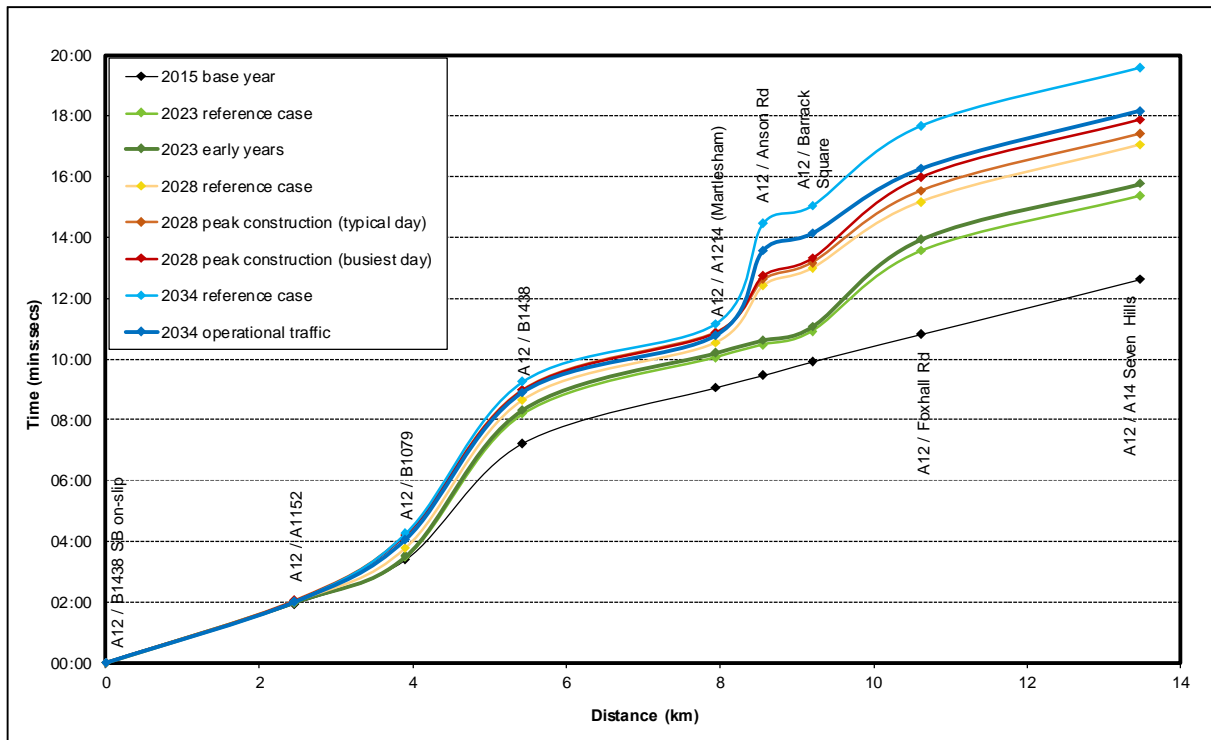
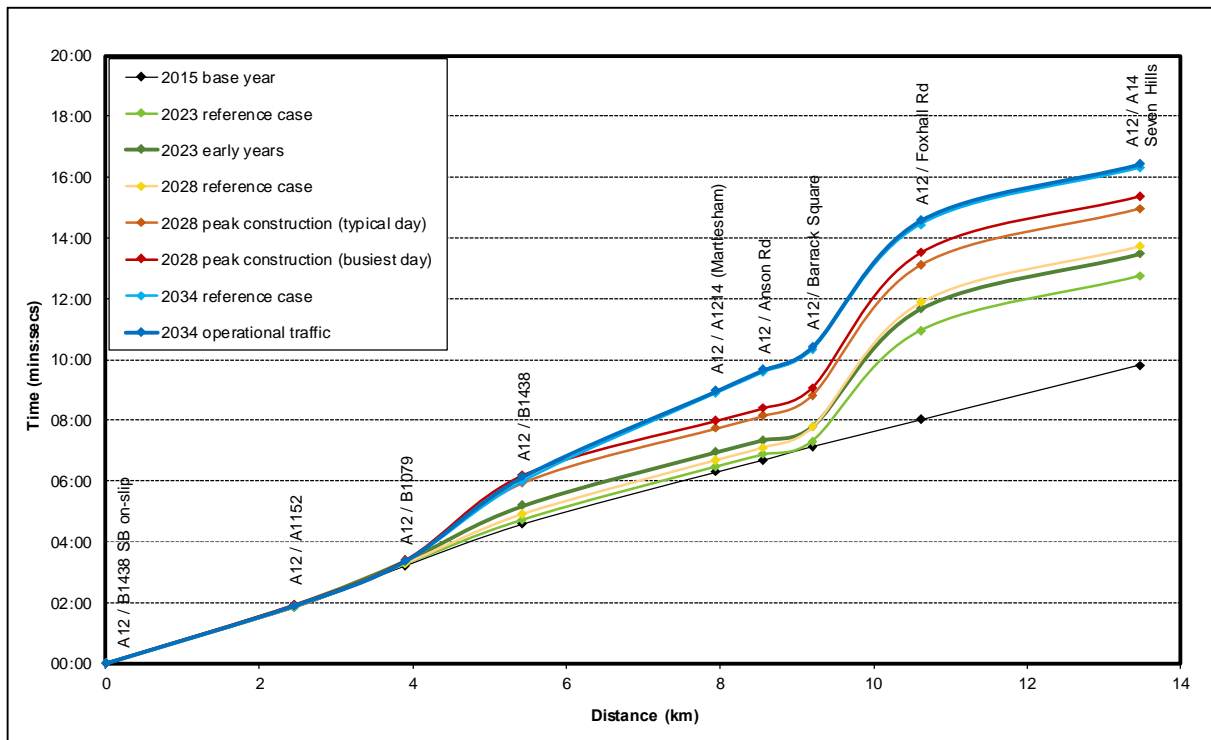

Figure 8E.68 – Route A5 Southbound – 17:00-18:00 hours



APPENDIX 8F

Sensitivity Test All HGVs from A12 South

TECHNICAL NOTE: SIZEWELL C VISUM TRAFFIC MODEL

DATE:	26 November 2020	CONFIDENTIALITY:	Public
SUBJECT:	Additional Information – Sensitivity test: 100% of HGVs from south		
PROJECT:	50400326	AUTHOR:	Sally Powell
CHECKED:	Nick Cottman	APPROVED:	Nick Cottman

1.0 INTRODUCTION

- 1.1. The geographical distribution of Sizewell C construction HGVs assumed in the **Transport Assessment** (Doc Ref. 8.5(A)) [AS-017], is:
 - 85% from the south (including Felixstowe, Ipswich and London/South of England); and
 - 15% from the north (including Lowestoft and Norwich).
- 1.2. Further work has been undertaken by SZC Co.'s supply chain partners, which has led to more certainty on the likely source of principal materials, although there remain choices to be made during the procurement negotiations. The further detail on likely material sources and mode share (i.e. road, rail, marine) is summarised in the **Freight Management Strategy** (Doc Ref 8.18).
- 1.3. As set out in the **Freight Management Strategy** (Doc Ref 8.18), it is not economic to load smaller or specialist materials onto rail or sea and these are therefore likely to arrive by road to the main development site. These types of materials include consumables, PPE fuels, oil, greases, timber, skips, lifting and construction equipment, small plant, general stores, and catering/food supplies. Based on the more detailed work, the HGV distribution assessed within the **Transport Assessment** (Doc Ref. 8.5(A)) [AS-017] is still considered to be reasonable and takes account of these smaller materials as well as locally supplied materials.
- 1.4. However, a sensitivity test has been undertaken based on 100% of HGVs from the A12 south in order to understand if an alternative HGV distribution would result in any changes to the effects summarised in the **Transport Assessment** (Doc Ref. 8.5(A)) [AS-017] or the ES assessment on transport (**Volume 2, Chapter 10** of the ES (Doc Ref. 6.3) [APP-198]), noise and vibration (**Volume 2, Chapter 11** of the ES (Doc Ref. 6.3) [APP-198]) or air quality (**Volume 2, Chapter 12** of the ES (Doc Ref. 6.3) [APP-198]).
- 1.5. The sensitivity test is based on the following HGV distribution:
 - 100% from the A12 south (including Felixstowe, Ipswich and London/South of England); and
 - 0% from the A12 north.
- 1.6. This document details the sensitivity test inputs and resultant daily traffic flows, in both early years and peak construction scenarios, in comparison with the core assessment presented in **Chapter 8** of this of this **Transport Assessment Addendum** (Doc Ref. 8.5(A)Ad).

2.0 SENSITIVITY TEST INPUTS

A) PEAK CONSTRUCTION

- 1.7. The Sizewell C HGV demand at peak construction assessed within the **Transport Assessment** (Doc Ref. 8.5(A)) [AS-017] is:
 - 650 daily two-way HGVs on a typical day; and
 - 1,000 daily two-way HGVs on the busiest day.
- 1.8. The arrival and departure profile of HGVs is described in **Appendix 7B** of the **Transport Assessment** (Doc Ref. 8.5(A)) [AS-017].

- 1.9. This sensitivity test assumes all HGVs would travel on the A12 south of the Sizewell link road, but the additional 15% of HGVs on this route would avoid the existing network peak hours of 08:00-09:00 and 17:00-18:00 hours.

B) EARLY YEARS

- 1.10. The Sizewell C HGV demand in early years assessed within the **Transport Assessment** (Doc Ref. 8.5(A)) [[AS-017](#)] is:
- 480 daily two-way HGVs at the main development site;
 - 466 daily two-way HGVs associated with the construction of the associated development sites; and
 - 120 daily two-way HGVs associated with the Sizewell B Relocated Facilities.
- 1.11. The arrival and departure profile of HGVs is described in **Appendix 7B** of the **Transport Assessment** (Doc Ref. 8.5(A)) [[AS-017](#)].
- 1.12. This sensitivity test assumes all HGVs would travel on the A12 south of the B1122 in the early years, but the additional 15% of HGVs on this route would avoid the existing network peak hours of 08:00-09:00 and 17:00-18:00 hours.

3.0 SENSITIVITY TEST OUTPUT

- 1.13. As set out in **section 2** it is intended that, if 100% of the project-related HGVs were to come from the south, the additional 15% of HGVs on the A12 south would be controlled through the **Construction Traffic Management Plan (CTMP)** (Doc Ref. 8.7) [[APP-608](#)] so that they would travel outside of the existing network peak hours of 08:00-09:00 and 17:00-18:00 hours, to avoid adding additional traffic demand along the A12 during the network peak hours to those assessed within the **Transport Assessment** (Doc Ref. 8.5(A)) [[AS-017](#)].
- 1.14. This being the case, the Sensitivity Test has been carried out to assess the impact on daily traffic volumes by applying a manual adjustment to the flows reported in **Chapter 8** of this **Transport Assessment Addendum** (Doc Ref. 8.5(A)Ad).

A) PEAK CONSTRUCTION

- 1.15. **Table 1** presents the 24-hour AAWT traffic flow (rounded to 50 vehicles), for the peak construction phase with 100% of project-related HGVs from the south.



Table 1 – 2028 peak construction (sensitivity test) – forecast daily (24-hour) AAWT traffic flows

LOCATION	2015 BASE YEAR.	2028 REFERENCE CASE.	2028 PEAK CONSTRUCTION.				2028 PEAK CONSTRUCTION 'CUMULATIVE'.				
			TYPICAL DAY.		BUSIEST DAY.		TYPICAL DAY.		BUSIEST DAY.		
			SZC TRAFFIC.	TOTAL TRAFFIC.	SZC TRAFFIC.	TOTAL TRAFFIC.	SCOTTISH POWER TRAFFIC.	TOTAL TRAFFIC.	SCOTTISH POWER TRAFFIC.	TOTAL TRAFFIC.	
B1122 east of Yoxford.	R	3,450	4,300	600	4,450	600	4,450	50	4,500	50	4,500
A14 south of Ipswich west of Seven Hills.	S	57,300	65,600	1,400	66,400 - 67,000	1,700	66,500 - 67,300	200	66,150 - 67,250	200	66,350 - 67,500
A14 east of Seven Hills.	T	44,350	50,850	200	50,950 - 51,050	250	50,950 - 51,100	50	50,950 - 51,100	50	51,000 - 51,150
A12 Wrentham.	V	9,800	10,200	1,200	11,300 - 11,400	1,200	11,300 - 11,400	150	11,400 - 11,550	150	11,350 - 11,550
A12 Blythburgh.	W	10,400	11,350	1,800	13,000 - 13,150	1,800	12,950 - 13,150	150	13,100 - 13,300	150	13,050 - 13,300
A12 north of proposed northern park and ride.	X	14,000	15,600	2,550	18,050 - 18,150	2,550	18,000 - 18,150	100	18,050 - 18,250	100	18,000 - 18,250
A12 south of proposed southern park and ride.	Z	24,550	27,500	2,650	29,650 - 30,150	3,000	29,850 - 30,500	350	29,750 - 30,500	350	29,850 - 30,850
A12 Woodbridge.	AA	36,300	39,450	2,400	40,300 - 41,850	2,700	40,250 - 42,150	300	39,900 - 42,150	300	39,750 - 42,450
A12 Marlesford.	AB	18,800	21,950	1,700	23,450 - 23,650	2,050	23,650 - 24,000	400	23,650 - 24,050	400	23,850 - 24,400
Two village bypass.	AE	0	0	1,700	22,550	2,050	22,800	400	22,750	400	22,950
Sizewell link road south of Theberton.	AF	0	0	2,250	8,550	2,600	8,850	250	8,800	250	9,050
Sizewell link road east of A12.	AG	0	0	1,300	2,450	1,650	2,800	100	1,400 - 2,550	100	1,750 - 2,850

- 1.16. Compared with the peak construction assessment presented in **Table 8.6** in **Chapter 8** of the **Transport Assessment Addendum** (Doc Ref. 8.5(A)Ad), there would be reductions in traffic on the A12 north of the B1122 as the Sizewell C HGVs would not be present on this route.
- 1.17. There would be increases in total traffic on the A12 south of the Sizewell link road, which would carry the additional 15% of HGVs removed from the A12 north.
- 1.18. There would be around 100 additional vehicles on a typical day, and 150 additional vehicles on the busiest day, on the A12 between Seven Hills and the Sizewell link road. This would be split with the majority on the A14 west of the Seven Hills interchange, and a small proportion to the east from Felixstowe Port, though the reference case traffic flows are much higher on the A14 than on the A12 so the relative increase is smaller.

B) EARLY YEARS

- 1.19. **Table 2** presents the 24-hour AAWT traffic flow (rounded to 50 vehicles), for the early years construction phase with 100% of project-related HGVs from the A12 south.

Table 2 – 2023 early years (sensitivity test) – forecast daily (24-hour) AAWT traffic flows

LOCATION		2015 BASE YEAR.	2023 REFERENCE CASE.	2023 EARLY YEARS.		2023 EARLY YEARS 'CUMULATIVE'.	
				SZC TRAFFIC.	TOTAL TRAFFIC.	SCOTTISH POWER TRAFFIC.	TOTAL TRAFFIC.
B1122 east of Yoxford.	R	3,450	4,150	1,100	5,250	100	5,350 - 5,400
A14 south of Ipswich west of Seven Hills.	S	57,300	62,200	1,200	62,650 - 63,400	200	62,550 - 63,600
A14 east of Seven Hills.	T	44,350	49,100	250	49,300 - 49,350	50	49,250 - 49,400
A12 Wrentham.	V	9,800	9,600	550	10,150	150	10,200 - 10,300
A12 Blythburgh.	W	10,400	10,950	800	11,650 - 11,750	150	11,750 - 11,900
A12 north of proposed northern park and ride.	X	14,000	15,050	550	15,400 - 15,600	50	15,400 - 15,650
A12 south of proposed southern park and ride.	Z	24,550	26,250	2,000	27,750 - 28,250	350	27,800 - 28,550
A12 Woodbridge.	AA	36,300	38,500	1,800	39,050 - 40,300	300	38,700 - 40,600
A12 Marlesford.	AB	18,800	20,900	2,100	22,750 - 23,000	400	23,000 - 23,400
Two village bypass.	AE	0	0	0	0	0	0
Sizewell link road south of Theberton.	AF	0	0	0	0	0	0
Sizewell link road east of A12.	AG	0	0	0	0	0	0

- 1.20. The sensitivity test in the early years shows that there would be around 100 to 150 additional vehicles per day on the A12 between Seven Hills and the B1122, with an equivalent reduction north of this location. The traffic flows would vary on different stretches of the A12 due to the more widespread distribution of Sizewell C construction sites in the early years, which comprises the main development site and the associated development sites.

4.0 CONCLUSIONS

- 1.21. It is considered that, in operational terms, the additional HGVs from the south would not cause road capacity to be exceeded on any of the affected roads, though it is noted that the A12 at Woodbridge is already congested in the base year and will worsen in future years, without Sizewell C.
- 1.22. A sensitivity test of the 100% HGVs from the A12 south has been undertaken using the VISSIM microsimulation model of the A12 corridor between the Seven Hills junction and Woodbridge and is summarised in **Appendix 9C** of **Chapter 9** of this **Transport Assessment Addendum** (Doc Ref. 8.5(A)Ad).
- 1.23. Impacts on noise and vibration, air quality and transport effects of this sensitivity test are discussed in **Volume 1, Chapter 3** of the **ES Addendum** (Doc Ref. 6.14).

APPENDIX 9A

Junction Model Results Summary

Maximum Ratio of Flow to Capacity (RFC) by hour and forecast scenario for each junction	Thresholds	Red	Amber	Green	Note LInS junctions have an amber range of 90-100%
		>= 1.00	< 1.00	< 0.85	

Junction Name Sheet Streams Package	1 A140 / B1078	Base	2023		2028		2034		Difference		
			RC	EY	RC	PC	RC	OP	2023	2028	2034
			EY-RC	PC-RC	OP-RC						
	06:00-07:00	0.16	0.19	0.19	0.20	0.28	0.23	0.23	0.00	0.08	0.00
	07:00-08:00	0.35	0.40	0.43	0.48	0.51	0.51	0.51	0.03	0.03	0.00
	08:00-09:00	0.63	0.79	0.81	0.91	0.90	0.97	0.98	0.02	-0.01	0.01
	15:00-16:00	0.41	0.54	0.58	0.62	0.65	0.78	0.74	0.04	0.03	-0.04
	17:00-18:00	0.47	0.60	0.60	0.68	0.72	0.85	0.85	0.00	0.04	0.00

Junction Name Sheet Streams Package	2 B1078 / B1079	Base	2023		2028		2034		Difference		
			RC	EY	RC	PC	RC	OP	2023	2028	2034
			EY-RC	PC-RC	OP-RC						
	06:00-07:00	0.12	0.14	0.16	0.15	0.27	0.16	0.16	0.02	0.12	0.00
	07:00-08:00	0.39	0.43	0.47	0.48	0.59	0.60	0.59	0.04	0.11	-0.01
	08:00-09:00	0.62	0.77	0.80	0.87	0.96	1.16	1.16	0.03	0.09	0.00
	15:00-16:00	0.49	0.73	0.78	0.79	0.85	0.93	0.93	0.05	0.06	0.00
	17:00-18:00	0.55	0.72	0.74	0.82	0.87	0.98	0.98	0.02	0.05	0.00

Junction Name Sheet Streams Package	3 B1078 / B1116	Base	2023		2028		2034		Difference		
			RC	EY	RC	PC	RC	OP	2023	2028	2034
			EY-RC	PC-RC	OP-RC						
	06:00-07:00	0.13	0.14	0.15	0.14	0.29	0.15	0.15	0.01	0.15	0.00
	07:00-08:00	0.37	0.39	0.43	0.40	0.47	0.42	0.42	0.04	0.07	0.00
	08:00-09:00	0.61	0.64	0.65	0.66	0.68	0.70	0.71	0.01	0.02	0.01
	15:00-16:00	0.37	0.42	0.42	0.43	0.47	0.46	0.47	0.00	0.04	0.01
	17:00-18:00	0.37	0.41	0.47	0.43	0.45	0.49	0.49	0.06	0.02	0.00

Junction Name Sheet Streams Package	4a B1069 / B1078 (Woodbridge Rd)	Base	2023		2028		2034		Difference		
			RC	EY	RC	PC	RC	OP	2023	2028	2034
			EY-RC	PC-RC	OP-RC						
	06:00-07:00	0.03	0.04	0.04	0.05	0.04	0.04	0.04	0.00	-0.01	0.00
	07:00-08:00	0.08	0.10	0.10	0.11	0.12	0.11	0.12	0.00	0.01	0.01
	08:00-09:00	0.12	0.13	0.13	0.14	0.14	0.19	0.21	0.00	0.00	0.02
	15:00-16:00	0.12	0.15	0.15	0.17	0.16	0.22	0.22	0.00	-0.01	0.00
	17:00-18:00	0.11	0.12	0.13	0.13	0.13	0.20	0.20	0.01	0.00	0.00

Junction Name Sheet Streams Package	4b B1069 / B1078 (Snape Rd)	Base	2023		2028		2034		Difference		
			RC	EY	RC	PC	RC	OP	2023	2028	2034
			EY-RC	PC-RC	OP-RC						
	06:00-07:00	0.12	0.15	0.16	0.16	0.17	0.18	0.17	0.01	0.01	-0.01
	07:00-08:00	0.34	0.39	0.41	0.40	0.44	0.46	0.47	0.02	0.04	0.01
	08:00-09:00	0.35	0.38	0.38	0.39	0.39	0.50	0.52	0.00	0.00	0.02
	15:00-16:00	0.40	0.43	0.43	0.46	0.54	0.56	0.55	0.00	0.08	-0.01
	17:00-18:00	0.39	0.44	0.53	0.47	0.62	0.59	0.59	0.09	0.15	0.00

Junction Name Sheet Streams Package	5 B1069 / A1094 (Snape Road, East)	Base	2023		2028		2034		Difference		
			RC	EY	RC	PC	RC	OP	2023	2028	2034
			EY-RC	PC-RC	OP-RC						
	06:00-07:00	0.28	0.37	0.40	0.38	0.41	0.39	0.38	0.03	0.03	-0.01
	07:00-08:00	0.60	0.78	0.87	0.81	0.86	0.78	0.78	0.09	0.05	0.00
	08:00-09:00	0.54	0.65	0.68	0.66	0.68	0.62	0.65	0.03	0.02	0.03
	15:00-16:00	0.58	0.70	0.74	0.75	0.86	0.79	0.78	0.04	0.11	-0.01
	17:00-18:00	0.44	0.83	0.98	0.81	0.99	0.59	0.58	0.15	0.18	-0.01

Junction Name Sheet Streams Package	5_miti B1069 / A1094 (Snape Road, East) - Mitigation Model	Base	2023		2028		2034		Difference		
			RC	EY	RC	PC	RC	OP	2023	2028	2034
			EY-RC	PC-RC	OP-RC						
	06:00-07:00	0.00	0.36	0.39	0.37	0.40	0.38	0.37	0.03	0.03	-0.01
	07:00-08:00	0.00	0.76	0.84	0.79	0.83	0.76	0.76	0.08	0.04	0.00
	08:00-09:00	0.00	0.63	0.66	0.65	0.66	0.61	0.63	0.03	0.01	0.02
	15:00-16:00	0.00	0.68	0.72	0.73	0.84	0.77	0.76	0.04	0.11	-0.01
	17:00-18:00	0.00	0.81	0.96	0.79	0.96	0.58	0.57	0.15	0.17	-0.01

Excludes Scottish Power Flows

Junction Name Sheet Streams Package	5_miti_nospr B1069 / A1094 (Snape Road, East) - Mitigation Model	Base	2023		2028		2034		Difference		
			RC	EY	RC	PC	RC	OP	2023	2028	2034
			EY-RC	PC-RC	OP-RC						
	06:00-07:00	0.00	0.36	0.39	0.37	0.40	0.38	0.38	0.03	0.03	0.00
	07:00-08:00	0.00	0.70	0.80	0.73	0.77	0.76	0.77	0.10	0.04	0.01
	08:00-09:00	0.00	0.56	0.58	0.57	0.58	0.61	0.65	0.02	0.01	0.04
	15:00-16:00	0.00	0.62	0.66	0.67	0.78	0.77	0.77	0.04	0.11	0.00
	17:00-18:00	0.00	0.49	0.63	0.51	0.66	0.58	0.58	0.14	0.15	0.00

v17

Junction Name Sheet Streams Package	6_miti A12 / A1094 - Mitigation Model	Base	2023		2028		2034		Difference		
			RC	EY	RC	PC	RC	OP	2023	2028	2034
			EY-RC	PC-RC	OP-RC						
	06:00-07:00			0.41		0.26		0.24			
	07:00-08:00			0.86		0.54		0.54			
	08:00-09:00			0.84		0.67		0.67			
	15:00-16:00			0.80		0.71		0.70			
	17:00-18:00			0.84		0.68		0.67			

As per DCO Transport Assessment

Junction Name Sheet Streams Package	7(N)a A12 / B1119	Base	2023		2028		2034		Difference		
			RC	EY	RC	PC	RC	OP	2023	2028	2034
			EY-RC	PC-RC	OP-RC						
	06:00-07:00	0.02	0.06	0.07	0.06	0.06	0.06	0.06	0.01	0.00	0.00
	07:00-08:00	0.12	0.15	0.19	0.15	0.16	0.16	0.16	0.04	0.01	0.00
	08:00-09:00	0.20	0.25	0.27	0.26	0.28	0.28	0.28	0.02	0.02	0.00
	15:00-16:00	0.19	0.25	0.26	0.25	0.26	0.28	0.28	0.01	0.01	0.00
	17:00-18:00	0.20	0.24	0.26	0.25	0.27	0.29	0.29	0.02	0.02	0.00

As per DCO Transport Assessment

Junction Name Sheet Streams Package	7(N)a_miti A12 / B1119 - Mitigation Model	Base	2023		2028		2034		Difference		
			RC	EY	RC	PC	RC	OP	2023	2028	2034
			EY-RC	PC-RC	OP-RC						
	06:00-07:00	0.00	0.06	0.07	0.06	0.06	0.06	0.06	0.01	0.00	0.00
	07:00-08:00	0.00	0.14	0.18	0.15	0.16	0.16	0.16	0.04	0.01	0.00
	08:00-09:00	0.00	0.24	0.26	0.25	0.27	0.27	0.27	0.02	0.02	0.00
	15:00-16:00	0.00	0.24	0.25	0.24	0.24	0.27	0.27	0.01	0.00	0.00
	17:00-18:00	0.00	0.23	0.25	0.25	0.26	0.28	0.28	0.02	0.01	0.00

As per DCO Transport Assessment

Junction Name Sheet Streams Package	7(N)b A12 / B1119	Base	2023		2028		2034		Difference		
			RC	EY	RC	PC	RC	OP	2023	2028	2034
			EY-RC	PC-RC	OP-RC						
	06:00-07:00	0.03	0.04	0.04	0.04	0.04	0.04	0.04	0.00	0.00	0.00
	07:00-08:00	0.09	0.11	0.11	0.12	0.12	0.13	0.13	0.00	0.00	0.00
	08:00-09:00	0.12	0.18	0.19	0.19	0.18	0.23	0.22	0.01	-0.01	-0.01
	15:00-16:00	0.12	0.15	0.15	0.16	0.16	0.17	0.16	0.00	0.00	-0.01
	17:00-18:00	0.16	0.25	0.30	0.28	0.28	0.33	0.32	0.05	0.00	-0.01

Maximum Ratio of Flow to Capacity (RFC) by hour and forecast scenario for each junction	Thresholds	Red	Amber	Green	Note LinSig junctions have an amber range of 90-100%
		>= 1.00	< 1.00	< 0.85	

Proposed P&R access only exists in 2028 PC

Junction 15_miti
Name Park and Ride (Wickham Market) - Mitigation Model
Sheet J15_miti
Streams 3
Package Junctions 9

	Base	2023		2028		2034	
		RC	EY	RC	PC	RC	OP
06:00-07:00					0.02		
07:00-08:00					0.07		
08:00-09:00					0.09		
15:00-16:00					0.25		
17:00-18:00					0.16		

Difference		
2023	2028	2034
EY-RC	PC-RC	OP-RC

Proposed P&R access only exists in 2028 PC

Junction 17_miti
Name Park and Ride (Darsham) - Mitigation Model
Sheet J17_miti
Streams 3
Package Junctions 9

	Base	2023		2028		2034	
		RC	EY	RC	PC	RC	OP
06:00-07:00					0.63		
07:00-08:00					0.73		
08:00-09:00					0.60		
15:00-16:00					0.68		
17:00-18:00					0.69		

2023	2028	2034
EY-RC	PC-RC	OP-RC

Existing layout, uses demand flows that include fuel & income adjustment

Junction 21
Name A12 / A14 / A1156 Seven Hills Interchange
Sheet J21
Streams 5
Package Junctions 9

	Base	2023		2028		2034	
		RC	EY	RC	PC	RC	OP
06:00-07:00	0.35	0.37	0.37				
07:00-08:00	0.65	0.68	0.71				
08:00-09:00	0.86	0.92	0.98				
15:00-16:00	0.66	0.70	0.72				
17:00-18:00	0.70	0.77	0.83				

2023	2028	2034
EY-RC	PC-RC	OP-RC
0.00	0.00	0.00
0.03	0.00	0.00
0.06	0.00	0.00
0.02	0.00	0.00
0.06	0.00	0.00

Existing layout, uses actual flows that exclude fuel & income adjustment

Junction 21_sens
Name A12 / A14 / A1156 Seven Hills Interchange
Sheet J21_sens
Streams 5
Package Junctions 9

	Base	2023		2028		2034	
		RC	EY	RC	PC	RC	OP
06:00-07:00	0.35	0.36	0.37				
07:00-08:00	0.65	0.67	0.68				
08:00-09:00	0.86	0.86	0.89				
15:00-16:00	0.66	0.67	0.68				
17:00-18:00	0.70	0.74	0.75				

2023	2028	2034
EY-RC	PC-RC	OP-RC
0.01	0.00	0.00
0.01	0.00	0.00
0.03	0.00	0.00
0.01	0.00	0.00
0.01	0.00	0.00

Upgraded layout, uses demand flows that include fuel & income adjustment

Junction 21_miti
Name A12 / A14 / A1156 Seven Hills Interchange - Mitigation Model
Sheet J21_miti
Streams 5
Package LinSig

	Base	2023		2028		2034	
		RC	EY	RC	PC	RC	OP
06:00-07:00				53%	57%	55%	55%
07:00-08:00				136%	156%	139%	114%
08:00-09:00				120%	125%	131%	125%
15:00-16:00				92%	117%	127%	127%
17:00-18:00				95%	95%	116%	128%

2023	2028	2034
EY-RC	PC-RC	OP-RC
0%	4%	0%
0%	20%	-25%
0%	6%	-7%
0%	25%	0%
0%	0%	12%

Upgraded layout, uses actual flows that exclude fuel & income adjustment

Junction 21_miti_sens
Name A12 / A14 / A1156 Seven Hills Interchange - Mitigation Model
Sheet J21_miti_sens
Streams 5
Package VISSIM / LinSig

	Base	2023		2028		2034	
		RC	EY	RC	PC	RC	OP
06:00-07:00				50%	54%	53%	53%
07:00-08:00				120%	102%	105%	122%
08:00-09:00				130%	119%	117%	118%
15:00-16:00				90%	90%	90%	90%
17:00-18:00				88%	88%	91%	91%

2023	2028	2034
EY-RC	PC-RC	OP-RC
0%	4%	0%
0%	-18%	17%
0%	-11%	1%
0%	1%	0%
0%	0%	0%

Existing layout, uses demand flows that include fuel & income adjustment

Junction 22
Name A12 / Foxhall Road / Newbourne Road
Sheet J22
Streams 4
Package Junctions 9

	Base	2023		2028		2034	
		RC	EY	RC	PC	RC	OP
06:00-07:00	0.34	0.36	0.37	0.37	0.37	0.39	0.39
07:00-08:00	0.69	0.82	1.02	0.98	1.16	1.16	1.15
08:00-09:00	1.43	1.84	2.09	2.19	2.17	2.23	2.21
15:00-16:00	0.75	0.81	0.82	1.01	1.04	1.42	1.41
17:00-18:00	0.81	0.83	0.84	0.92	0.92	1.12	1.12

2023	2028	2034
EY-RC	PC-RC	OP-RC
0.01	0.00	0.00
0.20	0.18	-0.01
0.25	-0.02	-0.02
0.01	0.03	-0.01
0.01	0.00	0.00

Existing layout, uses actual flows that exclude fuel & income adjustment

Junction 22_sens
Name A12 / Foxhall Road / Newbourne Road
Sheet J22_sens
Streams 4
Package VISSIM / Junctions 9

	Base	2023		2028		2034	
		RC	EY	RC	PC	RC	OP
06:00-07:00	0.34	0.36	0.36				
07:00-08:00	0.69	0.79	0.96				
08:00-09:00	1.43	1.69	1.95				
15:00-16:00	0.75	0.79	0.80				
17:00-18:00	0.81	0.81	0.82				

2023	2028	2034
EY-RC	PC-RC	OP-RC
0.00		
0.17		
0.26		
0.01		
0.01		

Upgraded layout, uses demand flows that include fuel & income adjustment

Junction 22_miti
Name A12 / Foxhall Road / Newbourne Road - Mitigation Model
Sheet J22_miti
Streams 4
Package LinSig

	Base	2023		2028		2034	
		RC	EY	RC	PC	RC	OP
06:00-07:00				34%	35%	35%	35%
07:00-08:00				88%	94%	86%	92%
08:00-09:00				118%	113%	127%	121%
15:00-16:00				85%	86%	103%	100%
17:00-18:00				94%	97%	127%	118%

2023	2028	2034
EY-RC	PC-RC	OP-RC
	2%	0%
	6%	6%
	-5%	-6%
	1%	-3%
	3%	-9%

Upgraded layout, uses actual flows that exclude fuel & income adjustment

Junction 22_miti_sens
Name A12 / Foxhall Road / Newbourne Road - Mitigation Model
Sheet J22_miti_sens
Streams 4
Package VISSIM / LinSig

	Base	2023		2028		2034	
		RC	EY	RC	PC	RC	OP
06:00-07:00				33%	35%	34%	34%
07:00-08:00				78%	84%	88%	91%
08:00-09:00				111%	109%	118%	106%
15:00-16:00				84%	88%	87%	87%
17:00-18:00				88%	88%	100%	100%

2023	2028	2034
EY-RC	PC-RC	OP-RC
	2%	0%
	6%	3%
	-2%	-12%
	5%	0%
	0%	0%

Upgraded layout, uses demand flows that include fuel & income adjustment

Junction 22b_miti
Name Brightwell Lakes Access / A12
Sheet J22b_miti
Streams 3
Package LinSig

	Base	2023		2028		2034	
		RC	EY	RC	PC	RC	OP
06:00-07:00		42%	42%	41%	42%	43%	43%
07:00-08:00		77%	82%	82%	86%	87%	87%
08:00-09:00		100%	102%	104%	103%	106%	102%
15:00-16:00		100%	85%	90%	92%	130%	130%
17:00-18:00		84%	83%	118%	118%	166%	166%

2023	2028	2034
EY-RC	PC-RC	OP-RC
1%	0%	0%
5%	4%	0%
2%	-1%	-4%
-14%	1%	0%
-1%	0%	0%

Upgraded layout, uses actual flows that exclude fuel & income adjustment

Junction 22b_miti_sens
Name Brightwell Lakes Access / A12
Sheet J22b_miti_sens
Streams 3
Package VISSIM / LinSig

	Base	2023		2028		2034	
		RC	EY	RC	PC	RC	OP
06:00-07:00		42%	42%	42%	42%	43%	43%
07:00-08:00		73%	73%	74%	74%	76%	77%
08:00-09:00		95%	95%	95%	95%	96%	92%
15:00-16:00		83%	83%	88%	87%	92%	92%
17:00-18:00		84%	83%	89%	86%	92%	92%

2023	2028	2034
EY-RC	PC-RC	OP-RC
1%	0%	0%
0%	0%	1%
0%	0%	-4%
-1%	-1%	0%
-1%	-2%	0%

Maximum Ratio of Flow to Capacity (RFC) by hour and forecast scenario for each junction		Thresholds		Red >= 1.00		Amber < 1.00		Green < 0.85		Note LInSg junctions have an amber range of 90-100% Difference		
Junction Name	35c B1121 Main Road / Slip Road	Base		2023		2028		2034		2023	2028	2034
Sheet	J35c		RC	EY	RC	PC	RC	OP	EY-RC	PC-RC	OP-RC	
Streams	2	06:00-07:00	0.00	0.00	0.00	0.00	0.01	0.01	0.00	0.01	0.00	
Package	Junctions 9	07:00-08:00	0.03	0.05	0.06	0.09	0.09	0.13	0.01	0.00	0.00	
		08:00-09:00	0.06	0.10	0.11	0.16	0.17	0.20	0.01	0.01	0.01	
		15:00-16:00	0.06	0.10	0.10	0.13	0.14	0.18	0.00	0.01	-0.01	
		17:00-18:00	0.02	0.05	0.05	0.11	0.11	0.16	0.00	0.00	0.00	
Junction Name	36a A12 / Main Road	Base		2023		2028		2034		2023	2028	2034
Sheet	J36a		RC	EY	RC	PC	RC	OP	EY-RC	PC-RC	OP-RC	
Streams	3	06:00-07:00	0.04	0.04	0.05	0.05	0.06	0.05	0.01	0.01	-0.01	
Package	Junctions 9	07:00-08:00	0.12	0.12	0.21	0.13	0.15	0.14	0.09	0.02	-0.01	
		08:00-09:00	0.20	0.20	0.23	0.22	0.22	0.24	0.03	0.00	0.06	
		15:00-16:00	0.22	0.24	0.24	0.25	0.26	0.26	0.00	0.01	-0.01	
		17:00-18:00	0.19	0.21	0.23	0.21	0.22	0.20	0.02	0.01	-0.03	
As per DCO Transport Assessment												
Junction Name	36b A12 Slip / Main Road	Base		2023		2028		2034		2023	2028	2034
Sheet	J36b		RC	EY	RC	PC	RC	OP	EY-RC	PC-RC	OP-RC	
Streams	2	06:00-07:00	0.02	0.02	0.02	0.03	0.03	0.03	0.00	0.00	0.00	
Package	Junctions 9	07:00-08:00	0.08	0.08	0.09	0.09	0.09	0.10	0.01	0.00	-0.01	
		08:00-09:00	0.16	0.16	0.19	0.17	0.19	0.18	0.03	0.02	0.00	
		15:00-16:00	0.13	0.14	0.14	0.15	0.15	0.16	0.00	0.00	-0.01	
		17:00-18:00	0.13	0.14	0.17	0.15	0.15	0.15	0.03	0.00	-0.01	
Junction Name	37 A12 / B1387	Base		2023		2028		2034		2023	2028	2034
Sheet	J37		RC	EY	RC	PC	RC	OP	EY-RC	PC-RC	OP-RC	
Streams	3	06:00-07:00	0.03	0.03	0.03	0.03	0.03	0.03	0.00	0.00	-0.01	
Package	Junctions 9	07:00-08:00	0.05	0.06	0.07	0.06	0.06	0.06	0.01	0.00	0.00	
		08:00-09:00	0.05	0.06	0.06	0.06	0.06	0.07	0.00	0.00	-0.01	
		15:00-16:00	0.07	0.08	0.08	0.08	0.09	0.09	0.00	0.01	0.00	
		17:00-18:00	0.07	0.07	0.08	0.08	0.08	0.09	0.01	0.00	0.00	
Junction Name	38 A12 / B1125 Angel Lane	Base		2023		2028		2034		2023	2028	2034
Sheet	J38		RC	EY	RC	PC	RC	OP	EY-RC	PC-RC	OP-RC	
Streams	2	06:00-07:00	0.07	0.09	0.13	0.09	0.11	0.09	0.04	0.02	0.00	
Package	Junctions 9	07:00-08:00	0.20	0.24	0.42	0.26	0.32	0.27	0.18	0.06	0.00	
		08:00-09:00	0.32	0.33	0.38	0.35	0.37	0.38	0.05	0.02	0.00	
		15:00-16:00	0.46	0.49	0.55	0.50	0.61	0.56	0.06	0.11	0.00	
		17:00-18:00	0.30	0.43	0.71	0.44	0.48	0.26	0.28	0.04	0.00	
Junction Name	39 A12 / Marlesford Road	Base		2023		2028		2034		2023	2028	2034
Sheet	J39		RC	EY	RC	PC	RC	OP	EY-RC	PC-RC	OP-RC	
Streams	3	06:00-07:00	0.00	0.00	0.00	0.00	0.00	0.00	0.00	0.00	0.00	
Package	Junctions 9	07:00-08:00	0.03	0.04	0.06	0.04	0.05	0.04	0.02	0.01	0.01	
		08:00-09:00	0.00	0.01	0.01	0.01	0.01	0.01	0.00	0.00	0.00	
		15:00-16:00	0.02	0.02	0.02	0.02	0.03	0.03	0.00	0.01	0.00	
		17:00-18:00	0.02	0.02	0.02	0.02	0.03	0.03	0.00	0.01	0.00	
Junction Name	40 A12 / Bell Lane	Base		2023		2028		2034		2023	2028	2034
Sheet	J40		RC	EY	RC	PC	RC	OP	EY-RC	PC-RC	OP-RC	
Streams	3	06:00-07:00	0.05	0.06	0.06	0.06	0.06	0.06	0.00	0.00	0.00	
Package	Junctions 9	07:00-08:00	0.18	0.23	0.45	0.27	0.35	0.29	0.22	0.08	0.02	
		08:00-09:00	0.28	0.38	0.51	0.46	0.63	0.41	0.13	0.17	0.01	
		15:00-16:00	0.16	0.21	0.25	0.25	0.38	0.31	0.04	0.13	0.00	
		17:00-18:00	0.13	0.18	0.26	0.21	0.29	0.22	0.08	0.08	0.01	
Junction Name	41 A1156 / Felixstowe Road	Base		2023		2028		2034		2023	2028	2034
Sheet	J41		RC	EY	RC	PC	RC	OP	EY-RC	PC-RC	OP-RC	
Streams	3	06:00-07:00	0.07	0.08	0.08	0.08	0.08	0.08	0.00	0.00	0.00	
Package	Junctions 9	07:00-08:00	0.19	0.21	0.21	0.23	0.23	0.24	0.00	0.00	0.00	
		08:00-09:00	0.21	0.24	0.24	0.27	0.26	0.30	0.00	-0.01	0.00	
		15:00-16:00	0.20	0.24	0.24	0.27	0.27	0.35	0.00	0.00	0.00	
		17:00-18:00	0.28	0.35	0.36	0.40	0.40	0.48	0.01	0.00	-0.01	
Junction Name	42_miti A12 / Sizewell Link Road	Base		2023		2028		2034		2023	2028	2034
Sheet	J42_miti		RC	EY	RC	PC	RC	OP	EY-RC	PC-RC	OP-RC	
Streams	3	06:00-07:00				0.26		0.22				
Package	Junctions 9	07:00-08:00				0.56		0.46				
		08:00-09:00				0.55		0.53				
		15:00-16:00				0.63		0.57				
		17:00-18:00				0.56		0.52				
Junction Name	43_miti B1122 / Site Access	Base		2023		2028		2034		2023	2028	2034
Sheet	J43_miti		RC	EY	RC	PC	RC	OP	EY-RC	PC-RC	OP-RC	
Streams	5	06:00-07:00		0.28		0.30		0.19				
Package	Junctions 9	07:00-08:00		0.58		0.55		0.38				
		08:00-09:00		0.42		0.46		0.53				
		15:00-16:00		0.16		0.22		0.13				
		17:00-18:00		0.38		0.33		0.31				
Junction Name	44_miti B1122 / Lover's Lane	Base		2023		2028		2034		2023	2028	2034
Sheet	J44_miti		RC	EY	RC	PC	RC	OP	EY-RC	PC-RC	OP-RC	
Streams	3	06:00-07:00		0.06	0.09	0.06	0.09	0.06	0.03	0.03	0.01	
Package	Junctions 9	07:00-08:00		0.14	0.25	0.14	0.27	0.11	0.11	0.13	0.04	
		08:00-09:00		0.08	0.16	0.08	0.11	0.08	0.08	0.03	0.10	
		15:00-16:00		0.22	0.39	0.23	0.30	0.23	0.17	0.07	0.02	
		17:00-18:00		0.23	0.56	0.21	0.36	0.15	0.33	0.15	0.03	
Junction Name	45_miti A12 / Tinker Brook	Base		2023		2028		2034		2023	2028	2034
Sheet	J45_miti		RC	EY	RC	PC	RC	OP	EY-RC	PC-RC	OP-RC	
Streams	4	06:00-07:00				0.40		0.40				
Package	Junctions 9	07:00-08:00				0.69		0.69				
		08:00-09:00				0.70		0.68				
		15:00-16:00				0.72		0.70				
		17:00-18:00				0.62		0.59				

Maximum Delay (in seconds) by hour and forecast scenario for each junction	Thresholds	Red	Amber	Green	Difference
		>= 30	< 30	< 20	

Junction Name Sheet Streams Package	1 A140 / B1078 J1 4 Junctions 9	Base	2023			2028		2034		2023 EY-RC	2028 PC-RC	2034 OP-RC
			RC	EY	RC	PC	RC	OP				
			06:00-07:00	8	8	8	8	9	8			
07:00-08:00	11	12	13	14	15	15	15	1	1	0		
08:00-09:00	21	35	38	68	64	103	110	3	-4	7		
15:00-16:00	12	15	17	19	21	34	29	2	2	-5		
17:00-18:00	13	17	18	22	25	46	46	0	3	0		

Junction Name Sheet Streams Package	2 B1078 / B1079 J2 2 Junctions 9	Base	2023			2028		2034		2023 EY-RC	2028 PC-RC	2034 OP-RC
			RC	EY	RC	PC	RC	OP				
			06:00-07:00	7	7	7	7	8	7			
07:00-08:00	11	12	13	13	16	17	16	1	4	-1		
08:00-09:00	19	31	35	50	92	301	312	4	42	11		
15:00-16:00	12	24	29	31	42	70	71	5	11	1		
17:00-18:00	14	23	25	34	45	100	99	2	11	-1		

Junction Name Sheet Streams Package	3 B1078 / B1116 J3 4 Junctions 9	Base	2023			2028		2034		2023 EY-RC	2028 PC-RC	2034 OP-RC
			RC	EY	RC	PC	RC	OP				
			06:00-07:00	5	5	5	5	6	5			
07:00-08:00	7	7	8	7	9	8	8	1	2	0		
08:00-09:00	12	13	14	14	15	16	16	1	1	0		
15:00-16:00	8	9	9	9	10	10	10	0	1	0		
17:00-18:00	8	8	9	9	9	10	10	0	0	0		

Junction Name Sheet Streams Package	4a B1069 / B1078 (Woodbridge Rd) J4a 2 Junctions 9	Base	2023			2028		2034		2023 EY-RC	2028 PC-RC	2034 OP-RC
			RC	EY	RC	PC	RC	OP				
			06:00-07:00	6	6	6	6	6	6			
07:00-08:00	7	7	7	7	7	7	7	0	0	0		
08:00-09:00	7	7	8	8	8	8	9	0	0	0		
15:00-16:00	7	7	7	8	8	9	9	0	0	0		
17:00-18:00	7	7	7	7	7	8	8	0	0	0		

Junction Name Sheet Streams Package	4b B1069 / B1078 (Snape Rd) J4b 2 Junctions 9	Base	2023			2028		2034		2023 EY-RC	2028 PC-RC	2034 OP-RC
			RC	EY	RC	PC	RC	OP				
			06:00-07:00	12	12	12	12	12	12			
07:00-08:00	16	17	18	17	19	19	20	1	1	1		
08:00-09:00	17	18	18	18	18	22	23	0	0	1		
15:00-16:00	19	20	20	21	24	26	25	0	3	0		
17:00-18:00	19	21	24	22	30	29	28	4	8	0		

Junction Name Sheet Streams Package	5 B1069 / A1094 (Snape Road, East) J5 2 Junctions 9	Base	2023			2028		2034		2023 EY-RC	2028 PC-RC	2034 OP-RC
			RC	EY	RC	PC	RC	OP				
			06:00-07:00	12	12	13	12	13	12			
07:00-08:00	20	37	57	42	54	37	37	20	12	0		
08:00-09:00	18	25	28	27	28	23	24	3	1	2		
15:00-16:00	21	31	36	38	60	42	39	5	22	-3		
17:00-18:00	14	46	112	42	116	21	20	66	74	-1		

Junction Name Sheet Streams Package	5_miti B1069 / A1094 (Snape Road, East) - Mitigation Model J5_miti 2 Junctions 9	Base	2023			2028		2034		2023 EY-RC	2028 PC-RC	2034 OP-RC
			RC	EY	RC	PC	RC	OP				
			06:00-07:00	0	12	12	12	12	12			
07:00-08:00	0	33	49	37	47	33	33	16	10	0		
08:00-09:00	0	23	26	25	26	21	22	2	1	1		
15:00-16:00	0	29	33	34	52	37	35	4	18	-2		
17:00-18:00	0	40	93	37	97	20	19	53	60	-1		

Excludes Scottish Power Flows

Junction Name Sheet Streams Package	5_miti_nospr B1069 / A1094 (Snape Road, East) - Mitigation Model J5_miti_nospr 2 Junctions 9	Base	2023			2028		2034		2023 EY-RC	2028 PC-RC	2034 OP-RC
			RC	EY	RC	PC	RC	OP				
			06:00-07:00	0	12	12	12	12	12			
07:00-08:00	0	26	38	28	35	33	35	12	6	2		
08:00-09:00	0	18	19	19	20	21	24	1	1	3		
15:00-16:00	0	23	26	27	38	37	38	3	11	0		
17:00-18:00	0	16	22	17	24	20	20	6	7	0		

Junction Name Sheet Streams Package	6_miti A12 / A1094 - Mitigation Model J6_miti 4 Junctions 9	Base	2023			2028		2034		2023 EY-RC	2028 PC-RC	2034 OP-RC
			RC	EY	RC	PC	RC	OP				
			06:00-07:00			5		4				
07:00-08:00			19		6		6					
08:00-09:00			21		7		7					
15:00-16:00			16		9		9					
17:00-18:00			17		9		7					

As per DCO Transport Assessment

Junction Name Sheet Streams Package	7(N)a A12 / B1119 J7(N)a 3 Junctions 9	Base	2023			2028		2034		2023 EY-RC	2028 PC-RC	2034 OP-RC
			RC	EY	RC	PC	RC	OP				
			06:00-07:00	8	8	8	7	7	7			
07:00-08:00	7	8	9	8	9	8	8	2	1	0		
08:00-09:00	8	9	11	10	11	11	11	1	1	0		
15:00-16:00	9	10	10	10	11	11	11	0	1	0		
17:00-18:00	8	9	10	9	10	10	10	1	1	0		

As per DCO Transport Assessment

Junction Name Sheet Streams Package	7(N)a_miti A12 / B1119 - Mitigation Model J7(N)a_miti 3 Junctions 9	Base	2023			2028		2034		2023 EY-RC	2028 PC-RC	2034 OP-RC
			RC	EY	RC	PC	RC	OP				
			06:00-07:00	0	8	8	7	7	7			
07:00-08:00	0	8	9	8	8	8	8	1	1	0		
08:00-09:00	0	9	10	9	10	10	10	1	1	0		
15:00-16:00	0	10	10	9	10	10	10	0	1	0		
17:00-18:00	0	9	10	9	10	10	10	1	1	0		

As per DCO Transport Assessment

Junction Name Sheet Streams Package	7(N)b A12 / B1119 J7(N)b 2 Junctions 9	Base	2023			2028		2034		2023 EY-RC	2028 PC-RC	2034 OP-RC
			RC	EY	RC	PC	RC	OP				
			06:00-07:00	5	5	5	5	5	5			
07:00-08:00	5	6	6	6	6	6	6	0	0	0		
08:00-09:00	6	6	6	6	6	7	6	0	0	0		
15:00-16:00	6	6	6	6	6	6	6	0	0	0		
17:00-18:00	6	7	7	7	7	7	7	0	0	0		

Maximum Delay (in seconds) by hour and forecast scenario for each junction	Thresholds	Red >= 30	Amber < 30	Green < 20	Difference
---	------------	--------------	---------------	---------------	------------

Proposed P&R access only exists in 2028 PC

Junction 15_miti
Name Park and Ride (Wickham Market) - Mitigation Model
Sheet J15_miti
Streams 3
Package Junctions 9

	Base	2023			2028		2034	
		RC	EY	RC	PC	RC	OP	
06:00-07:00					10			
07:00-08:00					13			
08:00-09:00					11			
15:00-16:00					12			
17:00-18:00					12			

2023	2028	2034
EY-RC	PC-RC	OP-RC

Proposed P&R access only exists in 2028 PC

Junction 17_miti
Name Park and Ride (Darsham) - Mitigation Model
Sheet J17_miti
Streams 3
Package Junctions 9

	Base	2023			2028		2034	
		RC	EY	RC	PC	RC	OP	
06:00-07:00					8			
07:00-08:00					11			
08:00-09:00					8			
15:00-16:00					9			
17:00-18:00					10			

2023	2028	2034
EY-RC	PC-RC	OP-RC

Existing layout, uses demand flows that include fuel & income adjustment

Junction 21
Name A12 / A14 / A1156 Seven Hills Interchange
Sheet J21
Streams 5
Package Junctions 9

	Base	2023			2028		2034	
		RC	EY	RC	PC	RC	OP	
06:00-07:00	4	4	4	4	5	4	4	
07:00-08:00	10	12	15	12	18	16	16	
08:00-09:00	32	50	78	142	221	296	336	
15:00-16:00	10	13	15	18	24	79	76	
17:00-18:00	12	16	22	24	29	169	174	

2023	2028	2034
EY-RC	PC-RC	OP-RC
0	1	0
2	6	0
29	79	40
2	6	-3
7	6	5

Existing layout, uses actual flows that exclude fuel & income adjustment

Junction 21_sens
Name A12 / A14 / A1156 Seven Hills Interchange
Sheet J21_sens
Streams 5
Package Junctions 9

	Base	2023			2028		2034	
		RC	EY	RC	PC	RC	OP	
06:00-07:00	4	4	4					
07:00-08:00	10	11	13					
08:00-09:00	32	33	39					
15:00-16:00	10	11	12					
17:00-18:00	12	14	15					

2023	2028	2034
EY-RC	PC-RC	OP-RC
0	0	0
1	0	0
7	0	0
1	0	0
1	0	0

Upgraded layout, uses demand flows that include fuel & income adjustment

Junction 21_miti
Name A12 / A14 / A1156 Seven Hills Interchange - Mitigation Model
Sheet J21_miti
Streams 5
Package LinSig

	Base	2023			2028		2034	
		RC	EY	RC	PC	RC	OP	
06:00-07:00				33	35	34	34	
07:00-08:00				546	721	574	286	
08:00-09:00				363	403	498	394	
15:00-16:00				62	327	444	445	
17:00-18:00				80	81	319	460	

2023	2028	2034
EY-RC	PC-RC	OP-RC
0	2	0
0	176	-288
0	40	-104
0	265	1
0	1	141

Upgraded layout, uses actual flows that exclude fuel & income adjustment

Junction 21_miti_sens
Name A12 / A14 / A1156 Seven Hills Interchange - Mitigation Model
Sheet J21_miti_sens
Streams 5
Package VISSIM / LinSig

	Base	2023			2028		2034	
		RC	EY	RC	PC	RC	OP	
06:00-07:00				31	35	33	33	
07:00-08:00				369	138	132	389	
08:00-09:00				485	319	330	337	
15:00-16:00				57	57	54	54	
17:00-18:00				53	53	57	57	

2023	2028	2034
EY-RC	PC-RC	OP-RC
0	3	0
0	-232	257
0	-165	7
0	1	0
0	0	0

Existing layout, uses demand flows that include fuel & income adjustment

Junction 22
Name A12 / Foxhall Road / Newbourne Road
Sheet J22
Streams 4
Package Junctions 9

	Base	2023			2028		2034	
		RC	EY	RC	PC	RC	OP	
06:00-07:00	4	4	4	4	4	4	4	
07:00-08:00	17	31	121	86	249	252	236	
08:00-09:00	513	933	1537	1710	1671	1819	1785	
15:00-16:00	17	25	28	109	134	532	521	
17:00-18:00	15	17	18	35	37	208	213	

2023	2028	2034
EY-RC	PC-RC	OP-RC
0	0	0
91	163	-16
-39	-34	
4	25	-11
1	2	5

Existing layout, uses actual flows that exclude fuel & income adjustment

Junction 22_sens
Name A12 / Foxhall Road / Newbourne Road
Sheet J22_sens
Streams 4
Package VISSIM / Junctions 9

	Base	2023			2028		2034	
		RC	EY	RC	PC	RC	OP	
06:00-07:00	4	4	4					
07:00-08:00	17	26	80					
08:00-09:00	513	763	1020					
15:00-16:00	17	19	22					
17:00-18:00	15	16	15					

2023	2028	2034
EY-RC	PC-RC	OP-RC
0		
54		
257		
3		
-1		

Upgraded layout, uses demand flows that include fuel & income adjustment

Junction 22_miti
Name A12 / Foxhall Road / Newbourne Road - Mitigation Model
Sheet J22_miti
Streams 4
Package LinSig

	Base	2023			2028		2034	
		RC	EY	RC	PC	RC	OP	
06:00-07:00				34	34	34	34	
07:00-08:00				64	92	54	75	
08:00-09:00				323	261	438	366	
15:00-16:00				42	41	101	67	
17:00-18:00				38	52	427	311	

2023	2028	2034
EY-RC	PC-RC	OP-RC
	0	0
	27	21
	-61	
	0	-35
	14	-115

Upgraded layout, uses actual flows that exclude fuel & income adjustment

Junction 22_miti_sens
Name A12 / Foxhall Road / Newbourne Road - Mitigation Model
Sheet J22_miti_sens
Streams 4
Package VISSIM / LinSig

	Base	2023			2028		2034	
		RC	EY	RC	PC	RC	OP	
06:00-07:00				34	34	34	34	
07:00-08:00				48	61	62	69	
08:00-09:00				230	207	324	164	
15:00-16:00				40	49	47	48	
17:00-18:00				35	35	84	83	

2023	2028	2034
EY-RC	PC-RC	OP-RC
	0	0
	13	7
	-23	-160
	9	0
	0	-1

Upgraded layout, uses demand flows that include fuel & income adjustment

Junction 22b_miti
Name Brightwell Lakes Access / A12
Sheet J22b_miti
Streams 3
Package LinSig

	Base	2023			2028		2034	
		RC	EY	RC	PC	RC	OP	
06:00-07:00		40	40	40	14	14	14	
07:00-08:00		35	35	33	33	35	35	
08:00-09:00		67	89	124	108	161	93	
15:00-16:00		67	35	33	33	116	116	
17:00-18:00		35	35	78	78	811	812	

2023	2028	2034
EY-RC	PC-RC	OP-RC
0	-27	0
0	0	0
22	-17	-68
-32	1	0
0	0	1

Upgraded layout, uses actual flows that exclude fuel & income adjustment

Junction 22b_miti_sens
Name Brightwell Lakes Access / A12
Sheet J22b_miti_sens
Streams 3
Package VISSIM / LinSig

	Base	2023			2028		2034	
		RC	EY	RC	PC	RC	OP	
06:00-07:00		40	40	40	40	40	40	
07:00-08:00		33	41	33	34	34	35	
08:00-09:00		43	43	51	50	85	31	
15:00-16:00		41	41	42	43	45	44	
17:00-18:00		41	41	40	43	42	42	

2023	2028	2034
EY-RC	PC-RC	OP-RC
0	0	0
8	1	0
0	-1	-53
0	2	0
0	3	0

Table with 5 columns: Maximum Delay (in seconds) by hour and forecast scenario for each junction, Thresholds, Red (>= 30), Amber (< 30), Green (< 20), and Difference.

Uses demand flows that include fuel & income adjustment

Junction 28
Name A12 / A1152 Woods Lane
Sheet J28
Streams 3
Package Junctions 9

Table for Junction 28 showing demand flows for Base, 2023, 2028, and 2034 across time slots 06:00-07:00 to 17:00-18:00. Columns include RC, EY, PC, and OP.

Table showing Difference for Junction 28 across years 2023, 2028, and 2034 for EY-RC, PC-RC, and OP-RC.

Uses actual flows that exclude fuel & income adjustment

Junction 28_sens
Name A12 / A1152 Woods Lane
Sheet J28_sens
Streams 3
Package VISSIM / Junctions 9

Table for Junction 28_sens showing actual flows for Base, 2023, 2028, and 2034 across time slots 06:00-07:00 to 17:00-18:00.

Table showing Difference for Junction 28_sens across years 2023, 2028, and 2034.

J29 Option 3 as detailed in TA Addendum Chapter 9

Junction 29_med_cwwidth
Name A12 / New Road / Woodbridge Road
Sheet J29_med_cwwidth
Streams 6
Package Junctions 9

Table for Junction 29_med_cwwidth showing demand flows for Base, 2023, 2028, and 2034 across time slots 06:00-07:00 to 17:00-18:00.

Table showing Difference for Junction 29_med_cwwidth across years 2023, 2028, and 2034.

Junction 30
Name A12 / Button's Rd / Glemham Hall
Sheet J30
Streams 4
Package Junctions 9

Table for Junction 30 showing demand flows for Base, 2023, 2028, and 2034 across time slots 06:00-07:00 to 17:00-18:00.

Table showing Difference for Junction 30 across years 2023, 2028, and 2034.

Junction 31
Name A12 / A145
Sheet J31
Streams 3
Package Junctions 9

Table for Junction 31 showing demand flows for Base, 2023, 2028, and 2034 across time slots 06:00-07:00 to 17:00-18:00.

Table showing Difference for Junction 31 across years 2023, 2028, and 2034.

Junction 32a
Name A12 / A1095 East
Sheet J32a
Streams 2
Package Junctions 9

Table for Junction 32a showing demand flows for Base, 2023, 2028, and 2034 across time slots 06:00-07:00 to 17:00-18:00.

Table showing Difference for Junction 32a across years 2023, 2028, and 2034.

Junction 32b
Name A12 / A1095 West
Sheet J32b
Streams 2
Package Junctions 9

Table for Junction 32b showing demand flows for Base, 2023, 2028, and 2034 across time slots 06:00-07:00 to 17:00-18:00.

Table showing Difference for Junction 32b across years 2023, 2028, and 2034.

Junction 32c
Name A1095 / Slip Road
Sheet J32c
Streams 2
Package Junctions 9

Table for Junction 32c showing demand flows for Base, 2023, 2028, and 2034 across time slots 06:00-07:00 to 17:00-18:00.

Table showing Difference for Junction 32c across years 2023, 2028, and 2034.

Junction 34a
Name A12 Northbound off slip / B1078
Sheet J34a
Streams 2
Package Junctions 9

Table for Junction 34a showing demand flows for Base, 2023, 2028, and 2034 across time slots 06:00-07:00 to 17:00-18:00.

Table showing Difference for Junction 34a across years 2023, 2028, and 2034.

Junction 34bc
Name A12 Southbound on-slip / A12 Southbound off-slip / B1078
Sheet J34bc
Streams 5
Package Junctions 9

Table for Junction 34bc showing demand flows for Base, 2023, 2028, and 2034 across time slots 06:00-07:00 to 17:00-18:00.

Table showing Difference for Junction 34bc across years 2023, 2028, and 2034.

Junction 35a
Name A12 / Mitford Road
Sheet J35a
Streams 3
Package Junctions 9

Table for Junction 35a showing demand flows for Base, 2023, 2028, and 2034 across time slots 06:00-07:00 to 17:00-18:00.

Table showing Difference for Junction 35a across years 2023, 2028, and 2034.

Junction 35b
Name A12 / B1121 Main Road
Sheet J35b
Streams 3
Package Junctions 9

Table for Junction 35b showing demand flows for Base, 2023, 2028, and 2034 across time slots 06:00-07:00 to 17:00-18:00.

Table showing Difference for Junction 35b across years 2023, 2028, and 2034.

Maximum Delay (in seconds) by hour and forecast scenario for each junction		Thresholds	Red >= 30	Amber < 30	Green < 20	Difference					
Junction Name	35c B1121 Main Road / Slip Road	Base	2023		2028		2034		2023	2028	2034
Sheet	J35c		RC	EY	RC	PC	RC	OP	EY-RC	PC-RC	OP-RC
Streams	2	06:00-07:00	0	0	0	5	5	5	0	5	0
Package	Junctions 9	07:00-08:00	5	5	6	6	6	6	0	0	0
		08:00-09:00	5	6	6	6	6	7	0	0	0
		15:00-16:00	6	6	6	6	6	6	0	0	0
		17:00-18:00	5	5	5	6	6	6	0	0	0
Junction Name	36a A12 / Main Road	Base	2023		2028		2034		2023	2028	2034
Sheet	J36a		RC	EY	RC	PC	RC	OP	EY-RC	PC-RC	OP-RC
Streams	3	06:00-07:00	7	7	7	7	7	7	0	0	0
Package	Junctions 9	07:00-08:00	9	10	12	10	11	10	2	1	0
		08:00-09:00	11	11	12	11	12	12	1	1	1
		15:00-16:00	10	10	11	11	12	11	0	1	0
		17:00-18:00	9	9	10	9	10	10	1	1	0
As per DCO Transport Assessment											
Junction Name	36b A12 Slip / Main Road	Base	2023		2028		2034		2023	2028	2034
Sheet	J36b		RC	EY	RC	PC	RC	OP	EY-RC	PC-RC	OP-RC
Streams	2	06:00-07:00	5	5	5	5	5	5	0	0	0
Package	Junctions 9	07:00-08:00	6	6	6	6	6	6	0	0	0
		08:00-09:00	6	6	6	6	6	6	0	0	0
		15:00-16:00	6	6	6	6	6	6	0	0	0
		17:00-18:00	6	6	6	6	6	6	0	0	0
Junction Name	37 A12 / B1387	Base	2023		2028		2034		2023	2028	2034
Sheet	J37		RC	EY	RC	PC	RC	OP	EY-RC	PC-RC	OP-RC
Streams	3	06:00-07:00	12	12	12	12	14	13	0	2	0
Package	Junctions 9	07:00-08:00	16	16	18	17	19	17	2	2	0
		08:00-09:00	17	18	18	18	19	18	0	1	-3
		15:00-16:00	11	12	12	12	13	13	0	1	0
		17:00-18:00	10	10	10	10	11	11	0	0	0
Junction Name	38 A12 / B1125 Angel Lane	Base	2023		2028		2034		2023	2028	2034
Sheet	J38		RC	EY	RC	PC	RC	OP	EY-RC	PC-RC	OP-RC
Streams	2	06:00-07:00	10	10	11	10	12	11	1	2	0
Package	Junctions 9	07:00-08:00	16	17	25	17	22	18	9	5	0
		08:00-09:00	18	19	21	20	21	21	2	2	0
		15:00-16:00	22	24	27	25	34	30	4	9	0
		17:00-18:00	15	19	38	20	22	16	19	3	0
Junction Name	39 A12 / Mariesford Road	Base	2023		2028		2034		2023	2028	2034
Sheet	J39		RC	EY	RC	PC	RC	OP	EY-RC	PC-RC	OP-RC
Streams	3	06:00-07:00	6	6	7	6	6	6	0	0	0
Package	Junctions 9	07:00-08:00	16	18	32	20	25	21	14	5	1
		08:00-09:00	7	8	8	8	9	7	1	1	0
		15:00-16:00	17	20	23	22	30	25	3	8	0
		17:00-18:00	8	9	9	9	9	9	0	0	0
Junction Name	40 A12 / Bell Lane	Base	2023		2028		2034		2023	2028	2034
Sheet	J40		RC	EY	RC	PC	RC	OP	EY-RC	PC-RC	OP-RC
Streams	3	06:00-07:00	10	11	13	11	12	11	2	1	0
Package	Junctions 9	07:00-08:00	19	24	65	28	41	30	41	12	2
		08:00-09:00	24	33	55	42	83	34	22	41	1
		15:00-16:00	23	28	36	34	61	42	7	28	1
		17:00-18:00	21	28	45	32	48	33	17	17	1
Junction Name	41 A1156 / Felixstowe Road	Base	2023		2028		2034		2023	2028	2034
Sheet	J41		RC	EY	RC	PC	RC	OP	EY-RC	PC-RC	OP-RC
Streams	3	06:00-07:00	10	10	10	9	9	9	0	0	0
Package	Junctions 9	07:00-08:00	14	14	14	14	14	15	0	0	0
		08:00-09:00	19	20	21	22	21	27	1	-1	1
		15:00-16:00	16	19	19	21	21	28	0	0	0
		17:00-18:00	19	24	25	28	28	38	1	0	-1
Junction Name	42_miti A12 / Sizewell Link Road	Base	2023		2028		2034		2023	2028	2034
Sheet	J42_miti		RC	EY	RC	PC	RC	OP	EY-RC	PC-RC	OP-RC
Streams	3	06:00-07:00				5		4			
Package	Junctions 9	07:00-08:00				8		6			
		08:00-09:00				7		6			
		15:00-16:00				9		7			
		17:00-18:00				7		6			
Junction Name	43_miti B1122 / Site Access	Base	2023		2028		2034		2023	2028	2034
Sheet	J43_miti		RC	EY	RC	PC	RC	OP	EY-RC	PC-RC	OP-RC
Streams	5	06:00-07:00		4		7		4			
Package	Junctions 9	07:00-08:00		8		8		5			
		08:00-09:00		6		8		8			
		15:00-16:00		4		8		3			
		17:00-18:00		5		10		4			
Junction Name	44_miti B1122 / Lover's Lane	Base	2023		2028		2034		2023	2028	2034
Sheet	J44_miti		RC	EY	RC	PC	RC	OP	EY-RC	PC-RC	OP-RC
Streams	3	06:00-07:00	7	7	7	8	7	7	0	1	0
Package	Junctions 9	07:00-08:00	9	11	10	14	8	9	2	5	1
		08:00-09:00	11	12	11	11	9	11	2	0	2
		15:00-16:00	10	14	10	12	10	10	4	2	0
		17:00-18:00	9	19	9	13	8	9	9	5	0
Junction Name	45_miti A12 / Tinker Brook	Base	2023		2028		2034		2023	2028	2034
Sheet	J45_miti		RC	EY	RC	PC	RC	OP	EY-RC	PC-RC	OP-RC
Streams	4	06:00-07:00				5		5			
Package	Junctions 9	07:00-08:00				9		9			
		08:00-09:00				9		9			
		15:00-16:00				10		9			
		17:00-18:00				7		6			

APPENDIX 9B

Yoxford VISSIM Model



EDF Energy

SIZEWELL C – YOXFORD MICROSIMULATION MODELLING

Model Validation and Forecasting Report



50400326

December 2020 CONFIDENTIAL



EDF Energy

SIZEWELL C – YOXFORD MICROSIMULATION MODELLING

Model Validation and Forecasting Report

50400326 CONFIDENTIAL

PROJECT NO. 50400326

OUR REF. NO. 50400326

DATE: December 2020

WSP

62-64 Hills Road

Cambridge

CB2 1LA

Phone: +44 1223 558 050

Fax: +44 1223 558 051

WSP.com



QUALITY CONTROL

Issue/revision	First issue	Revision 1	Revision 2	Revision 3
Remarks	Draft	Revision 1	Revision 2	Revision 3
Date	30/10/2015	13/11/2018	07/01/2020	18/12/2020
Prepared by	QN	ECF	ECF LL	ECF
Checked by	NC	SL SP	SL SP	LL
Authorised by	JH	JH	SB	SL
Project number	50400326			
Report number				
File reference	Appendix 9B – Yoxford VISSIM technical note			

CONTENTS

1.	PROJECT BACKGROUND	1
1.1.	SIZEWELL C PROPOSALS	1
1.2.	STRATEGIC TRAFFIC MODELLING	1
1.3.	PURPOSE OF VISSIM MODELLING	2
2.	METHODOLOGY	3
3.	BASE MODEL DEVELOPMENT	5
3.1.	STUDY AREA	5
3.2.	DATA COLLECTION	6
	TRAFFIC COUNTS AND QUEUE LENGTHS	6
	JOURNEY TIMES	9
	LEVEL CROSSING SURVEY	10
	SITE OBSERVATIONS	11
3.3.	MODEL CONSTRUCTION	11
	BASE NETWORK STRUCTURE	11
	BASE YEAR MATRIX DEVELOPMENT	13
	PUBLIC TRANSPORT SERVICES	14
4.	BASE MODEL CALIBRATION AND VALIDATION	16
4.1.	CRITERIA	16
4.2.	TRAFFIC FLOW CALIBRATION	17
	AM PEAK HOUR (08:00 – 09:00)	17
	INTER PEAK HOUR (15:00 – 16:00)	18
	PM PEAK HOUR (17:00 – 18:00)	19
4.3.	QUEUE LENGTH CALIBRATION	20
	AM PEAK HOUR (08:00 – 09:00)	20

INTER PEAK HOUR (15:00 – 16:00)	22
PM PEAK HOUR (17:00 – 18:00)	24
4.4. JOURNEY TIME VALIDATION	27
AM PEAK HOUR (08:00 – 09:00)	27
INTER PEAK HOUR (15:00 – 16:00)	29
PM PEAK HOUR (17:00 – 18:00)	31
4.5. SUMMARY OF MODEL CALIBRATION AND VALIDATION	32
5. FORECAST SCENARIO – 2023 EARLY YEARS	33
<hr/>	
5.1. SCENARIO ASSUMPTIONS	33
TRANSPORT NETWORK ASSUMPTIONS	34
TRAFFIC DEMAND ASSUMPTIONS - 2023	36
5.2. SCENARIO PERFORMANCE COMPARISON	40
NETWORK-WIDE PERFORMANCE	40
JUNCTION PERFORMANCE	42
PERFORMANCE SUMMARY	52
6. FORECAST SCENARIO – 2028 PEAK CONSTRUCTION	54
<hr/>	
6.1. SCENARIO ASSUMPTIONS	54
TRANSPORT NETWORK ASSUMPTIONS	54
TRAFFIC DEMAND ASSUMPTIONS - 2028	56
6.2. SCENARIO PERFORMANCE COMPARISON	58
NETWORK-WIDE PERFORMANCE	58
JUNCTION PERFORMANCE	59
PERFORMANCE SUMMARY	72
7. FORECAST SCENARIO – 2034 OPERATIONAL PHASE	73
<hr/>	
7.1. SCENARIO ASSUMPTIONS	73
TRANSPORT NETWORK ASSUMPTIONS	73
TRAFFIC DEMAND ASSUMPTIONS - 2034	73
7.2. SCENARIO PERFORMANCE COMPARISON	74

NETWORK-WIDE PERFORMANCE	74
JUNCTION PERFORMANCE	76
PERFORMANCE SUMMARY	86
8. CONCLUSIONS	87
9. LIMITATIONS	89

TABLES

Table 1 – Modelled Scenarios	3
Table 2 – TrafficMaster Observed Journey Times (seconds)	10
Table 3 – Level Crossing Barrier Closure Duration (seconds)	11
Table 4 – Zoning System	13
Table 5 – Public Bus Services Frequencies per 3hr (AM) or 4hr (PM) period	14
Table 6 – Train Service Frequency per 3hr (AM) and 4hr (PM) period	15
Table 7 – Traffic Flow Calibration Criteria (source: TAG Unit 3.1)	16
Table 8 – Journey Time Validation Criteria (source: TAG Unit 3.1)	17
Table 9 – AM Peak Hour Turn Flow Validation Summary	17
Table 10 – Interpeak Hour Turn Flow Validation Summary	18
Table 11 – PM Peak Hour Turn Flow Validation Summary	19
Table 12 – AM Peak Hour Observed and Modelled Journey Times	27
Table 13 – Inter Peak Hour Observed and Modelled Journey Times	29
Table 14 – PM Peak Hour Observed and Modelled Journey Times	31
Table 15 – Major and minor road classification	37
Table 16 – 2023 Demand input sources	38
Table 17 – 2023 Network Traffic Reference Case (in vehicles per hour)	38
Table 18 – 2023 Network Traffic Early Years (in vehicles per hour)	39
Table 19 – 2023 Early Years Sizewell Bus services	39
Table 20 – 2023 Early Years HGV deliveries	40

Table 21 – Network Performance Model Results	41
Table 22 – A12 / A1120 queue spillback analysis – AM period	45
Table 23 – A12 / A1120 queue spillback analysis – PM period	46
Table 24 – A12 / B1122 delay analysis	48
Table 25 – A12 / B1122 queue spillback analysis – AM period	48
Table 26 – A12 / B1122 PM delay analysis	49
Table 27 – A12 / B1122 queue spillback analysis – PM period	50
Table 28 – 2028 Network Traffic Reference Case (in vehicles per hour)	56
Table 29 – 2028 Network Traffic Peak Construction (in vehicles per hour)	57
Table 30 – 2028 Sizewell C Bus services	57
Table 31 – 2028 Sizewell C HGV deliveries	58
Table 32 – Network Performance Model Results	58
Table 33 – A12 / A1120 queue spillback analysis – AM period	62
Table 34 – A12 / A1120 queue spillback analysis – PM period	63
Table 35 – A12 / B1122 AM spillback analysis	65
Table 36 – A12 / B1122 AM delay analysis	65
Table 37 – A12 / B1122 queue spillback analysis – PM period	67
Table 38 – A12 / B1122 PM maximum delay analysis	67
Table 39 – 2034 Network Traffic Reference Case (in vehicles per hour)	74
Table 40 – 2034 Network Traffic Operational Phase (in vehicles per hour)	74
Table 41 – 2034 Sizewell C HGV deliveries	74
Table 42 – Network Performance Model Results	75
Table 43 – A12 / A1120 queue spillback analysis – AM period	79
Table 44 – A12 / A1120 queue spillback analysis – PM period	80
Table 45 – A12 / B1122 AM spillback analysis	81
Table 46 – A12 / B1122 AM maximum delay analysis	82
Table 47 – A12 / B1122 queue spillback analysis – PM period	83
Table 48 – A12 / B1122 PM maximum delay analysis	84

FIGURES

Figure 1 – Modelled Study Area	6
Figure 2 – MCC and Queue Length Survey Locations	8
Figure 3 – Observed Journey Time Segments	9
Figure 4 – Level Crossing Survey Locations	10
Figure 5 – AM Peak Hour Plot of Modelled vs. Observed Turn Flows	18
Figure 6 – Inter Peak Hour Plot of Modelled vs. Observed Turn Flows	19
Figure 7 – PM Peak Hour Plot of Modelled vs. Observed Turn Flows	20
Figure 8 – A12 Level Crossing Queue Length Validation (AM peak)	21
Figure 9 – B1122 Level Crossing Queue Length Validation (AM peak)	22
Figure 10 – A12 Level Crossing Queue Length Validation (Inter peak)	23
Figure 11 – B1122 Level Crossing Queue Length Validation (Inter peak)	24
Figure 12 – A12 Level Crossing Queue Length Validation (PM peak)	25
Figure 13 – B1122 Level Crossing Queue Length Validation (PM peak)	26
Figure 14 – AM Peak Hour Journey Time Segments	27
Figure 15 – AM Peak Hour Journey Time Northbound	28
Figure 16 – AM Peak Hour Journey Time Southbound	28
Figure 17 – Inter Peak Hour Journey Time Segments	29
Figure 18 – Inter Peak Hour Journey Time Northbound	30
Figure 19 – Inter Peak Hour Journey Time Southbound	30
Figure 20 – PM Peak Hour Journey Time Segments	31
Figure 21 – PM Peak Hour Journey Time Northbound	32
Figure 22 – PM Peak Hour Journey Time Southbound	32
Figure 23 – Proposed HGV delivery profile	34
Figure 24 – Temporary bus stop and HGV delivery access at Yoxford junction	35
Figure 25 – Northern P&R site access	35
Figure 26 – VISUM subnetwork in the modelled area	36
Figure 27 – 2023 A12 Journey Time comparison	42
Figure 28 – Junction Average Delay	43
Figure 29 – A12 / A1120 AM Queue lengths	44
Figure 30 – A12 / A1120 PM Queue lengths	46
Figure 31 – A12 / B1122 AM Queue lengths	47

Figure 32 – A12 / B1122 PM Queue lengths	49
Figure 33 – A12 / A144 AM Queue lengths	51
Figure 34 – A12 / A144 PM Queue lengths	52
Figure 35 – A12 / B1122 junction before and after embedded mitigation	55
Figure 36 – Northern park and ride site access before and after construction	55
Figure 37 – A12 / A144 junction before and after construction	56
Figure 38 – 2028 Journey Time Comparison	59
Figure 39 – Junction Average Delay	60
Figure 40 – A12 / A1120 AM Queue lengths	61
Figure 41 – A12 / A1120 PM Queue lengths	63
Figure 42 – A12 / B1122 AM Queue lengths	64
Figure 43 – A12 / B1122 PM Queue lengths	66
Figure 44 – A12 / A144 AM Queue lengths	68
Figure 45 – A12 / A144 PM Queue lengths	69
Figure 46 – Northern park and ride roundabout AM Queue lengths	70
Figure 47 – Northern park and ride roundabout PM Queue lengths	71
Figure 48 – 2034 Journey Time Comparison	76
Figure 49 – Junction Average Delay	77
Figure 50 – A12 / A1120 AM Queue lengths	78
Figure 51 – A12 / A1120 PM Queue lengths	79
Figure 52 – A12 / B1122 AM Queue lengths	81
Figure 53 – A12 / B1122 PM Queue lengths	83
Figure 54 – A12 / A144 AM Queue lengths	85
Figure 55 – A12 / A144 PM Queue lengths	86

APPENDICES

APPENDIX A

NETWORK TRAFFIC FLOW DIAGRAMS

APPENDIX B

BASE MODEL VALIDATION FIGURES



APPENDIX C

2023 FORECAST MODEL RESULTS

APPENDIX D

2028 FORECAST MODEL RESULTS

APPENDIX E

2034 FORECAST MODEL RESULTS

APPENDIX F

JUNCTION MITIGATION DESIGNS

APPENDIX G

SZC WORKER PROFILING

1. PROJECT BACKGROUND

1.1. SIZEWELL C PROPOSALS

- 1.1.1. Sizewell C Co. is proposing to expand the existing nuclear power station at Sizewell on the Suffolk coast on land immediately to the north of the existing Sizewell B site. The Sizewell C Project (the Project) would be one of the biggest and most technologically complex construction projects ever built in the UK.
- 1.1.2. The construction of Sizewell C would involve the daily movement of large numbers of construction workers as well as the movement of large amounts of building materials and equipment. The peak construction workforce for Sizewell C is anticipated to be 7,900 construction workers and 600 associated development workers. The current associated development proposals include:
- An on-site accommodation campus, as well as a number of caravans on nearby land east of Eastlands Industrial Estate (LEEIE), helping to significantly reduce the number of workforce journeys through towns and villages close to the construction site;
 - Two park and ride sites, one for construction workers approaching Sizewell from the north on the A12 and the other for those approaching from the south on the A12;
 - A freight management facility on Felixstowe Road, west of the Seven Hills A12/A14 junction;
 - A two village bypass, around Farnham and Stratford St Andrew;
 - Sizewell Link Road, joining the A12 south of Yoxford to the B1122 east of Theberton: and
 - A12 / B1122 Yoxford roundabout and other highway improvements.

1.2. STRATEGIC TRAFFIC MODELLING

- 1.2.1. A VISUM strategic traffic model was developed for the purposes of assessing Sizewell C traffic impacts. The study area and modelled network for the VISUM model was agreed with the local highway authority, Suffolk County Council (SCC) and extends to Lowestoft to the north, Ipswich to the south and the A140 to the west.
- 1.2.2. A VISUM Base Model of the existing road network has been developed using a wide range of Manual Classified Counts (MCC) and Automatic Traffic Counts (ATC) on the local road network which were conducted in May 2015, and from count information from the Highway England Traffic Flow Data System (TRADS) which holds information on traffic flows at sites on the motorway and trunk road network. In addition, SCC provided count data from a number of their permanent count sites.
- 1.2.3. A number of forecast scenarios were modelled in VISUM to represent 2023, 2028 and 2034. Each year was modelled as a Reference Case, without the addition of Sizewell C related traffic and a 'with-Sizewell' scenario known respectively as the Early Years, Peak Construction and Operational Phase scenarios. The Reference Case scenarios assume increases in traffic levels arising from general growth as well as the additional traffic associated with major development sites nearby. Committed highway schemes are also included in these scenarios. The forecast Sizewell C VISUM scenarios were developed based on assumptions about construction traffic provided by EDF and results from a bespoke gravity model.
- 1.2.4. The VISUM model was developed for seven individual hours; three AM hour models and four PM hour models as follows:

- 06:00 to 09:00 hours
- 15:00 to 19:00 hours

1.2.5. Details of the VISUM model development are provided in chapters 6 to 8 of the Sizewell C Transport Assessment.

1.3. PURPOSE OF VISSIM MODELLING

- 1.3.1. The Sizewell C Joint Local Authority Group (JLAG) raised concerns about the operation of the highway network at Yoxford and at Darsham at a meeting on 17 July 2015. The purpose of this modelling study is to determine the impact of Sizewell C traffic on the area around Yoxford, with particular emphasis on the A12 junctions, including the A1120 and B1122 in Yoxford and the A144. The study would also inform design of the northern park & ride access and consider the interaction of these works with the remainder of the highway network in the area.
- 1.3.2. The VISSIM modelling reported here draws on the gravity modelling and VISUM strategic traffic modelling and adopts the same forecast years and construction traffic movement assumptions made for those studies. The VISUM strategic modelling includes trips associated with the periodical outages at Sizewell B (typically over a six week period every 18 months) as agreed with SCC.
- 1.3.3. In turn, all of the VISSIM modelling presented in this note includes Sizewell B outage trips, thus representing a worst-case scenario which allows a robust network performance assessment to be undertaken.

2. METHODOLOGY

- 2.1.1. A VISSIM microsimulation model was developed in VISSIM 9.00-12. The first step in this process was to produce a base traffic network within the VISSIM scenario management framework. This base network includes all settings, network objects and base data, and serves as a template which forms the basis of all model scenarios. Full details of the base model development are provided in Chapter 3.
- 2.1.2. A total of fourteen scenarios were created within the scenario managed file by applying various combinations of modifications to the base network. A brief description of each of the fourteen scenarios that have been modelled is given in Table 1.

Table 1 – Modelled Scenarios

Scenario Number	Name	Description
1 - 2	2015 AM/PM	2015 Base Year – base 2015 flows.
3 – 4	2023 RC AM/PM	2023 Reference Case – 2023 flows with no Sizewell traffic and no mitigation.
5 – 6	2023 EY AM/PM	2023 Early Years - 2023 flows with early Sizewell traffic and no mitigation.
7 – 8	2028 RC AM/PM	2028 Reference Case – 2028 flows with no Sizewell traffic and no mitigation.
9 – 10	2028 PC AM/PM	2028 Peak Construction – 2028 flows with Sizewell traffic and the following embedded mitigations: A12 / B1122 roundabout, A12 / A144 upgrade, northern park and ride, new park and ride roundabout and Sizewell Link Road.
11 – 12	2034 RC AM/PM	2034 Reference Case – 2034 flows with no Sizewell traffic and no mitigation.
13 – 14	2034 OP AM/PM	2034 Operational Phase – 2034 flows with Sizewell traffic and the following embedded mitigations: A12 / B1122 roundabout, A12 / A144 upgrade and Sizewell Link Road.

- 2.1.3. The AM scenarios were modelled from 06:00 to 09:00, while the PM scenarios were from 15:00 to 19:00. Longer modelled periods were deliberately selected so that the assessment could take into account both the traditional highway peak periods when general traffic flows are high and Sizewell traffic is anticipated to be low and also the early morning and afternoon periods (06:00-08:00 and 15:00-16:00) when general traffic is lower but Sizewell traffic is at its peak.
- 2.1.4. Scenarios 1 and 2 represent the current base year conditions. Base year traffic was obtained from Manual Classified Counts, which were processed to estimate complete origin-destination routes and coded into the model as dynamic OD matrices. For the purposes of base year calibration and validation, three time periods were selected: 08:00 – 09:00, 15:00 - 16:00 and 17:00 - 18:00. The base model was validated against 2015 junction queue lengths and journey time data for these three hours. The base year model validation and calibration is detailed in Chapter 4.

- 2.1.5. Scenarios 3 to 6 model the forecast year 2023. Growth in background traffic and Sizewell C construction traffic were obtained from the strategic highway model (VISUM) and assigned dynamically to the VISSIM model. A small number of roads are included in the micro-level VISSIM model but are not included in the macro-level VISUM model. For trips originating or terminating at these locations, growth has been estimated using TEMPro growth factors instead of the VISUM model.
- 2.1.6. Scenarios 3 and 4 represent the 2023 Reference Case scenario, which predicts the operation of the highway network under a “do nothing” scenario – i.e. forecast population and employment growth, but no Sizewell C construction activity. Scenarios 5 and 6 represent the 2023 Early Years scenario, which adds the Sizewell C construction traffic to the Reference Case scenario. The transport network and traffic demand assumptions used to build the Early Years scenario and a summary of its performance compared to the Reference Case and Base Year are detailed in Chapter 5.
- 2.1.7. Scenarios 7 to 10 represent the forecast year 2028. This year marks the period of peak construction activity at Sizewell C. Scenarios 7 and 8 develop the Reference Case, which predicts the operation of the highway network under a “do nothing at Sizewell” scenario. Scenarios 9 and 10 represent the 2028 Peak Construction scenario, which adds the Sizewell C peak construction traffic to the Reference Case scenario. The transport network and traffic demand assumptions used to build the Peak Construction scenario and a summary of its performance compared to the Reference Case and Base Year are detailed in Chapter 6.
- 2.1.8. Scenarios 11 to 14 model the forecast year 2034. This year represents the normal operation of Sizewell C once it has been fully constructed. Scenarios 11 and 12 model the Reference Case scenario, which predicts the operation of the highway network under a “do nothing at Sizewell” scenario. Scenarios 13 and 14 represent the 2034 Operational Phase scenario, which adds the Sizewell C operational traffic to the Reference Case scenario. The transport network and traffic demand assumptions used to build the Peak Construction scenario and a summary of its performance compared to the Reference Case and Base Year are detailed in Chapter 7.

3. BASE MODEL DEVELOPMENT

3.1. STUDY AREA

- 3.1.1. The VISSIM model network extent has been chosen based on the anticipated Sizewell C area of impact which includes a number of network locations which are more sensitive to growth in traffic flows. The modelled extent covers the A12 between Yoxford and the A12 junction with the A144, including junctions with the A1120, B1122, Westleton Road, Darsham service station, The Street, Willow Marsh Lane, Lymballs Lane and A144. The proposed Sizewell Link Road and its junctions with the A12 and B1122 are not covered in this model as they are already accounted for in the standalone Junctions 9 modelling.
- 3.1.2. The extent of the B1122 is sufficient to capture the rail level crossing just east of Rookery Park. The level crossings on the A12 at Darsham station and on Willow Marsh Lane are also included within the model along with the Darsham Service Station entrance / exit. Darsham Nurseries (garden centre) access has not been included in the model as it is not anticipated that flows accessing the nurseries would be significant during the weekday peak periods.
- 3.1.3. The Old High Road was originally considered in the model, but the surveys at the junctions with the A12 and A1120 show low turning flows and has therefore not been included in the model. There is a chance that vehicles might use Old High Road to rat run, but this is likely to be minimal because Old High Road also has on-street parking and many driveways. This means the A12/A1120 junction may have slightly higher flows which should provide a robust assessment.
- 3.1.4. The modelled area is shown in Figure 1.

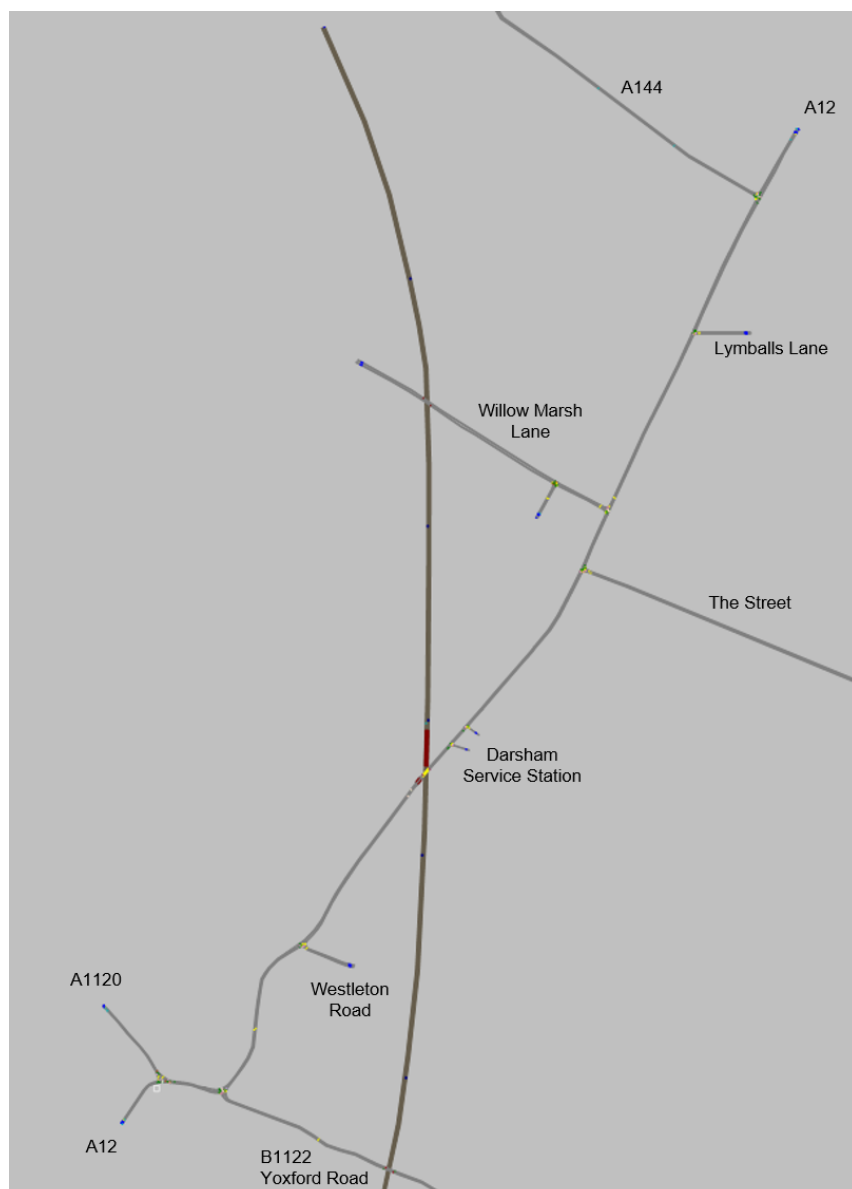

Figure 1 – Modelled Study Area

3.2. DATA COLLECTION

TRAFFIC COUNTS AND QUEUE LENGTHS

3.2.1. Manual classified counts (MCCs) and queue length observations were recorded at each of the major junctions in the study area to allow the VISSIM model to be calibrated. The strategic VISUM modelling represents an average Monday to Thursday during AM modelled hours and a Friday during PM modelled hours, as this was shown to be busier than other weekdays. In line with this, MCCs and queues were collected for the purpose of the VISSIM modelling on Friday 8 May 2015 (3-7pm) and Monday 11 May 2015 (6-10am) at the following locations:

- A12 Brook Street / A1120 High Street, Yoxford;
- A12 Brook Street / B1122 Middleton Road;
- A12 Main Road / Petrol Filling Station near Darsham; and

- A12 London Road / A144.

3.2.2. Additional MCCs and queue lengths were collected along the A12 to infill the MCC and queue data collected in May 2015. MCCs and queue lengths were recorded on Wednesday 30 September 2015 (6-10am, 12-2pm, 3-7pm) at the following locations:

- A12 / Westleton Road;
- A12 / The Street;
- A12 / Willow Marsh Lane; and
- A12 / Lymballs Lane.

3.2.3. Queue lengths and barrier down times were also recorded at the level crossings on the A12 near Darsham and on the B1122.

3.2.4. All traffic surveys were conducted using cameras installed on-site by Traffic Survey Partners (TSP). Traffic counts were reported in 15-minute time segments and queue lengths were reported in 5-minute time segments. TSP also provided video files for later analysis and verification of processed data. Figure 2 shows the locations of the junctions that were surveyed.

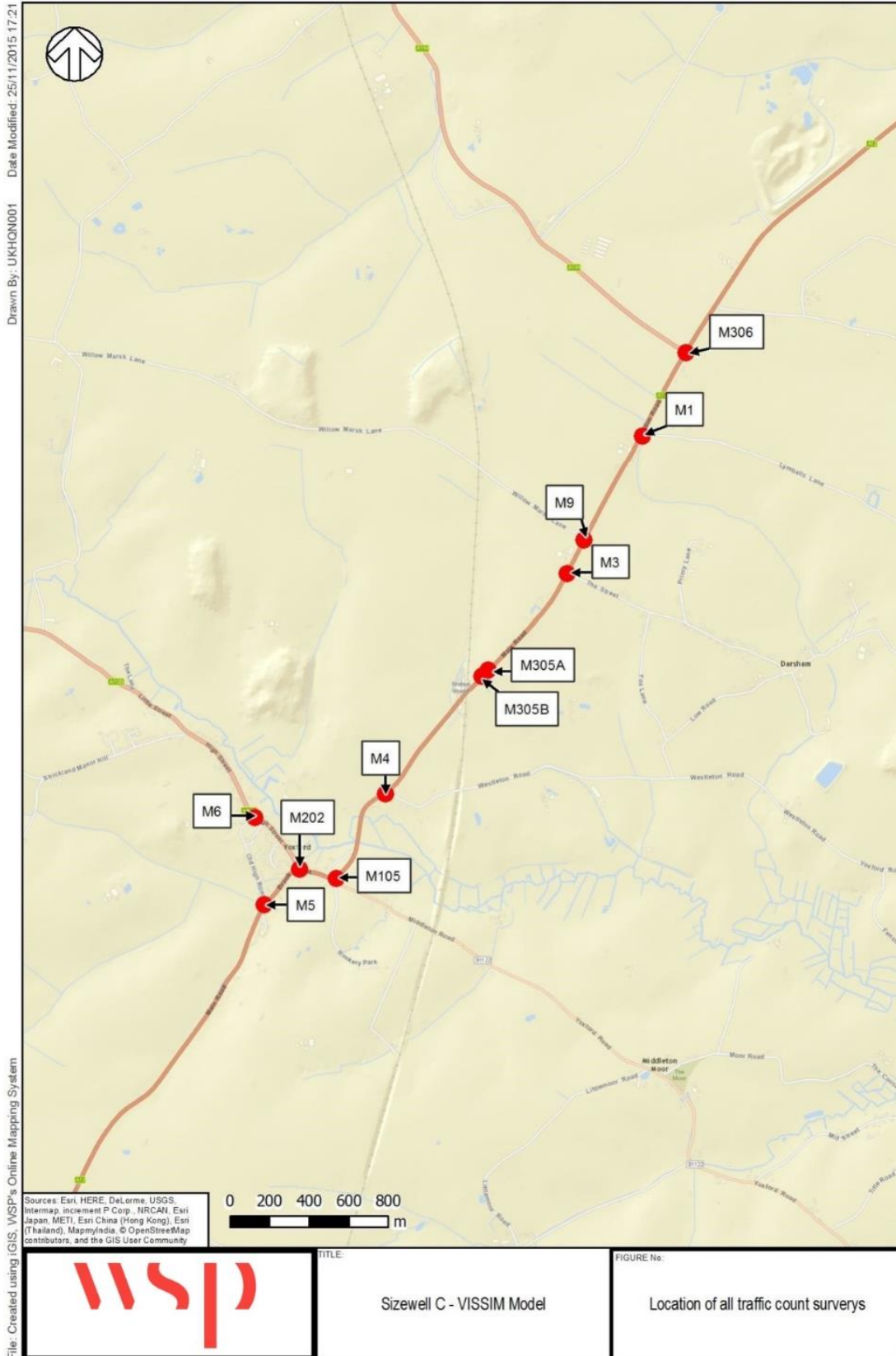

Figure 2 – MCC and Queue Length Survey Locations

JOURNEY TIMES

3.2.5. Highway journey time observations were extracted from TrafficMaster data for four segments along the A12. Journey times from TrafficMaster represent the average weekday travel time across May 2015. Journey times were aggregated from 15-minute segments into whole hours across Monday to Thursdays in May. Journey time data was separated by direction (northbound and southbound) and time period (8-9am, 3-4pm and 5-6pm). The journey time segments are shown in Figure 3.

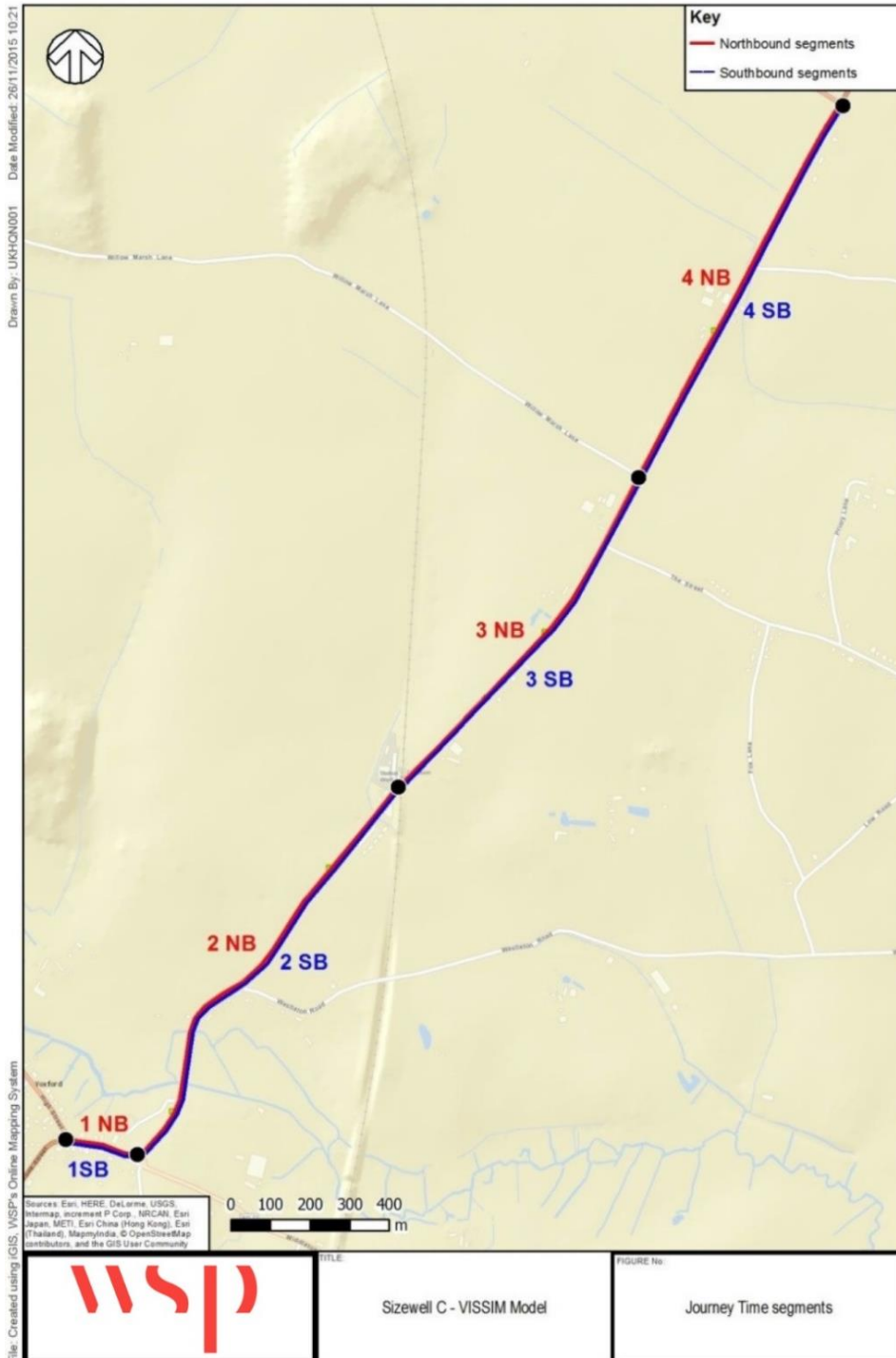

Figure 3 – Observed Journey Time Segments

3.2.6. The observed average journey time data is shown in Table 2.

Table 2 – TrafficMaster Observed Journey Times (seconds)

Section	AM Peak (08:00-09:00)		Inter Peak (15:00-16:00)		PM Peak (17:00-18:00)	
	NB	SB	NB	SB	NB	SB
1	14	13	13	23	16	15
2	60	61	58	62	57	62
3	68	66	72	85	67	72
4	52	48	60	51	48	49
Total	194	187	203	222	188	197

LEVEL CROSSING SURVEY

3.2.7. The operation of the level crossing on the A12 near Darsham and the level crossing on the B1122 Yoxford Road was surveyed on Wednesday 30 September 2015 during the AM, Inter and PM peak periods. Using video footage provided by TSP, the level crossing barrier closures were recorded to determine the time of closure and duration of each closure. Figure 4 shows the location of the level crossing surveys.

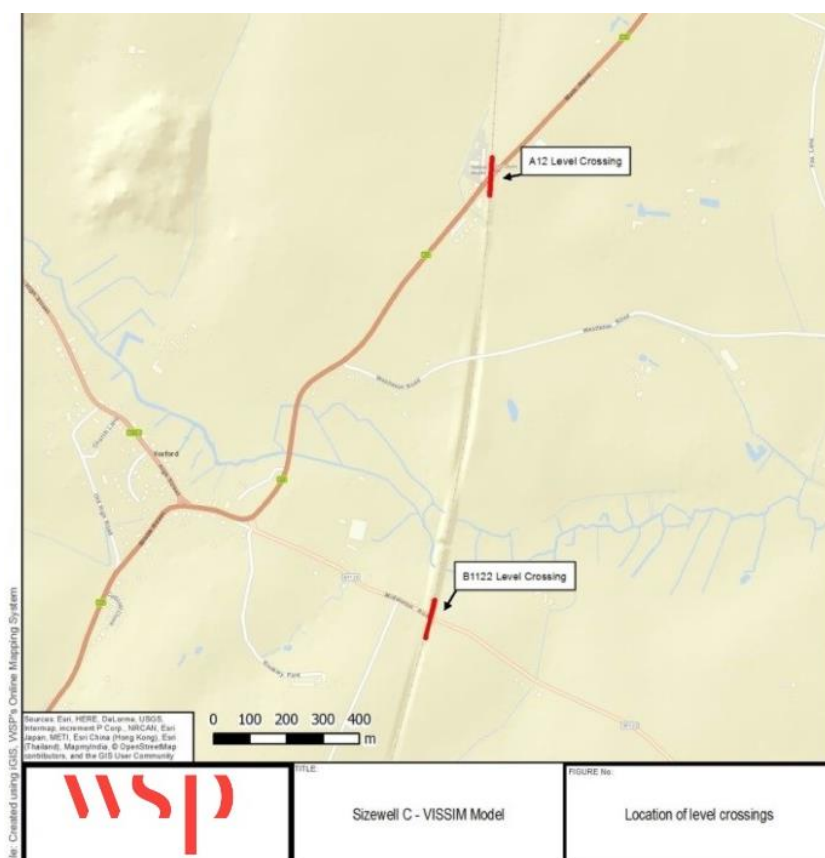

Figure 4 – Level Crossing Survey Locations

3.2.8. The average observed level crossing barrier down time is shown in Table 3.

Table 3 – Level Crossing Barrier Closure Duration (seconds)

Train Arrival Direction and Crossing Location	8-9 AM	3-4 PM	5-6 PM
Northbound train at B1122	31	35	33
Southbound train at B1122	31	37	33
Northbound train at A12	45	45	45
Southbound train at A12	102	135	70

3.2.9. The barrier down time is significantly longer when southbound trains approach the A12 crossing. This is because Darsham railway station is positioned immediately north of the A12 crossing and the barrier is lowered whilst the southbound train dwells at the station before using the crossing.

SITE OBSERVATIONS

3.2.10. A site visit was undertaken on 2nd February 2017 (Thursday) between 16:00 and 18:00. All the study area was observed by car and special attention was paid to the operation of the main junctions. The main conclusions of the site visit are summarised below:

- **A12:** The desired speed of drivers on the A12 varies between 40 and 70mph and often leads to the formation of platoons of vehicles.
- **A12 / B1122 junction:** The junction is situated on a sharp bend. The B1122 approach has a flare length of one vehicle. The right turning movement into the minor arm is difficult due to low visibility, and this movement blocks the right turn out of the minor arm. The major arm right turn flare is three vehicles in length, and no blocking of the mainline was observed during the site visit.
- **A12 / A1120 junction:** The right turn from the major arm into Yoxford High Street blocks the ahead movement. During the site observation, the queue reached up to 3-4 vehicles and did not block back to the B1122 junction. Minor arm right turning vehicles use the right branch and left turning vehicles use the left branch. Yoxford High Street has a considerable amount of on-street parking which means progress can be slow.
- **A12 / A144 junction:** The A144 has a number of bends and the speed distribution is wide, between 40 and 70mph. The minor arm flare is two vehicles in length.

3.3. MODEL CONSTRUCTION

BASE NETWORK STRUCTURE

3.3.1. The modelled study area is described in Section 3.1. This area of road network has been constructed in VISSIM using Ordnance Survey Mastermap. The extent was chosen so that the key junctions of interest were included, as well as sufficient areas of the surrounding network to allow traffic arriving at the key junctions to be accurately modelled, e.g. platooning. The modelled area was also extended where necessary to accommodate current and forecast queues.

3.3.2. The majority of network links were coded as “Inter-urban (motorized) W99” links using the Wiedemann99 car-following model. The number of “observed vehicles” was increased from two to four to improve vehicle interaction and the “minimum lateral distance at 0mph” was obtained from

the TfL template (1.0 m.), otherwise the VISSIM default driver behaviour parameters were retained. A small number of multi-lane links were adjusted to use the “free lane selection” link type to allow vehicles to select the most appropriate lane based on their route, e.g. a right turning vehicle selecting the right-hand lane.

- 3.3.3. Desired speed profiles were created for car, motorcycle and bus as per TfL’s default VISSIM model template. These speed profiles cover the following speed limits: 10mph, 20mph, 30mph, 40mph, 50mph and 60mph. Each speed profile ranges between a lower and upper limit to replicate driver tendency to travel at speeds not exactly equal to the sign-posted speed. The speed profiles for 30mph and 40 mph were adjusted during calibration to a linear distribution with tighter boundaries to allow observed speeds to be better replicated. The speed profile for single carriageway national speed limit roads (60mph for cars and 50mph for HGVs) was adjusted during calibration to match site-specific ATC data (2015, A12 between Willow Marsh Lane and A144). The speed profiles result in the formation of natural platoons on the A12 as faster moving vehicles catch-up with slower moving vehicles. Desired Speed Decisions (DSDs) were applied using these speed profiles in the model to replicate speed limit changes. The speed limit applied on the A12 through Yoxford was 30mph and north of the River Yox the speed limit increases to 40mph. The national speed limit (60mph for cars and 50mph for HGVs) north of Willow Marsh Lane was also applied. The B1122, Willow Marsh Lane and other connecting roads were assigned speed limits of 30mph, whilst the A1120 Yoxford High Street was assigned a desired speed of 20mph to reflect the nature of this area.
- 3.3.4. Reduced Speed Areas (RSAs) were assigned across the model to replicate the need for vehicles to slow down on sharp bends and at junctions. Initially a reduced speed distribution of 10mph was used universally for all reduced speed areas. Reduced speed area distributions were then adjusted during calibration to allow observed queues to be matched. This resulted in changing the reduced speed areas to 20mph at the major junctions (A12 / A1120, A12 / B1122 and A12 / A144), all exits from the A12 and on the A12 level crossing.
- 3.3.5. Stop signs have been included on minor arms in the higher speed limit zone (A144 and Lyball’s Lane junctions) to allow vehicles time to assess gaps on the mainline before joining. Reduced speed areas have been removed where stop signs were added to avoid slowing vehicles excessively.
- 3.3.6. Priority rules were applied at junction conflict points to replicate gap acceptance behaviour. Where appropriate, separate time and distance gap rules were applied. Rules were separated for cars and HGVs where required. Gap acceptance times were selected depending on the nature of the conflict and to calibrate the observed queuing behaviour. Higher gap acceptances were required to achieve safe priority behaviours within the 60mph section of the A12.
- 3.3.7. Level crossings were modelled using VISSIM’s Vehicle Actuated Programming (VAP) language. VAP files were created to close the rail barriers (by means of a red signal) when a train approached the crossing. Approaching trains were detected using “virtual loop detectors” on the rail alignment sections. Closure times were programmed to replicate those observed on-street (see Table 3). Priority rules were also used at level crossings to keep the rail tracks clear of queuing traffic. Reduced speed areas of 20mph were added to the level crossing to simulate traffic slowing whilst passing over the crossing.
- 3.3.8. Two VAP files were created:
 - LevelXingA12_v2.VAP – for the A12 level crossing; and

- LevelXing_v2.VAP – for the B1122 and Willow Marsh Lane crossings.

- 3.3.9. T-junctions with flares were modelled by adding an extra lane at the stopline or by extending the appropriate turning connectors to allow two cars to sit side by side whilst waiting to pull out.
- 3.3.10. Nodes were created at each junction and entry to the model for the dynamic assignment of the origin – destination matrices. The nodes at the entry to the model represent the model zones and they are connected to the network by using “parking lots”. Table 4 contains the list of zones used in the model. Zone 902 (northern park and ride) is included in the base year model as an empty zone that will be used in the forecast year scenarios.

Table 4 – Zoning System

Zone	Name	Zone	Name
506	The Street	15350	B1122
902	Northern park and ride	16000	Westleton Road
14828	A1120	16001	Petrol Station
14830	A12 S	16002	Willow Marsh Lane
14834	A144	16003	Lymballs Lane
15048	A12 N		

- 3.3.11. Junction nodes are used in dynamic assignment to allow / prohibit certain movements (defined as “edges” in VISSIM) in the junction. Edges have been closed where appropriate to avoid vehicle movements that would not happen in reality. Junction nodes have also been used for validation and delay evaluation purposes.
- 3.3.12. Travel time measurements were introduced along the A12 for validation and evaluation purposes, replicating the sections from the observed data shown in Figure 3.
- 3.3.13. Queue counters were added at all give way lines at each of the junctions to allow the modelled queues to be calibrated to the observed queue lengths and to allow a comparison of queues to be made in the forecast scenarios.

BASE YEAR MATRIX DEVELOPMENT

- 3.3.14. The Yoxford VISSIM model contains a total of 11 zones, as specified in Table 4.
- 3.3.15. Five vehicle types were used in the base year model:
- Car (100);
 - LGV (700);
 - HGV (200);
 - Bus (300); and
 - Train (400).
- 3.3.16. Car, LGV, bus and train use the default 2D / 3D model distribution. HGV contains both OGV1 and OGV2 models with a share of 50% each, as observed in the MCC data.

- 3.3.17. Vehicle compositions are used to determine the percentage of each vehicle type in a specific vehicle input or matrix. Matrices have been generated for Car, LGV and HGV separately, so the vehicle compositions are also defined for each vehicle type separately.
- 3.3.18. Vehicle classes are used to group vehicle types for dynamic assignment and evaluation purposes. Vehicle classes have been created for each individual vehicle type.
- 3.3.19. Car, LGV and HGV demand was included in the model as dynamic assignment matrices. Traffic flow spreadsheets were prepared using the surveyed traffic flows to balance total in-flow and out-flow at adjacent traffic counts. As almost all junctions were surveyed there were only minor discrepancies between adjacent counts. O-D matrices were derived by applying surveyed turning proportions to flow inputs at the edges of the model.
- 3.3.20. The matrices for the model cover the AM period (06:00 – 09:00) and PM period (15:00 – 19:00). As mentioned in the methodology, these periods were selected so that the assessment could take into account both the traditional highway peak periods and also the periods (06:00-07:00 and 15:00-16:00) when general traffic is lower but Sizewell traffic is at its peak.
- 3.3.21. Matrix trips were loaded onto the zones in 15-minute segments based on the traffic flow spreadsheets. A 15-minute warm-up period was applied to allow traffic to build up in the modelled network prior to the start of the core modelled period, so that traffic conditions are realistic at the beginning of the modelled period.
- 3.3.22. Junction turning flow diagrams are provided for each time period in Appendix A.

Convergence

- 3.3.23. As mentioned above, traffic flows have been input to the network as dynamically assigned matrices. Although there are no route choices available in the network, dynamic assignment has been used as it is a more efficient way to generate Origin – Destination trips than using fixed routes.
- 3.3.24. An iterative convergence procedure takes place by assigning vehicles to different paths until equilibrium is reached. The criterion for model convergence in the model has been set as follows:
 - Travel time on paths: change of up to 20% on 85% of links;
 - Volume on edges: change of up to 50 vehicles on 98% of edges; and
 - Minimum simulation runs: four.
- 3.3.25. Convergence was reached for each scenario in the minimum permitted amount of simulation runs as there is no route choice in the network.

PUBLIC TRANSPORT SERVICES

- 3.3.26. Three public bus services were identified as running through the study area:
 - Borderbus service no. 521 (Halesworth – Aldeburgh);
 - Framlingham High School services TM01 (Leiston – Framlingham); and
 - TM02 (Reydon – Framlingham).
- 3.3.27. These bus services were added to the model according to published timetables. Table 5 lists the frequency of each bus service as they have been included in the model in each time period.

Table 5 – Public Bus Services Frequencies per 3hr (AM) or 4hr (PM) period

Service and Direction	6-9 AM	3-7 PM
No. 521 northbound	0	2
No. 521 southbound	1	1
TM01 westbound	1	0
TM01 southbound	0	1
TM02 northbound	0	1
TM02 southbound	1	0

- 3.3.28. Bus services were included in the model as fixed public transport lines and in lieu of observed dwell time information, a dwell time distribution has been applied to provide some variation in dwell times with an average of 20 seconds. This is considered to be reasonable for a rural bus service where passenger numbers are unlikely to be large.
- 3.3.29. Train services were included in the model as fixed public transport routes with a stop at Darsham station. Modelling the train services allowed the realistic replication of the level crossing barriers which impact flows on the A12, Willow Marsh Lane and the B1122. The northbound and southbound train services were added to the model according to the published timetable, applying an entry offset equal to the time taken by the train between the entry to the model and the stop at the station. Trains were assumed to stop at Darsham station for an average of 60 seconds which was selected to allow the level crossing barrier down time to be calibrated to observed data. Whilst a southbound train dwells at Darsham Station, the level crossing barrier is closed so the length of train dwell time directly impacts barrier down time Table 6 shows the train services that were included in the model for each time period.

Table 6 – Train Service Frequency per 3hr (AM) and 4hr (PM) period

Service and Direction	6-9 AM	3-7 PM
Lowestoft – Ipswich	4	5
Ipswich - Lowestoft	2	5

4. BASE MODEL CALIBRATION AND VALIDATION

4.1. CRITERIA

4.1.1. The base year scenario was calibrated against traffic flows and queue length data and independently validated against observed journey times to confirm that the model represents current (2015) traffic conditions. Three time periods were selected for validation and calibration: 08:00 – 09:00 (AM peak hour), 15:00 – 16:00 (Inter peak hour) and 17:00 – 18:00 (PM peak hour). The calibration and validation criteria used was based on Department for Transport (DfT) guidelines set out in TAG Unit M3.1 Highway Assignment Modelling.

CALIBRATION

4.1.2. Modelled turning flows at junctions were compared against observed counts using the two criteria set out in Table 7. The first criterion uses differences in flow whilst the second criterion uses the GEH statistic which offers a reliable method of comparing the similarity of two flows irrespective of their magnitude, as shown below.

$$GEH = \sqrt{\frac{(M - C)^2}{(M + C)/2}}$$

where: GEH is the GEH statistic;
M is the modelled flow; and
C is the observed flow.

Table 7 – Traffic Flow Calibration Criteria (source: TAG Unit 3.1)

Table 2 Link Flow and Turning Movement Validation Criteria and Acceptability Guidelines		
Criteria	Description of Criteria	Acceptability Guideline
1	Individual flows within 100 veh/h of counts for flows less than 700 veh/h	> 85% of cases
	Individual flows within 15% of counts for flows from 700 to 2,700 veh/h	> 85% of cases
	Individual flows within 400 veh/h of counts for flows more than 2,700 veh/h	> 85% of cases
2	GEH < 5 for individual flows	> 85% of cases

4.1.3. Observed queue data has also been used to calibrate the model by comparing modelled and observed queues in 5-minute intervals. Queue lengths were measured as the maximum occurring during each 5-minute interval. There are no formal queue length comparison criteria prescribed by industry guidance, but in general the length, variability and profile of modelled queues throughout the hour should be similar to those observed.

VALIDATION

4.1.4. Journey times from the model were compared to observed journey times by way of an independent validation check. The WebTAG criteria set out in Table 8 has been used to assess the model validation.

Table 8 – Journey Time Validation Criteria (source: TAG Unit 3.1)

Table 3 Journey Time Validation Criterion and Acceptability Guideline	
Criteria	Acceptability Guideline
Modelled times along routes should be within 15% of surveyed times (or 1 minute, if higher than 15%)	> 85% of routes

4.2. TRAFFIC FLOW CALIBRATION

4.2.1. Modelled turning flows at each junction were compared against observed turning flows by vehicle type (Car, LGV and HGV) and for all vehicle types combined. As the observed traffic flows were directly input into the model, this check was considered to be calibration rather than an independent validation of the model’s ability to replicate observations. Traffic flow calibration tables are provided in Appendix B for the AM, Inter and PM peak hour models.

AM PEAK HOUR (08:00 – 09:00)

4.2.2. The AM peak hour was found to closely replicate observed turning flows for all vehicle types.

4.2.3. Overall the model slightly over-predicted observed flows (+1.4%) but overall flow totals were within DfT validation criteria (GEH < 5.0) with an average GEH value of 0.2. Table 9 provides a summary of the AM peak hour flow validation against DfT criteria.

Table 9 – AM Peak Hour Turn Flow Validation Summary

	GEH Statistics - AM			Individual Flows		
	GEH < 5	GEH < 6	GEH < 10	f < 700	700 < f < 2700	f > 2700
Car	100.0%	100.0%	100.0%	100.0%	No Data	No Data
LGV	100.0%	100.0%	100.0%	100.0%	No Data	No Data
HGV	100.0%	100.0%	100.0%	100.0%	No Data	No Data
All Veh.	100.0%	100.0%	100.0%	100.0%	No Data	No Data

4.2.4. Figure 5 shows how the modelled and observed turning flows compare and demonstrates that the correlation between the two is strong. The gradient is higher than 1.0 (1.0154) which confirms the slight overestimate of flows. The R² value (0.9996) is very close to 1, which indicates that the modelled flows do correlate with observed flows and confirms that a good level of flow calibration has been achieved.

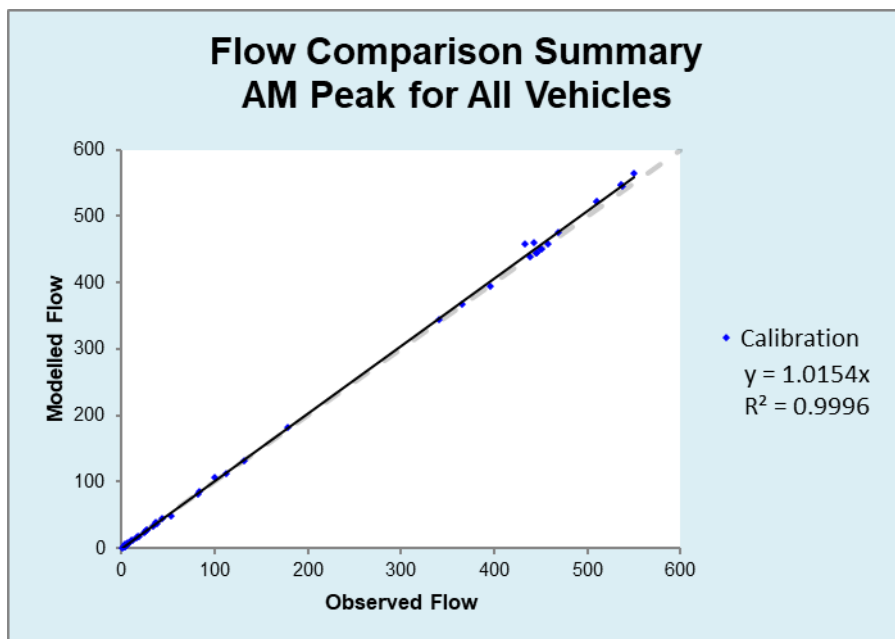

Figure 5 – AM Peak Hour Plot of Modelled vs. Observed Turn Flows

INTER PEAK HOUR (15:00 – 16:00)

4.2.5. The Inter peak hour model replicated observed junction turn flows for all vehicle types in the hour well. Overall the model slightly over-predicted observed flows (+0.3%) but flow totals were within DfT validation criteria (GEH < 5.0) with an average GEH of 0.1. All individual surveyed turn movements met DfT flow validation criteria with a GEH value of less than 5.0. Table 10 provides a summary of the Inter peak hour flow validation against DfT criteria.

Table 10 – Interpeak Hour Turn Flow Validation Summary

	GEH Statistics - IP			Individual Flows		
	GEH < 5	GEH < 6	GEH < 10	f < 700	700 < f < 2700	f > 2700
Car	100.0%	100.0%	100.0%	100.0%	No Data	No Data
LGV	100.0%	100.0%	100.0%	100.0%	No Data	No Data
HGV	100.0%	100.0%	100.0%	100.0%	No Data	No Data
All Veh.	100.0%	100.0%	100.0%	100.0%	No Data	No Data

4.2.6. Figure 6 shows a plot of modelled against observed junction turn flows showing that the correlation between modelled and observed flows was very good. The gradient is more than 1.0 (1.0038) which confirms the slight overestimate of flows. The R² value (0.9998) is very close to 1, showing tight correlation with observed flows.

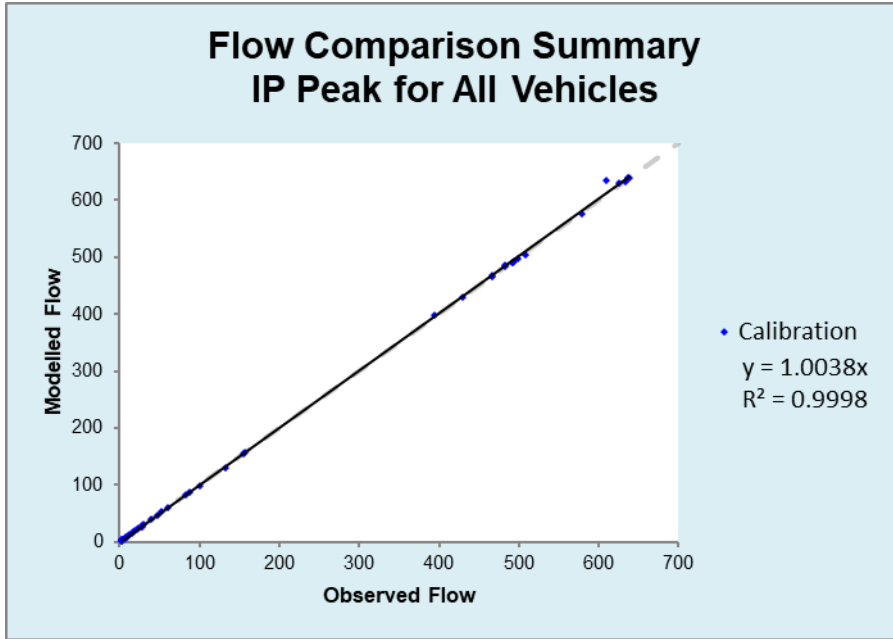

Figure 6 – Inter Peak Hour Plot of Modelled vs. Observed Turn Flows

PM PEAK HOUR (17:00 – 18:00)

4.2.7. The PM peak hour model replicated observed junction turn flows for all vehicles types in the hour very well. Overall the model perfectly predicted observed flows (0.8% difference) with an average GEH of 0.2. All individual surveyed turn movements met DfT flow validation criteria with a GEH value of less than 5.0. Table 11 provides a summary of the PM peak hour flow validation against DfT criteria.

Table 11 – PM Peak Hour Turn Flow Validation Summary

	GEH Statistics - PM			Individual Flows		
	GEH < 5	GEH < 6	GEH < 10	f < 700	700 < f < 2700	f > 2700
Car	100.0%	100.0%	100.0%	100.0%	No Data	No Data
LGV	100.0%	100.0%	100.0%	100.0%	No Data	No Data
HGV	100.0%	100.0%	100.0%	100.0%	No Data	No Data
All Veh.	100.0%	100.0%	100.0%	100.0%	No Data	No Data

4.2.8. Figure 7 shows a plot of modelled against observed junction turn flows showing that the correlation between modelled and observed flows was very good. The gradient is more than 1.0 (1.0086) which confirms the slight overestimate of flows. The R² value (0.9997) is very close to 1, showing tight correlation with observed flows.

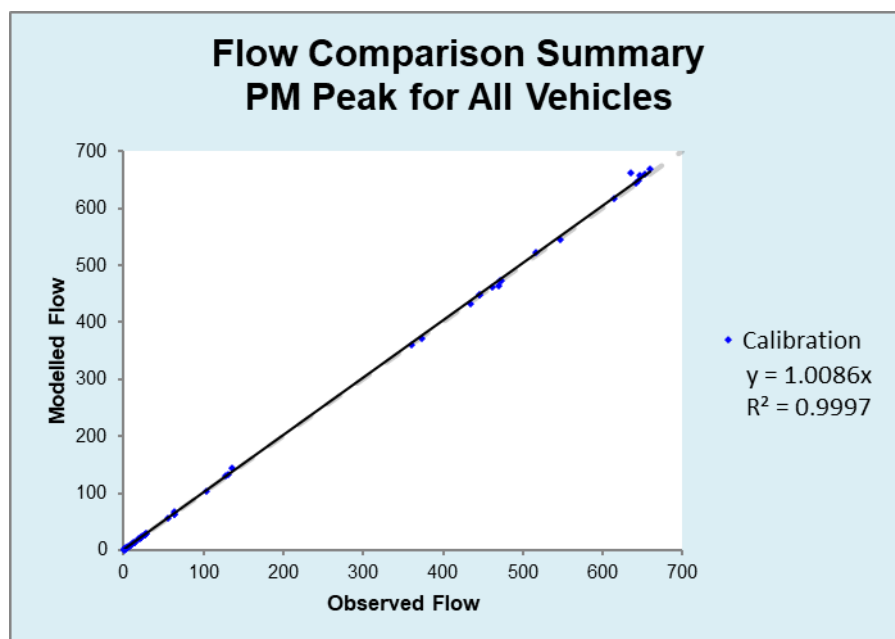

Figure 7 – PM Peak Hour Plot of Modelled vs. Observed Turn Flows

4.3. QUEUE LENGTH CALIBRATION

- 4.3.1. Queue lengths were observed at the eight locations identified in Section 3.2. Queue lengths were also recorded at the two level crossings on the A12 near Darsham and on the B1122 Yoxford Road. Queue length calibration graphs are provided in Appendix B for the AM, Inter and PM peak hours.
- 4.3.2. Observed queue lengths at most of the junctions were very short (typically less than two vehicles). The model was able to replicate this and therefore a more detailed comparison was not made. Slightly longer queues were observed at the following junctions:
- A12 / A1120;
 - A12 / B1122; and
 - A12 / A144.
- 4.3.3. The model showed some variation in queue lengths between iterations and across the peak hours, in line with fluctuations in demand, but the model generally replicated the observed queue lengths very well. At some approaches the model shows a slight over-prediction of queue length, but still within a reasonable range of the observations.

AM PEAK HOUR (08:00 – 09:00)

- 4.3.4. Figure 8 and Figure 9 show the observed and modelled queue lengths at the A12 and B1122 level crossings respectively.

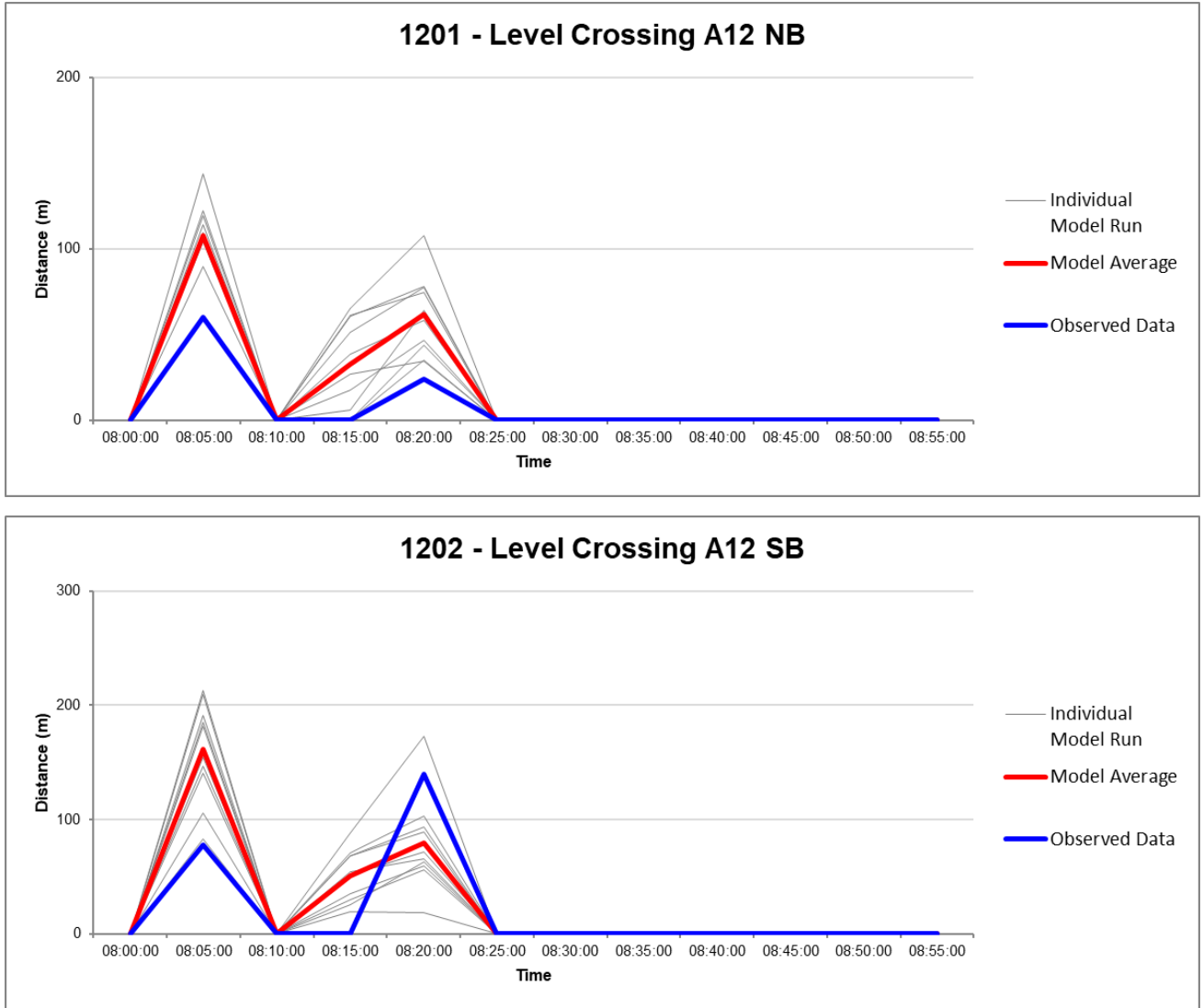

Figure 8 – A12 Level Crossing Queue Length Validation (AM peak)

- 4.3.5. The level crossing on the A12 was closed twice during the AM peak, once at 08:07 for a northbound train and once at 08:21 for a southbound train. This resulted in queues forming northbound and southbound on the A12 at two distinct points in the hour.
- 4.3.6. Queue lengths are highly dependent on the nature of the traffic platoon which arrives when the barrier is closed and so there was significant variability shown in modelled queue lengths across individual model runs. Considering this variability, and the fact that the observed queues represent a single day, modelled and observed queues were shown to be reasonably well matched.

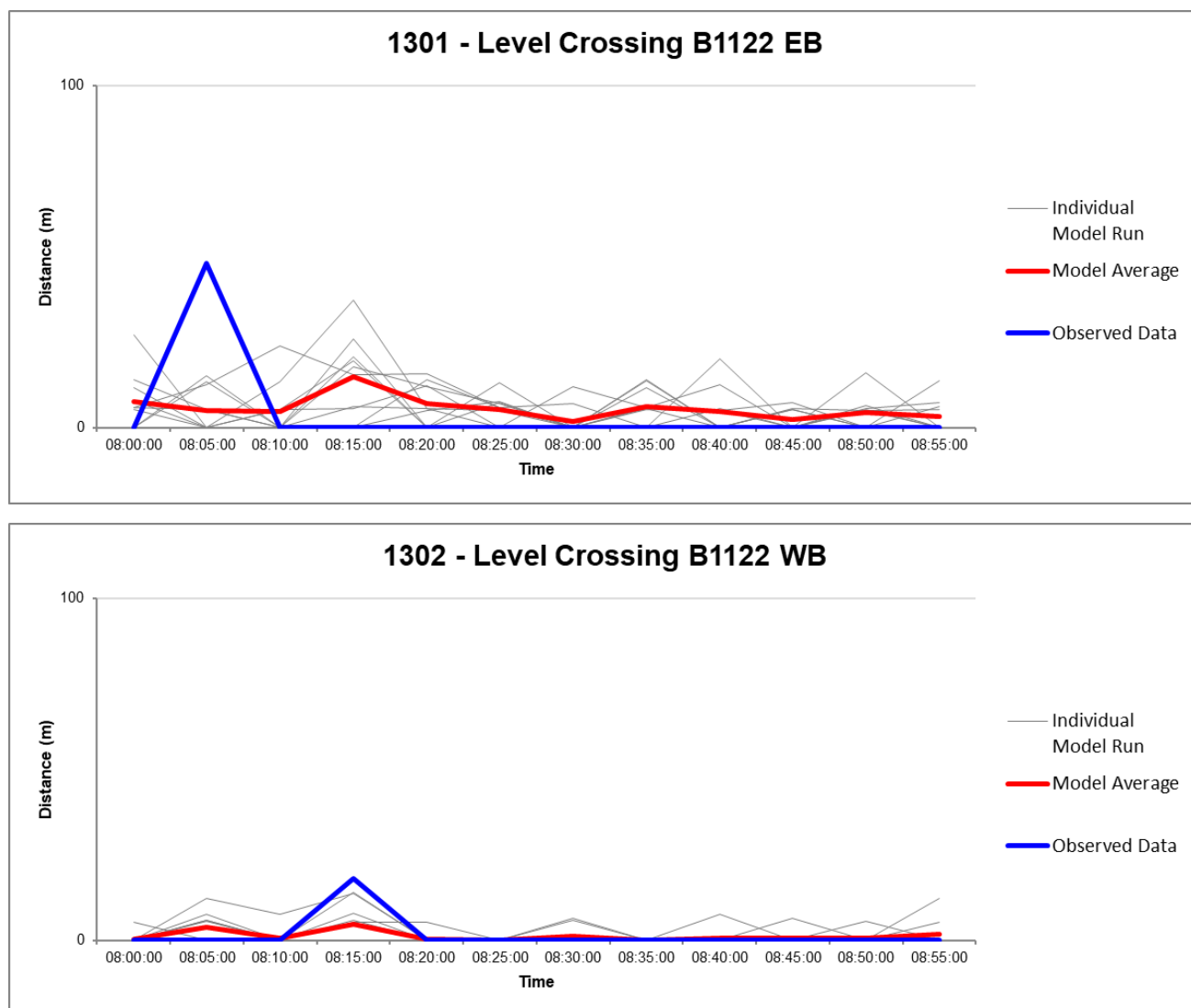

Figure 9 – B1122 Level Crossing Queue Length Validation (AM peak)

- 4.3.7. The B1122 level crossing also closed twice during the AM peak hour and the model accurately reflected the timing and magnitude of observed queues. Traffic flows on the B1122 were much lower than on the A12 and so queue lengths were therefore also much shorter. The similarity of modelled and observed queues were again generally good, considering the variability in traffic platooning and the fact that the queue length survey represents a single day.
- 4.3.8. Overall the model replicated observed queue lengths well in the AM peak hour.

INTER PEAK HOUR (15:00 – 16:00)

- 4.3.9. Figure 10 and Figure 11 show the observed and modelled queue lengths in the Inter peak hour at the A12 and B1122 level crossings respectively.

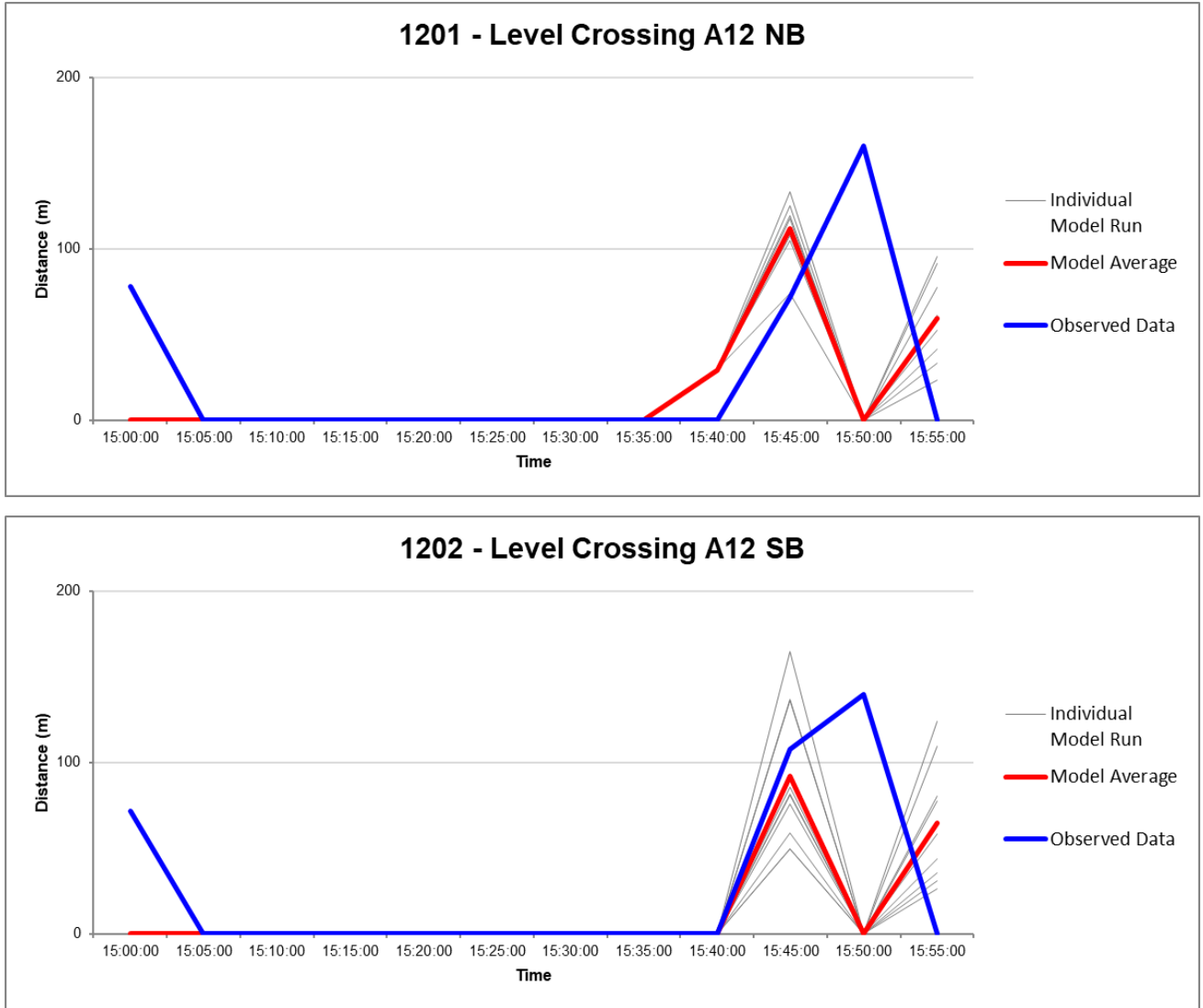

Figure 10 – A12 Level Crossing Queue Length Validation (Inter peak)

4.3.10. The level crossing on the A12 was recorded as closing three times during the Inter peak hour; at 15:00 and 16:00 for northbound trains, and once at 15:49 for a southbound train. There was a slight time offset between the observed closures and the scheduled train timetable which informs the modelled trains and this difference is therefore reflected in the graph. However, the magnitude of queue lengths reported from the model still match observed queue lengths on the A12.

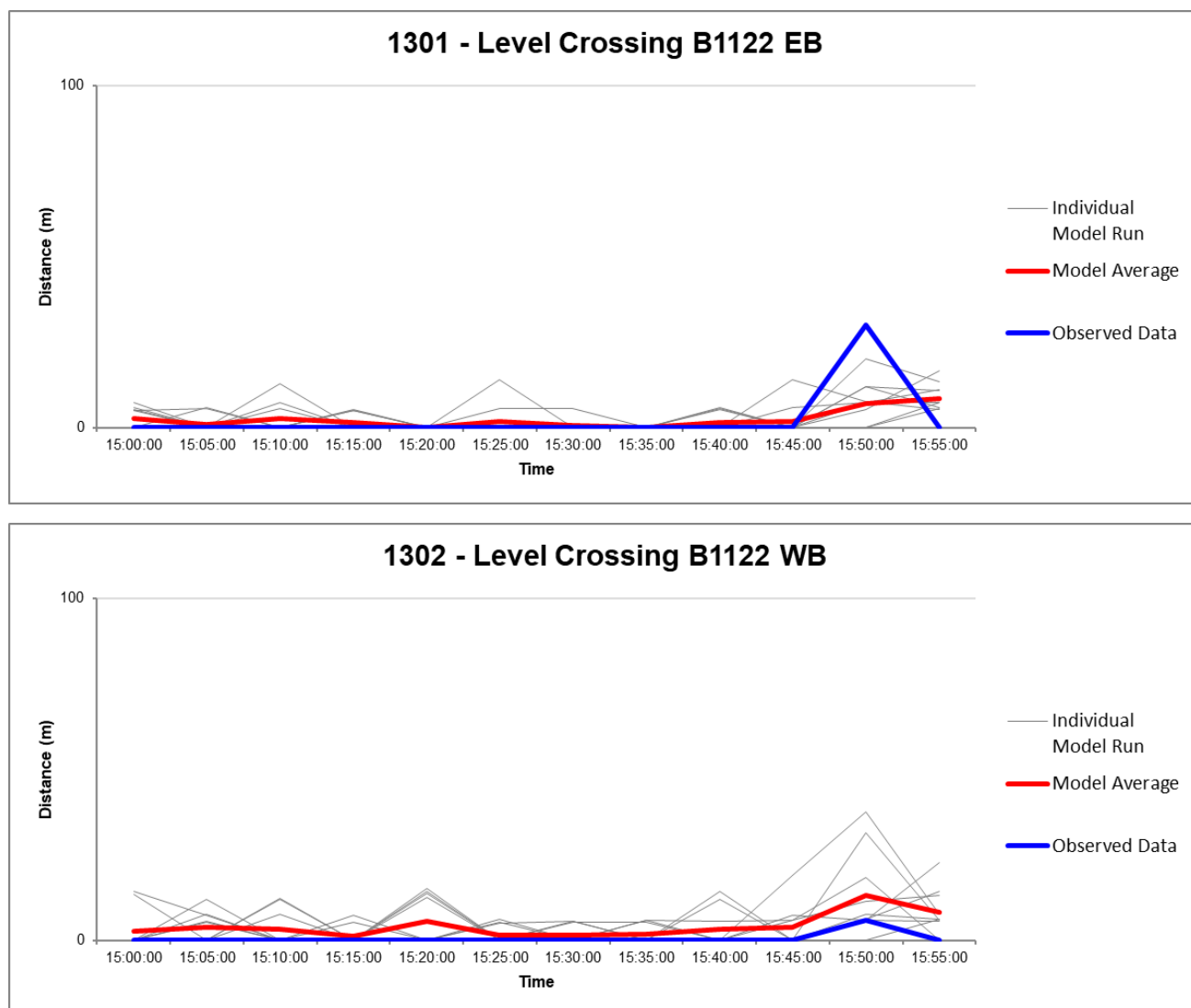

Figure 11 – B1122 Level Crossing Queue Length Validation (Inter peak)

- 4.3.11. Modelled queue lengths at the level crossing on the B1122 were much shorter than on the A12 and matched the observed queue profile. The eastbound modelled queue was shorter than that observed, but this is thought to be due to the nature of the platoon arrival when the barrier was down and the fact that the queue length survey was carried out on one day only.
- 4.3.12. Overall the model replicated observed queue lengths well in the Inter peak hour.

PM PEAK HOUR (17:00 – 18:00)

- 4.3.13. Figure 12 and Figure 13 show the observed and modelled queue lengths at the A12 and B1122 level crossings respectively.

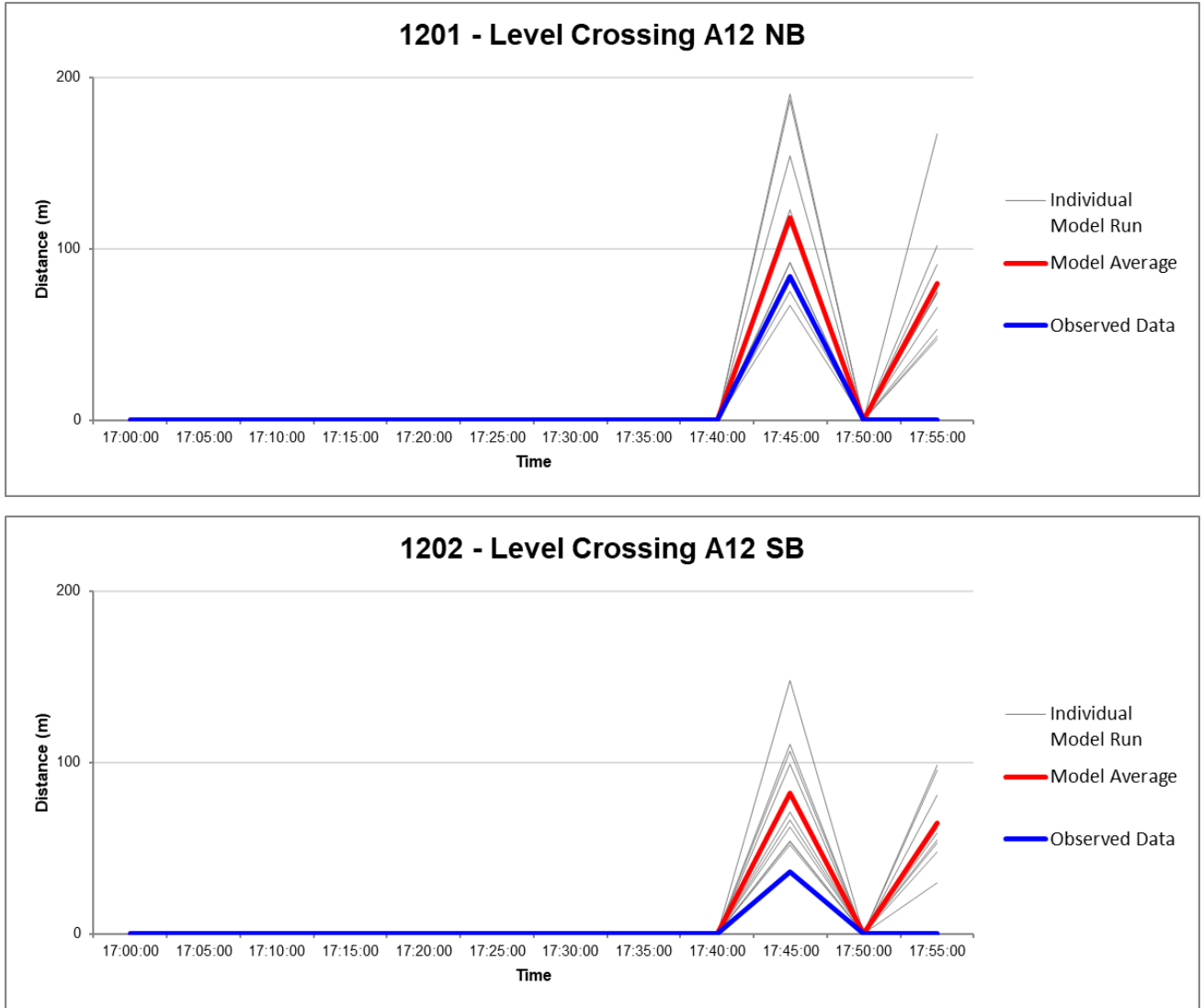

Figure 12 – A12 Level Crossing Queue Length Validation (PM peak)

4.3.14. The level crossing on the A12 closed twice during the PM peak, once at 17:49 for a southbound train and once at 18:00 for a northbound train. This resulted in queues forming northbound and southbound on the A12 at two distinct points in the hour. Overall queue lengths matched observed reasonably well.

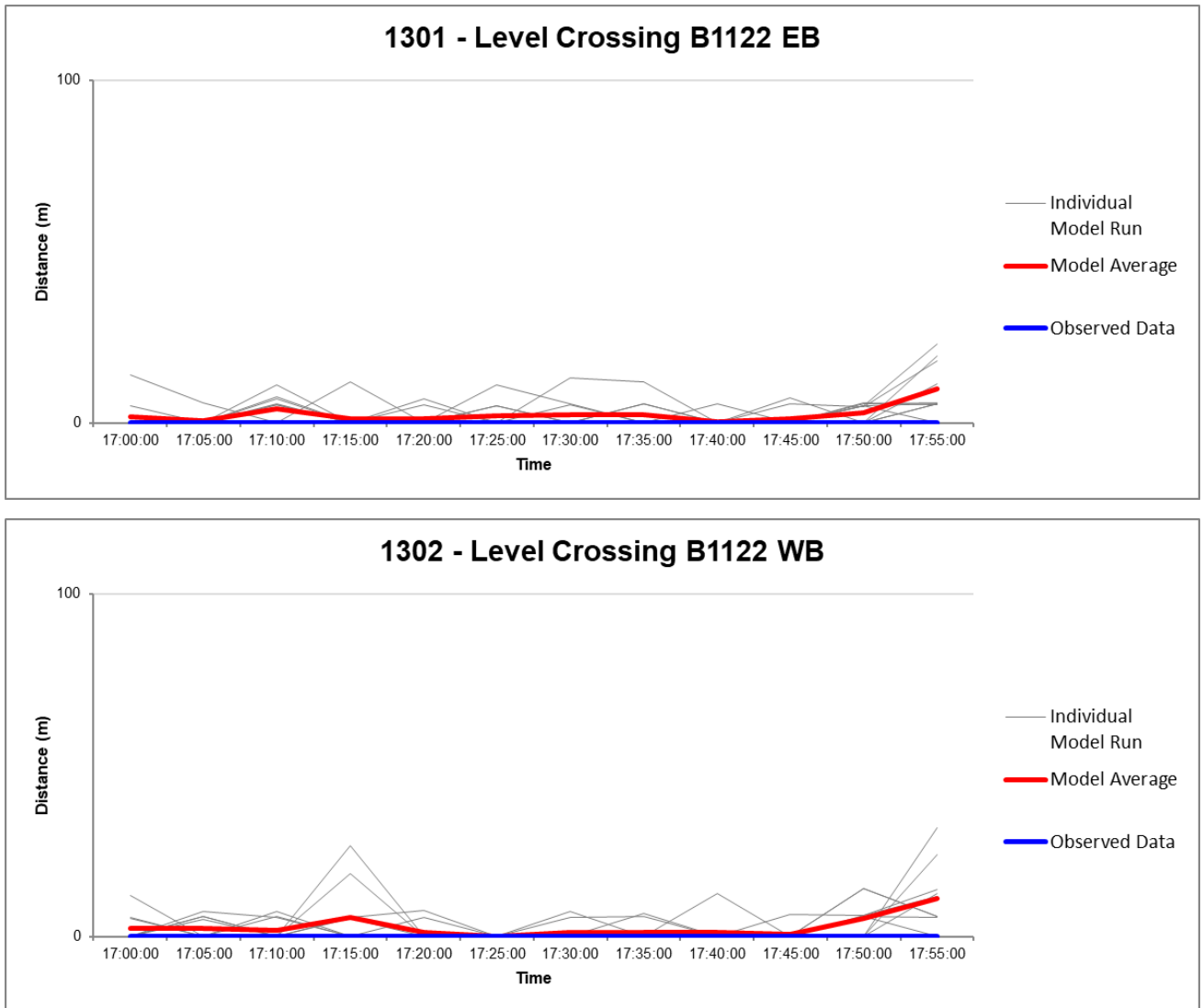

Figure 13 – B1122 Level Crossing Queue Length Validation (PM peak)

4.3.15. Queues at the level crossing on the B1122 were very small in the PM peak hour as reflected in the model. Overall the model replicated observed queue lengths well in the PM peak hour.

4.4. JOURNEY TIME VALIDATION

4.4.1. Journey time validation tables and graphs are provided in Appendix B for the AM, Inter and PM peak hours.

AM PEAK HOUR (08:00 – 09:00)

4.4.2. Modelled northbound and southbound A12 journey times matched AM peak hour observed journey times well along the full route. Table 12 shows the observed average and modelled journey times on the A12 for each recorded section. There were small differences along individual segments, but overall the model showed a good fit. Figure 14 shows the modelled and observed journey times for each segment.

Table 12 – AM Peak Hour Observed and Modelled Journey Times

Route:	Observed (S)	Modelled (S)	Diff (S)	Diff (%)	Distance (m)	WebTAG Criteria
1 - Section 1 NB	14	14	0	2.9%	185	PASS
2 - Section 2 NB	60	68	8	13.3%	1115	PASS
3 - Section 3 NB	68	68	-1	-0.9%	1055	PASS
4 - Section 4 NB	52	54	1	2.9%	1062	PASS
5 - Section 4 SB	48	54	7	14.1%	1066	PASS
6 - Section 3 SB	66	71	5	8.2%	1074	PASS
7 - Section 2 SB	61	68	7	11.4%	1097	PASS
8 - Section 1 SB	13	16	3	24.7%	190	PASS

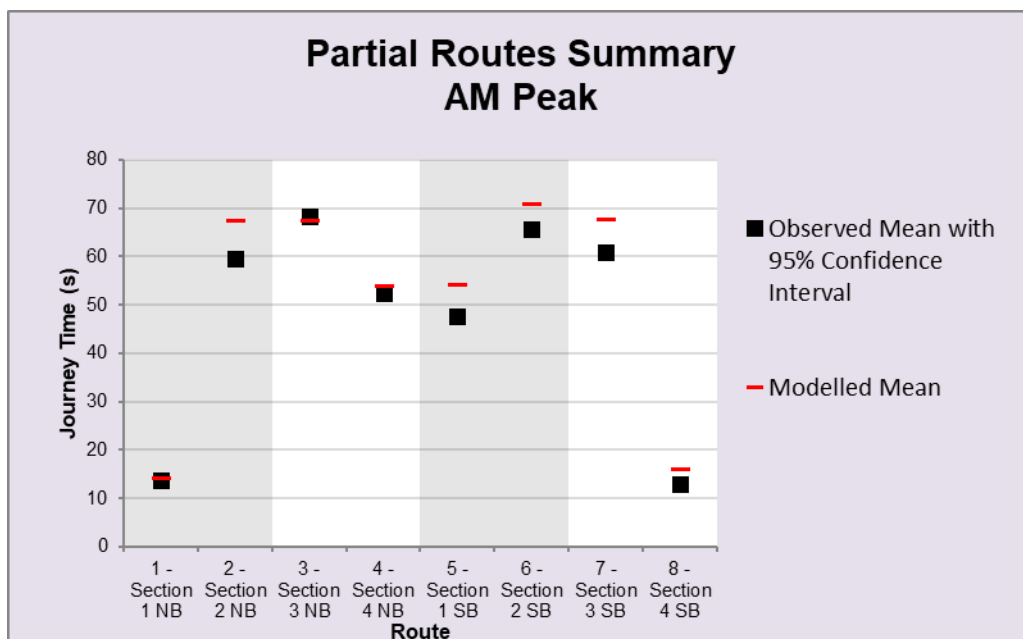

Figure 14 – AM Peak Hour Journey Time Segments

4.4.3. Figure 15 and Figure 16 show the cumulative journey times in the northbound and southbound directions respectively. Cumulative journey times were shown to be within DfT criteria ($\pm 15\%$) in both directions.

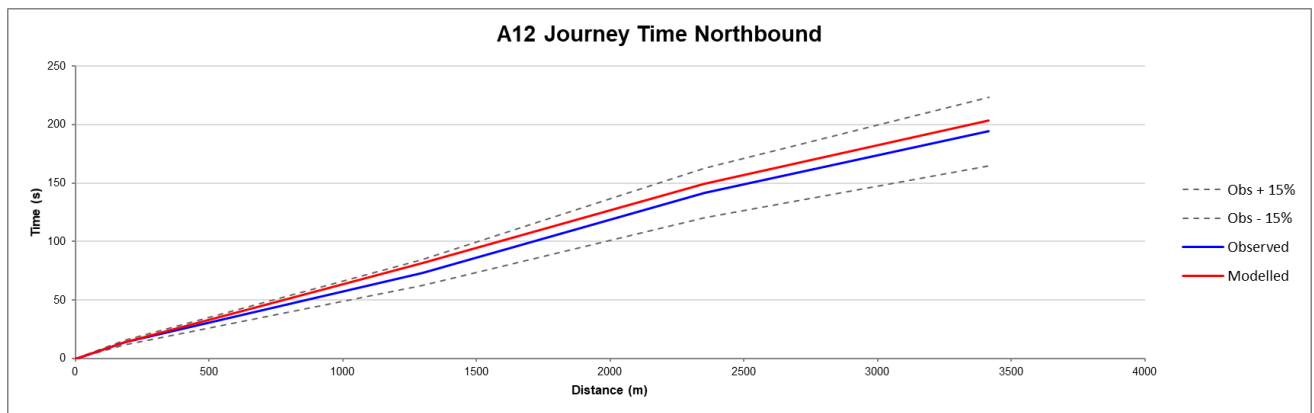

Figure 15 – AM Peak Hour Journey Time Northbound

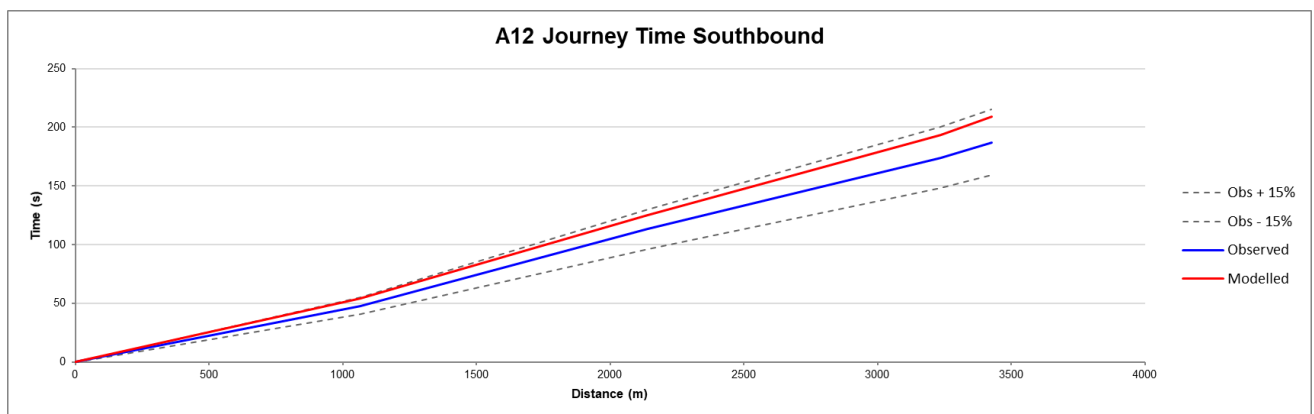

Figure 16 – AM Peak Hour Journey Time Southbound

INTER PEAK HOUR (15:00 – 16:00)

4.4.4. Modelled northbound and southbound A12 journey times matched Inter peak hour observed journey times well along the full route. Table 13 shows the observed average and modelled journey times on the A12 for each recorded section. There were small differences along individual segments, but overall the model showed a good fit. Figure 17 shows the modelled and observed journey times for each segment.

Table 13 – Inter Peak Hour Observed and Modelled Journey Times

Route:	Observed (S)	Modelled (S)	Diff (S)	Diff (%)	Distance (m)	WebTAG Criteria
1 - Section 1 NB	13	14	1	9.4%	185	PASS
2 - Section 2 NB	58	68	10	16.4%	1115	PASS
3 - Section 3 NB	72	67	-5	-6.7%	1055	PASS
4 - Section 4 NB	60	55	-6	-9.5%	1062	PASS
5 - Section 4 SB	51	54	3	5.7%	1066	PASS
6 - Section 3 SB	85	69	-16	-19.1%	1074	PASS
7 - Section 2 SB	62	67	5	8.7%	1097	PASS
8 - Section 1 SB	23	18	-6	-24.8%	190	PASS

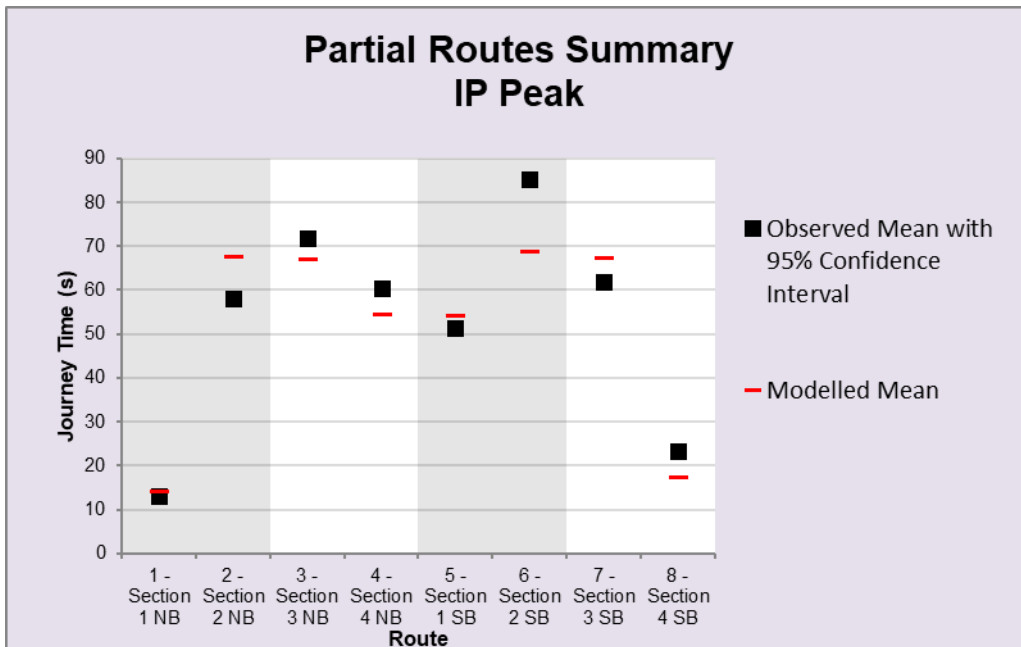

Figure 17 – Inter Peak Hour Journey Time Segments

4.4.5. Figure 18 and Figure 19 show the cumulative journey times in the northbound and southbound directions respectively. Cumulative journey times were shown to be within DfT criteria ($\pm 15\%$) in both directions.

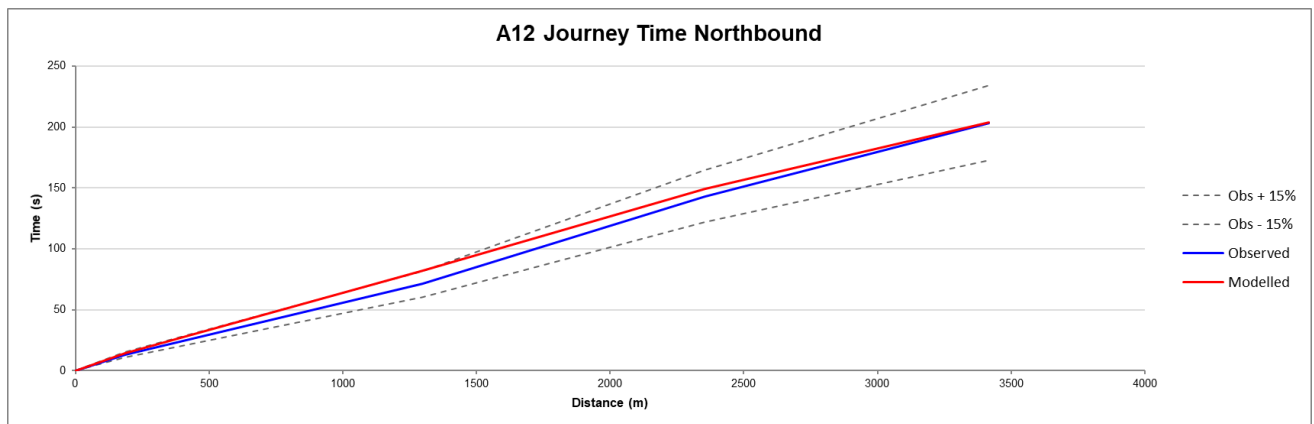

Figure 18 – Inter Peak Hour Journey Time Northbound



Figure 19 – Inter Peak Hour Journey Time Southbound

PM PEAK HOUR (17:00 – 18:00)

4.4.6. Modelled northbound and southbound A12 journey times matched PM peak observed journey times well along the full route. Table 14 shows the observed average and modelled journey times on the A12 for each recorded section. There were small differences along individual segments, but overall the model showed a good fit. Figure 20 shows the modelled and observed journey times for each segment.

Table 14 – PM Peak Hour Observed and Modelled Journey Times

Route:	Observed (S)	Modelled (S)	Diff (S)	Diff (%)	Distance (m)	WebTAG Criteria
1 - Section 1 NB	16	14	-2	-12.2%	185	PASS
2 - Section 2 NB	57	68	11	19.3%	1115	PASS
3 - Section 3 NB	67	67	-1	-1.1%	1054	PASS
4 - Section 4 NB	48	54	6	13.2%	1064	PASS
5 - Section 4 SB	49	53	4	9.0%	1066	PASS
6 - Section 3 SB	72	69	-3	-3.9%	1053	PASS
7 - Section 2 SB	62	67	6	9.2%	1117	PASS
8 - Section 1 SB	15	17	2	16.0%	190	PASS

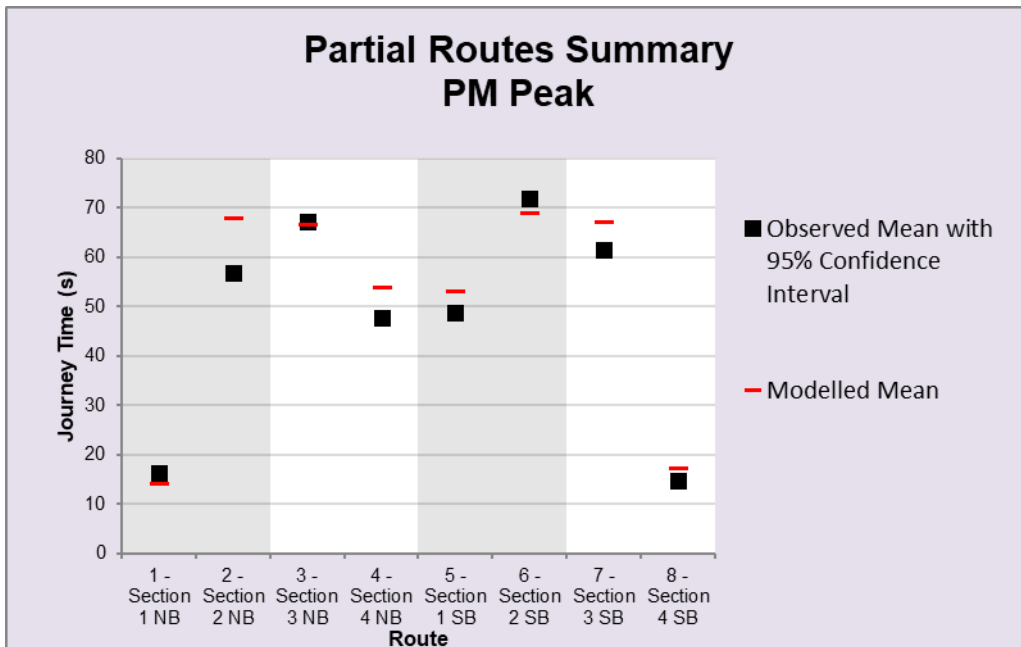

Figure 20 – PM Peak Hour Journey Time Segments

4.4.7. Figure 21 and Figure 22 show the cumulative journey times in the northbound and southbound directions respectively. Cumulative journey times were shown to be within DfT criteria (+/- 15%) in both directions.

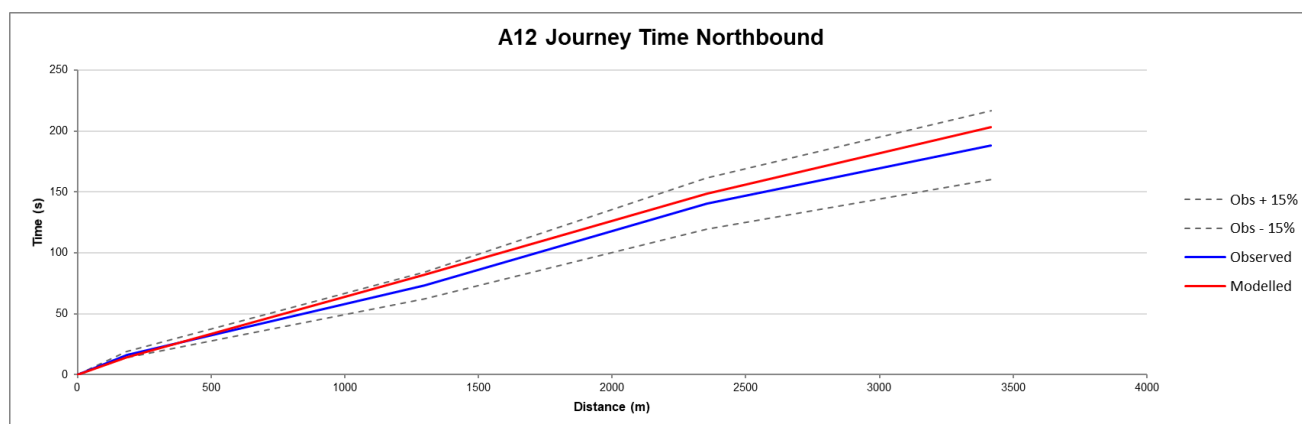

Figure 21 – PM Peak Hour Journey Time Northbound

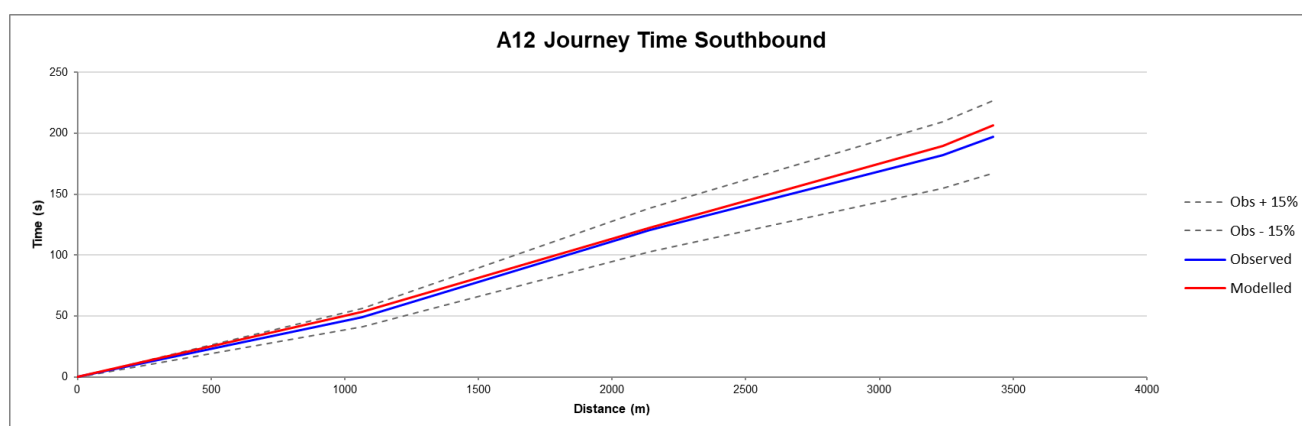

Figure 22 – PM Peak Hour Journey Time Southbound

4.5. SUMMARY OF MODEL CALIBRATION AND VALIDATION

- 4.5.1. Modelled traffic flows at junctions were shown to match observed turn flows very well across the modelled network. Overall modelled junction flows were slightly higher than observed (+0.8%) but met DfT turn flow criteria in all three peak hours.
- 4.5.2. At some locations the model predicted that there would be significant variability between individual simulation runs and in some cases this leads to a discrepancy between observed and modelled queue lengths. However, comparison of the observed and modelled queue lengths across the hour confirmed that the model was generally able to replicate the location, length and time of queues well across the modelled network.
- 4.5.3. Observed journey times northbound and southbound on the A12 were replicated well by the model meeting DfT criteria (within +/- 15%) during all peak hours. Journey times for individual segments were also compared to confirm that delays were in the correct locations along the full route.

5. FORECAST SCENARIO – 2023 EARLY YEARS

5.1. SCENARIO ASSUMPTIONS

- 5.1.1. 2023 represents the 'Early Years' stage of the construction of Sizewell C. During this year, an initial workforce of 1,500 workers is forecast to be deployed at Sizewell C construction site. From this amount, 600 will be residing in 400 caravans at land east of Eastlands Industrial Estate (LEEIE) and the remaining workers with journey origins as per the gravity model.
- 5.1.2. Whilst 2023 does not represent the full demand in terms of the number of workers, it does represent a scenario where the workforce has begun to arrive but most mitigation is yet to be provided. It is important to test 2023 to establish the level of impact that may occur whilst the mitigation schemes are being built and therefore not yet providing their intended relief.
- 5.1.3. In addition to the 1,500 main site construction workers, a further 730 workers are estimated to be deployed to construct the Additional Development (AD) sites as follows:
- 100 workers at Two Village bypass construction site;
 - 300 workers at Sizewell Link Road construction site;
 - 100 workers at northern park & ride construction site;
 - 100 workers at southern park & ride construction site;
 - 30 workers at A12/B1122 Yoxford roundabout construction site; and
 - 100 workers at the Freight Management Facility.
- 5.1.4. It is assumed that workers at the A12/B1122 roundabout construction site will park at the northern P&R construction site, and a shuttle bus service will transport workers between the two sites.
- 5.1.5. All these construction sites have their associated HGV deliveries per day, travelling along the A12 from the north and south on fixed routes, as follows:
- SZC main development site – 300 HGVs each way;
 - Two Village bypass construction – 60 HGVs each way;
 - Sizewell Link Road construction – 100 HGVs each way;
 - Northern park & ride construction – 21 HGVs each way;
 - Southern park & ride construction – 21 HGVs each way; and
 - A12/B1122 Yoxford roundabout construction – 10 HGVs each way.
- 5.1.6. It is also assumed that HGVs to the main SZC site will use the B1122. The proposed HGV delivery profile across the day, at all sites, is shown in Figure 23 below.

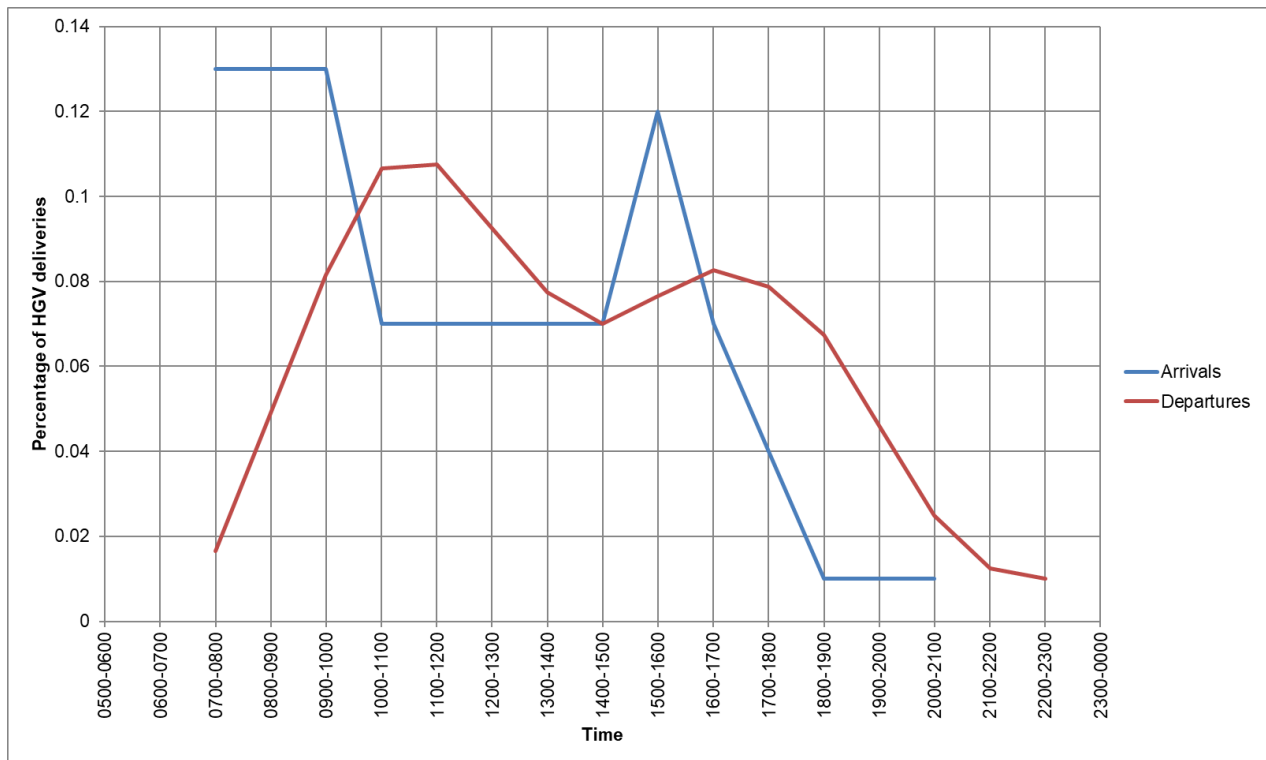

Figure 23 – Proposed HGV delivery profile

TRANSPORT NETWORK ASSUMPTIONS

5.1.7. The transport network being used in the 2023 model scenarios remains similar to that used in the base year, with no embedded mitigation assumed to be completed. The only network changes included in the ‘with development’ models are the provision of a number of accesses to serve the different construction sites in the study area.

Figure 24 shows the access to the A12 / B1122 roundabout construction site. A temporary bus stop and HGV deliveries access has been placed east of the junction, accessed from the B1122. This bus stop is provided to facilitate the shuttle bus service moving construction workers from the temporary northern park & ride to the A12 / B1122 site. Detailed planning of how this construction site will operate bus drop offs and deliveries is yet to be undertaken so these assumptions have been made within the model to allow the estimated bus and HGV trips to be accommodated. The locations and operation of these facilities will be better defined at a later stage of planning and the assumptions used within the modelling do not represent a preferred location or an indication of the site management strategy.



Figure 24 – Temporary bus stop and HGV delivery access at Yoxford junction

5.1.8. As the northern park & ride and associated access roundabout on the A12 are likely to be under construction by 2023, a temporary access has been included in the 2022 Early Years network. Figure 25 shows the temporary access to the northern park & ride construction site, modelled as a simple T junction on Willow Marsh Lane. As with the A12 / B1122 construction site, a detailed site operation plan is not yet available so an assumption was made about how access to the construction site might be made in 2023.



Figure 25 – Northern P&R site access

TRAFFIC DEMAND ASSUMPTIONS - 2023

5.1.9. Two new layers of traffic demand were included in the forecast year scenarios; ‘Growth traffic’ and ‘Sizewell C traffic’. The number of vehicle types in the model therefore increases from five in the base year to twelve in the 2023, 2028 and 2034 scenarios, as listed below:

- Car (100), **Car Growth (101)**, **Car SZC (102)**;
- LGV (700), **LGV Growth (701)**, **LGV SZC (702)**;
- HGV (200), **HGV Growth (201)**, **HGV SZC (202)**;
- Bus (300), **Bus SZC (302)**; and
- Train (400).

5.1.10. Traffic flows were extracted from the strategic VISUM model described in Section 1.2. A subnetwork of each VISUM model (one for each hour) was created for the study area which allowed origin-destination matrices to be extracted. Figure 26 shows the extent of the VISUM subnetwork.

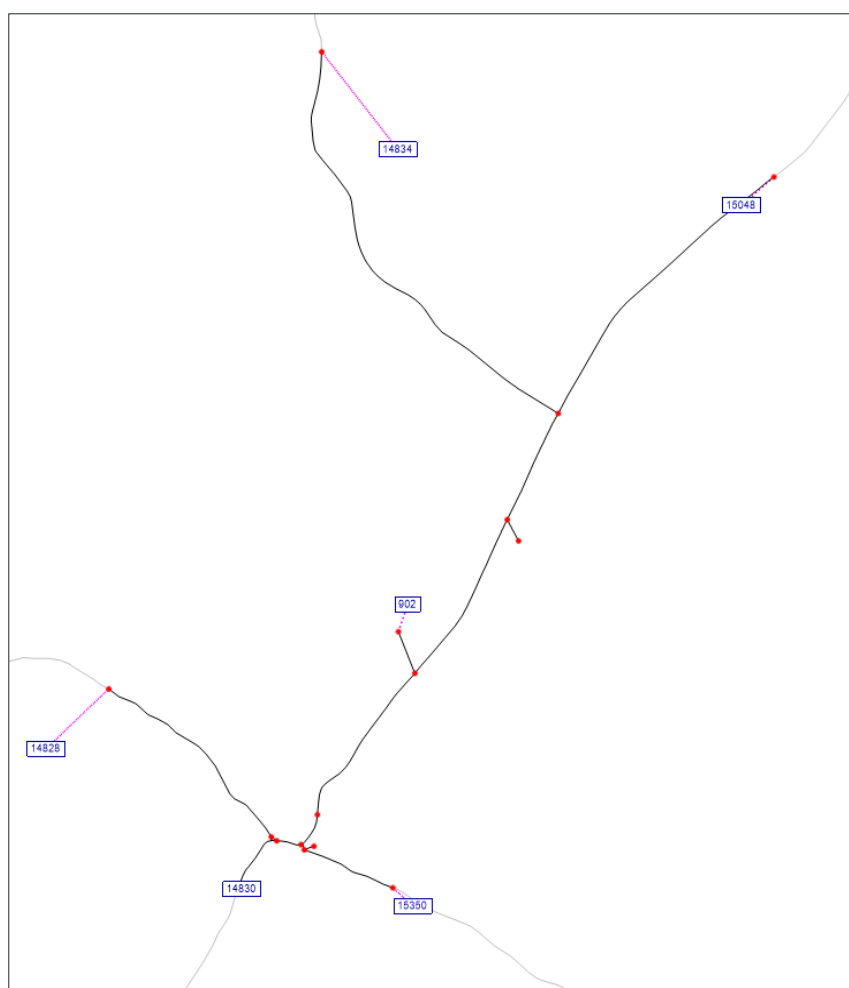

Figure 26 – VISUM subnetwork in the modelled area

5.1.11. A total of seven zones are included in the VISUM sub-network, connected on to the A12 South, A1120, B1122, P&R access, The Street, A144 and A12 North. For the purposes of this report, these zones are classified as major roads, whilst additional zones within the study area that are not

included in the VISUM model have been termed ‘minor roads’. A list of the roads deemed minor and major is provided in Table 15.

Table 15 – Major and minor road classification

	Demand Category
Major Roads (included in VISSIM and VISUM)	<ul style="list-style-type: none"> • A12 South • A1120 • B1122 • P&R access • The Street • A144 • A12 North
Minor Roads (included in VISSIM but <u>not</u> in VISUM)	<ul style="list-style-type: none"> • Lymballs Lane • Willow Marsh Lane • Darsham Service Station • Westleton Road

5.1.12. The VISUM model contains the following matrices:

- Car (base + growth);
- LGV (base + growth);
- HGV (base + growth);
- Car SZC: car trips associated with Sizewell C;
- LGV SZC: LGV trips associated with Sizewell C; and
- Car SZB RF: car trips associated with Sizewell B Relocation Facility.

VISSIM Matrices

5.1.13. The VISUM models have been used to generate the VISSIM forecast matrices, which build on top of the base year matrices obtained from observed data. As the VISUM models do not separate base and growth traffic in the forecast scenarios, the VISUM base year flows have been subtracted from the forecast year flows to calculate the ‘major road’ growth flows. This method resulted in a small number of negative values where the base flows were slightly higher than the forecast flows. These negative values have been subtracted from the base year matrices. The hourly origin-destination growth matrices have been converted into 15-minute matrices by using the base year profiles.

5.1.14. Growth on ‘minor road’ flows were estimated by applying a TEMPro growth factor (NTEM¹ dataset 7.2) to the observed base flows on these roads.

¹ National Trip-End Model

- 5.1.15. The ‘minor road’ and ‘major road’ growth flows were put together to create 11x11 matrices to cover the whole VISSIM study area. These have been input into the VISSIM model as the “Growth” matrices for each 15- minute period.
- 5.1.16. The Sizewell C construction worker private car traffic was extracted from the 2023 Early Years VISUM model which assumed a total construction workforce of 1,500 workers at Sizewell C, plus an additional 730 workers on Associated Development sites. The SZC construction traffic assigned in VISSIM matrices is formed of worker private car movements to and from:
- Northern Park & Ride site;
 - Sizewell C construction site;
 - Sizewell Link Road and Two Village bypass construction sites (A12 south); and
 - Non-work trips made by non-home based workers when they are not on shift.
- 5.1.17. The hourly Sizewell C workers flows have been converted to 15-minute flows using the shift pattern profile developed from entry and exit data gathered at Hinkley Power Station. Full details of this process are included in TN01 – SZC Worker Profiling in Appendix G.
- 5.1.18. The Sizewell C LGV flows are associated with other service vehicles to and from the site. These are not expected to be subject to the Sizewell shift pattern so have been kept separate in the VISSIM model with a 1-hour profile.
- 5.1.19. Table 16 provides a summary of the different layers of traffic input and how they have been incorporated into the model.

Table 16 – 2023 Demand input sources

	Major to Major	Major to Minor	Minor to Major	Minor to Minor
Base flows	Observed data (15-minute)	Observed data (15-minute)	Observed data (15-minute)	Observed data (15-minute)
Growth flows	Calculated from VISUM matrices (15-minute)	Growth factor applied to observed data (15-minute)	Growth factor applied to observed data (15-minute)	Growth factor applied to observed data (15-minute)
Sizewell C flows	SZC Car VISUM matrices (15-minute) SZC LGV VISUM matrices (1-hour)			

- 5.1.20. Table 17 and Table 18 show the total demand for the model by hourly time period for the Reference Case and Early Years scenarios respectively.

Table 17 – 2023 Network Traffic Reference Case (in vehicles per hour)

	6–7 am	7–8 am	8–9 am	3-4 pm	4-5 pm	5-6 pm	6-7 pm
Base 2023	515	1,172	1,378	1,543	1,601	1,465	1,086
Background Growth	178	169	120	142	127	147	207

Sizewell C	-	-	-	-	-	-	-
Total	693	1,341	1,497	1,685	1,728	1,612	1,293

Table 18 – 2023 Network Traffic Early Years (in vehicles per hour)

	6–7 am	7–8 am	8–9 am	3-4 pm	4-5 pm	5-6 pm	6-7 pm
Base 2023	515	1,165	1,377	1,542	1,593	1,459	1,084
Background Growth	178	160	111	122	124	139	204
Sizewell C	92	314	63	27	52	244	166
Total	785	1,639	1,551	1,691	1,769	1,842	1,455

Sizewell C Bus services and HGV deliveries

5.1.21. In addition to the private worker traffic input as matrices in the model, there are other vehicle movements associated with Sizewell C:

- Buses shuttling workers between northern park & ride site and A12/B1122 Yoxford roundabout construction site.
- HGVs delivering construction materials and plant movements to and from:
 - Sizewell C construction site;
 - Northern park & ride site;
 - Southern park & ride site;
 - A12/B1122 Yoxford junction;
 - Two Village bypass; and
 - Sizewell Link Road.

5.1.22. Table 19 details the Sizewell bus services for 2023. As the park and ride sites are still under construction in 2023, the bus services are limited to a small number of services from the northern park and ride site towards the A12/B1122 Yoxford junction in the AM period and the reverse direction in the PM period. Bus services were coded into VISSIM as Public Transport Lines with fixed routes, departing from the temporary northern park and ride site and making a 5-minute drop-off stop at A12/B1122 Yoxford junction before returning to the northern park and ride site.

Table 19 – 2023 Early Years Sizewell Bus services

Service	Direction	6-7 am	7-8 am	8-9 am	3-4 pm	4-5 pm	5-6 pm	6-7 pm
Northern park and ride site to A12 / B1122 construction site	Southbound	0	2	0	0	0	0	0
	Northbound	0	0	0	0	0	2	0
Total		0	2	0	0	0	2	0

5.1.23. Table 20 shows the HGV deliveries to Sizewell C construction site as well as the deliveries to the associated development sites for each hour. These HGVs were modelled as vehicle type “202:

HGV SZC” and are assigned to Public Transport Lines with fixed routes and equally spaced departure times.

Table 20 – 2023 Early Years HGV deliveries

Delivery Site	Direction	6-7 am	7-8 am	8-9 am	3-4 pm	4-5 pm	5-6 pm	6-7 pm
Sizewell C	Inbound	14	31	31	23	13	7	2
	Outbound	0	1	9	17	19	20	18
Northern park & ride	Inbound	1	3	3	2	1	0	1
	Outbound	0	0	1	1	2	2	1
Southern park & ride	Inbound	0	1	0	1	0	0	0
	Outbound	0	0	0	0	1	0	0
Yoxford Junction	Inbound	1	1	1	1	1	0	0
	Outbound	0	0	0	1	0	1	1
Two Village bypass	Inbound	0	2	1	1	1	0	0
	Outbound	0	0	0	0	1	0	1
Sizewell Link Road	Inbound	1	2	2	1	1	1	0
	Outbound	0	0	1	1	1	1	1
Total		17	41	49	49	41	32	25

5.2. SCENARIO PERFORMANCE COMPARISON

5.2.1. This section presents the performance comparison between the validated base year scenario (“2015”), the Reference Case scenario for 2023 (“2023 RC”), and the 2023 Early Years scenario (“2023 EY”) with Sizewell C construction traffic.

NETWORK-WIDE PERFORMANCE

5.2.2. Table 21 provides a number of network-wide statistics that were extracted from the three different VISSIM scenarios.

Table 21 – Network Performance Model Results

Overall Network Statistics	AM (6-9am)			PM (3-7pm)		
	2015	2023 RC	2023 EY	2015	2023 RC	2023 EY
Total Time Taken (h)	275	323	370	499	599	611
Total Distance (km)	17,193	19,961	22,489	31,021	34,406	37,033
Total Vehicles	3,124	3,602	4,159	5,858	6,505	7,102
Total Delay (h)	24	30	38	46	54	65
Avg. Time (s) / Vehicle	317	322	320	307	309	310
Avg. Time (s) / Mile	93	94	95	93	94	96
Avg. Distance (m) / Vehicle	5,504	5,542	5,407	5,295	5,289	5,214
Avg. Speed (mph)	39	38	38	39	38	38
Avg. Speed (kph)	63	62	61	62	62	61
Avg. Delay / Vehicle (s)	28	30	33	28	30	33

- 5.2.3. During the AM and PM peaks, the network-wide statistics show that time, distance and delay have a linear relationship with the number of vehicles in the network. The extra vehicles generated by Sizewell C do not cause a significant increase in the time, distance or delay per vehicle compared to the Reference Case scenario and impact is therefore minimal.
- 5.2.4. Reviewing the relative statistics, it is possible to observe that there is little variation between the different scenarios. For example, the VISSIM model predicts that the average driver will experience a 3 second (+10.0%) increase in delay in 2023 Early Year compared to the Reference Case in both the AM and PM periods. The average speed in the network remains almost the same across all the scenarios. The VISSIM model is sensitive to differences in scenarios so minor changes in delay should not be interpreted as a difference in performance and should instead be viewed as no change.
- 5.2.5. Figure 27 shows the average journey time along the A12 for each scenario. The graph demonstrates that the journey times along the main road show very little change for either direction or time period.

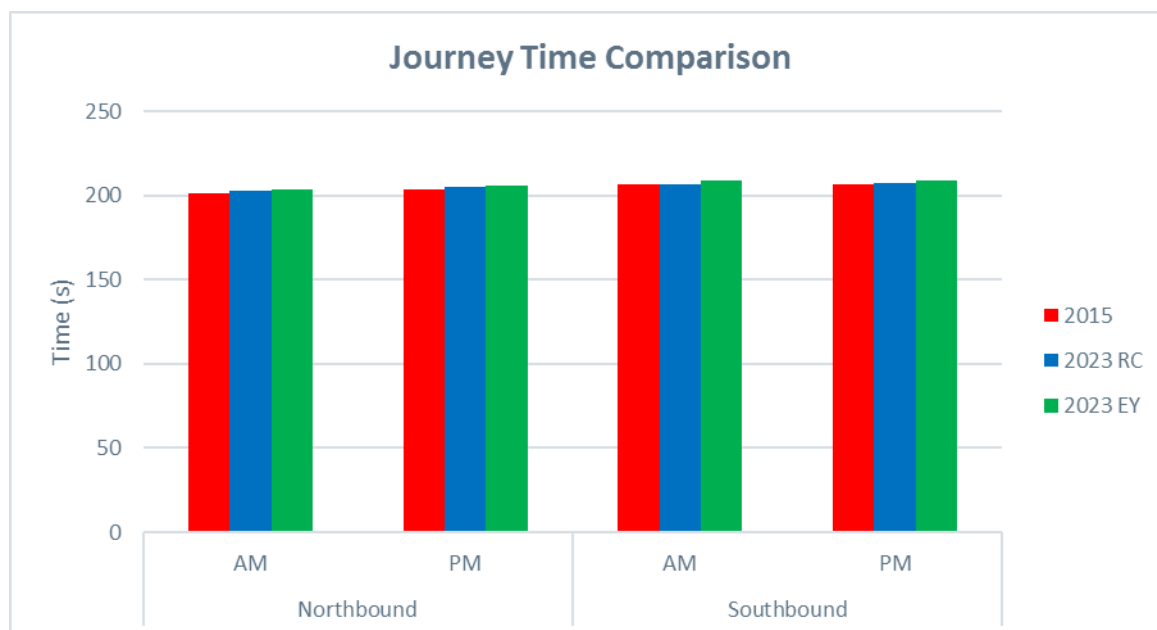

Figure 27 – 2023 A12 Journey Time comparison

- 5.2.6. Overall the network-wide statistics show that the impact felt by the average driver as a result of the Sizewell C Early Years construction traffic will be negligible both in the AM and PM periods.

JUNCTION PERFORMANCE

- 5.2.7. Queue and average delay results have been collected for all junctions in the model in order to assess the performance of each junction.
- 5.2.8. Figure 28 shows the average delay for each junction over the whole AM and PM periods. The values shown below represent the average of all turning movements in the junction.
- 5.2.9. The graphs show that the level of delay is very low at the A12 junctions with Westleton Road, Darsham Petrol Station, The Street, Willow Marsh Lane and Lymballs Lane. A higher level of delay is observed at the A12 / A1120, A12 / B1122 and A12 / A144 junctions. The addition of Sizewell construction traffic increases delays by an average of 1 to 2 seconds per vehicle at the A12 / B1122 junction during the AM and PM periods and by approximately 2 second at the A12 / A144 junction during the AM period.
- 5.2.10. A more detailed results analysis of the peak hour queue lengths, and where appropriate delay, is provided below for the main junctions in the VISSIM network. The graphs shown below represent the maximum queue recorded during each 5-minute period, averaged for all the simulation runs in each scenario. A full set of queue graphs for all junctions can be found in Appendix C.

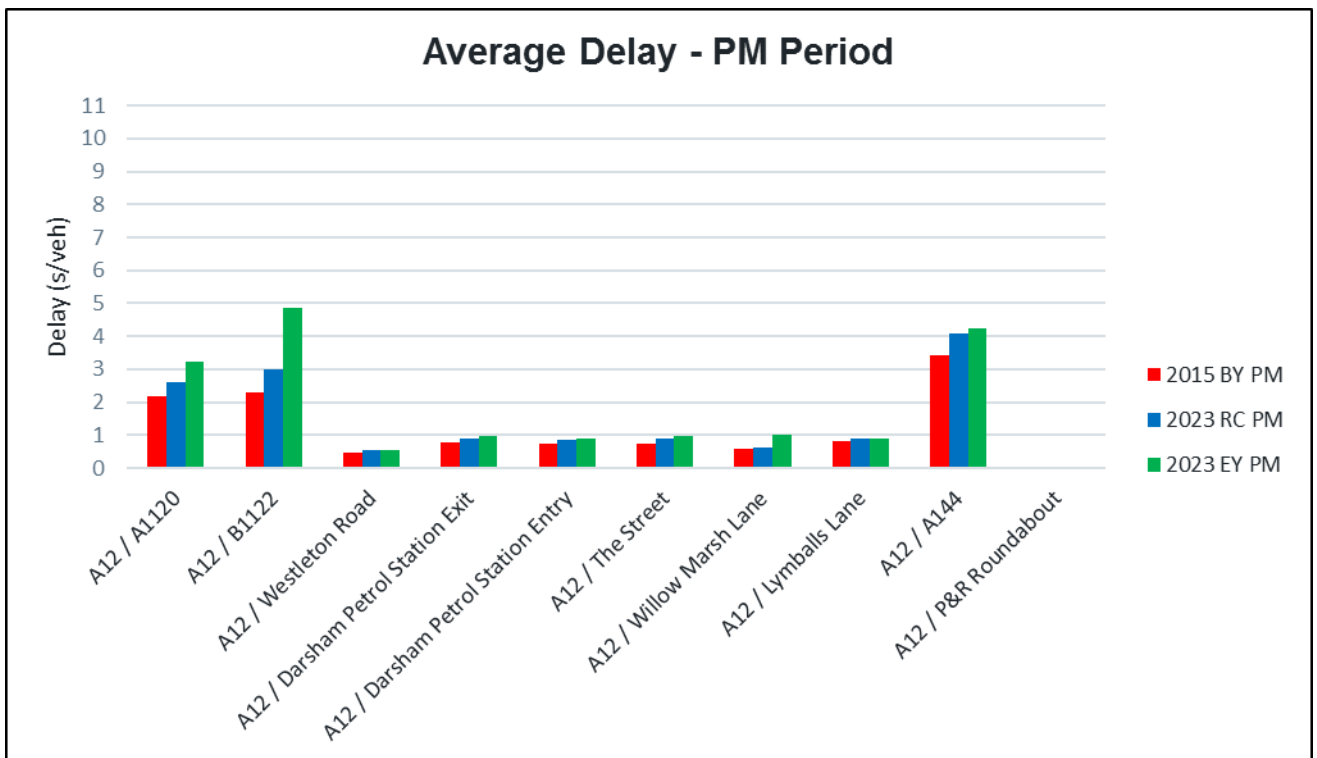
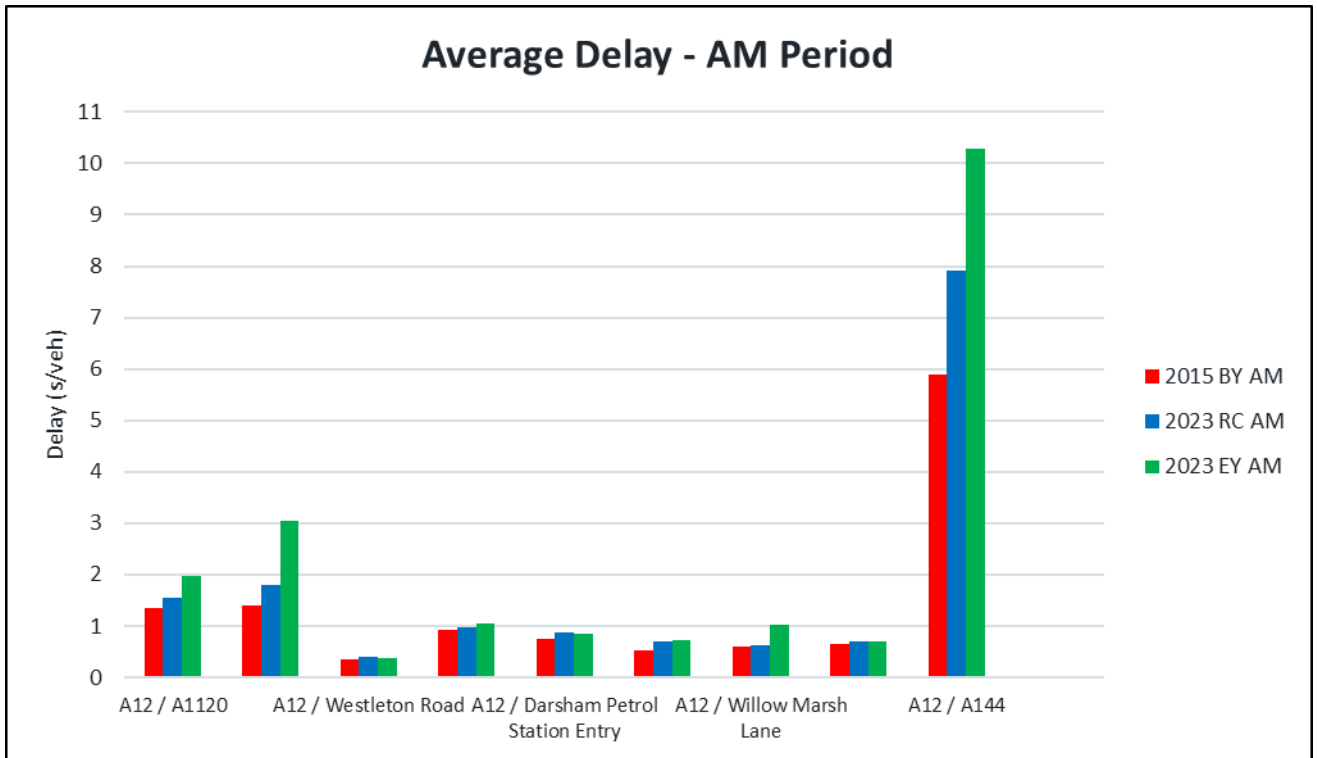

Figure 28 – Junction Average Delay

A12 / A1120

5.2.11. Figure 29 shows the modelled queue lengths during the AM period at the A12 / A1120 junction. The graphs indicate that there is no queuing between 6 and 7 am, and that queues remain short (no more than 40m / 7 vehicles) during the rest of the AM period. There is little variation between the Reference Case and Early Years scenarios.

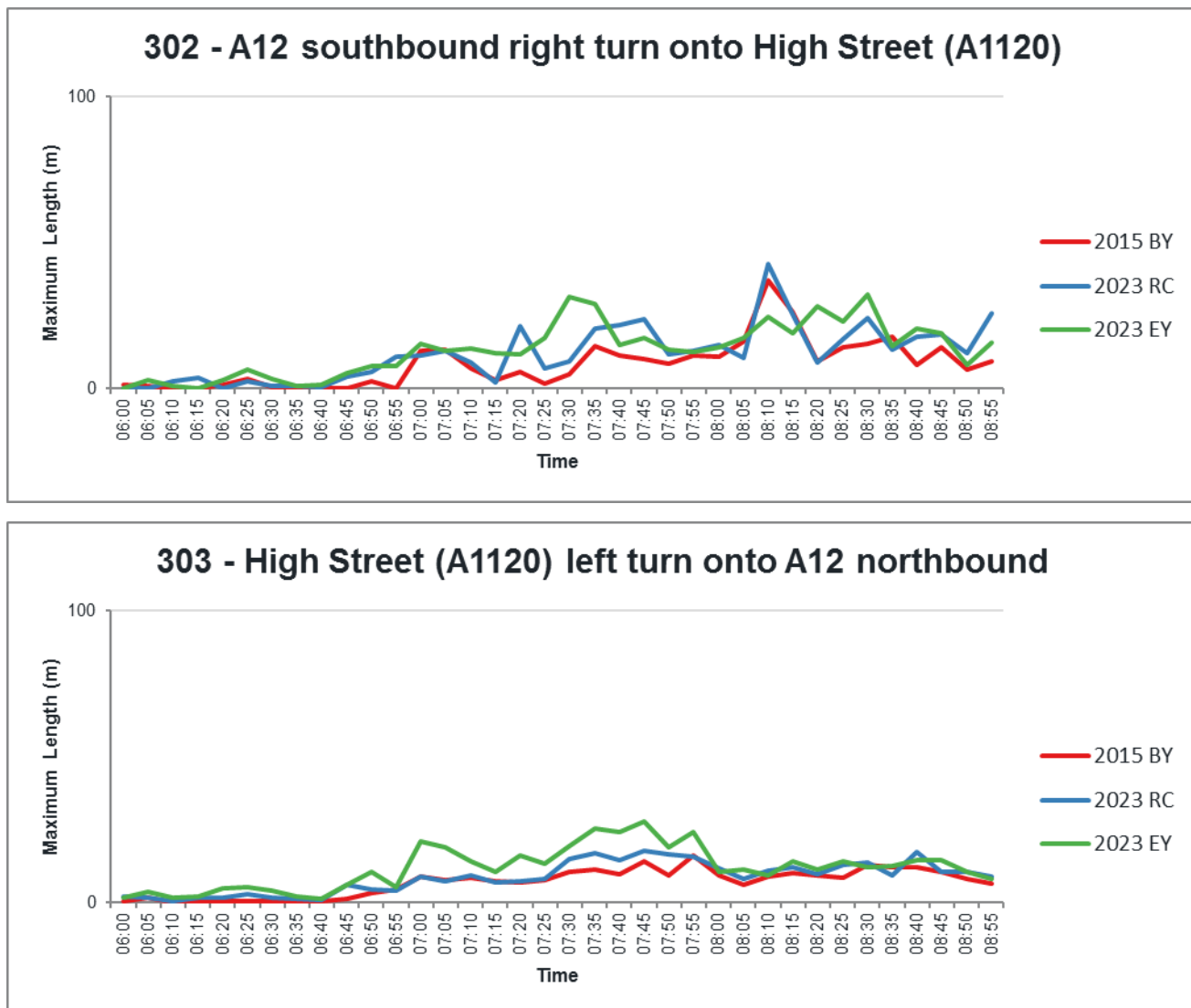

Figure 29 – A12 / A1120 AM Queue lengths

5.2.12. Due to the proximity between the A12 / A1120 and A12 / B1122 junctions, a more detailed analysis has been performed on the A12 southbound approach to the A1120 Yoxford High Street junction to assess the impact on the upstream junction, shown in Table 22. When the individual simulation runs are analysed, a large variability in queue length is shown in the model on the A12 southbound movement (queue counter #302) over time and between simulation runs. This is due to the varying gaps in A12 northbound traffic that opposes this movement. The variability in the presence of right-turning traffic, and the gaps in the northbound flow, results in fluctuating queue lengths which could reach back to the existing A12 / B1122 junction which is located approximately 150m upstream.

5.2.13. However, during the AM period, no runs in either the 2023 Reference Case scenario or the 2023 Early Years scenario show a maximum queue of more than 150m, thus never reaching the existing A12 / B1122 junction.

Table 22 – A12 / A1120 queue spillback analysis – AM period

Scenario	Stacking distance between A12 / A1120 and existing A12 / B1122 (m)	Percentage of runs where queue reaches existing B1122 junction (%)	Length of time during which queue reaches existing B1122 junction	Absolute maximum queue (m)
2015 Base Year	150	0%	-	87
2023 Reference Case	150	0%	-	95
2023 Early Years	150	0%	-	98

5.2.14. Figure 30 shows the queue lengths during the PM period at the A12 / A1120 junction. The right-turn queues from the A12 southbound approach are higher in the PM period compared to the AM period. The queue in the Early Years Scenario are most noticeably higher than the Reference Case between 17:00 and 18:00, where the queue is approximately 30m longer but, on average, they do not exceed the 150m stacking area available. The queues on the High Street remain low during the modelled period.

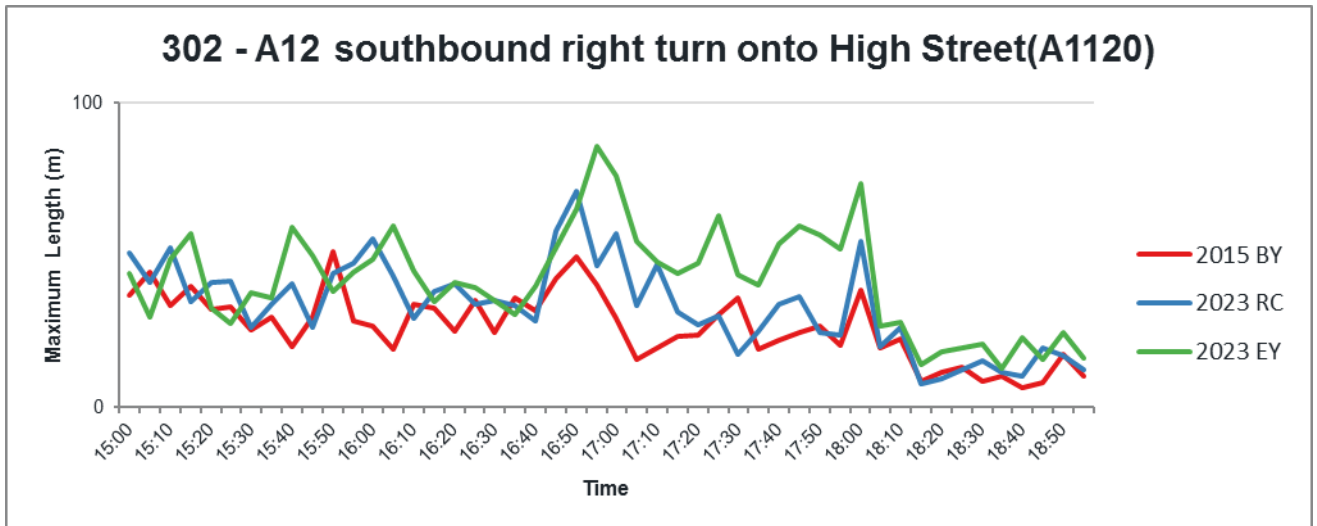

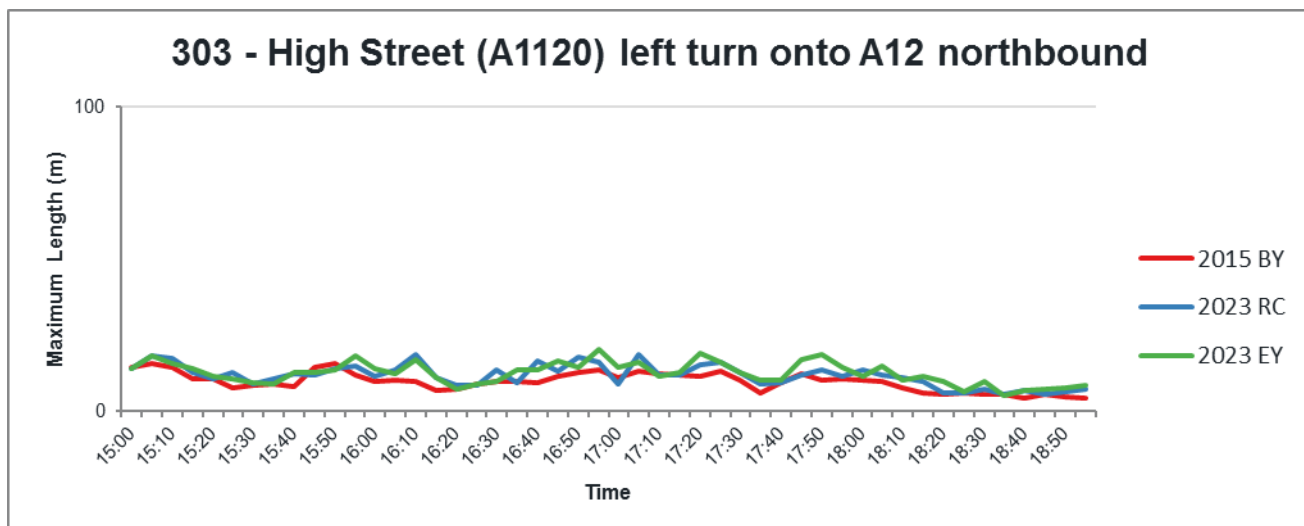

Figure 30 – A12 / A1120 PM Queue lengths

5.2.15. As with the AM period, a more detailed analysis has been conducted on the A12 southbound approach to determine the impact on the upstream junction, as shown in Table 23. This indicated that two runs in the 2023 Reference Case scenario and four out of ten runs in the 2023 Early Years scenario show a maximum queue of more than 150m at least once during the simulation, thus reaching the existing A12 / B1122 junction. This level of queueing occurs for less than five minutes in all runs and therefore impact is confined to a short period of time.

Table 23 – A12 / A1120 queue spillback analysis – PM period

Scenario	Stacking distance between A12 / A1120 and existing A12 / B1122 (m)	Percentage of runs where queue reaches existing B1122 junction (%)	Length of time during which queue reaches existing B1122 junction	Absolute maximum queue (m)
2015 Base Year	150	10%	< 5 min	168
2023 Reference Case	150	20%	< 5 min	174
2023 Early Years	150	40%	< 5 min	183

A12 / B1122

5.2.16. Figure 31 shows the modelled queue lengths during the AM period at the existing A12 / B1122 junction. The graph indicates that queues for the right turning movement from the A12 northbound onto the B1122 are predicted to be approximately 14m (two vehicles) during the Reference Case scenario which is expected to increase to a maximum queue of 26m (four vehicles) in the 2023 Early Years scenario.

5.2.17. The queues on the B1122 approach in the 2023 Reference Case are predicted to increase slightly compared to the 2015 Base scenario. An increase in queues on the B1122 can be observed from a

maximum of 20m (three vehicles) in the Reference Case scenario to 55m (nine vehicles) in the Early Years scenario, especially from 07:30-08:00. This indicates that the Sizewell C traffic will have a small impact on the junction for a short period of time during the AM Peak.

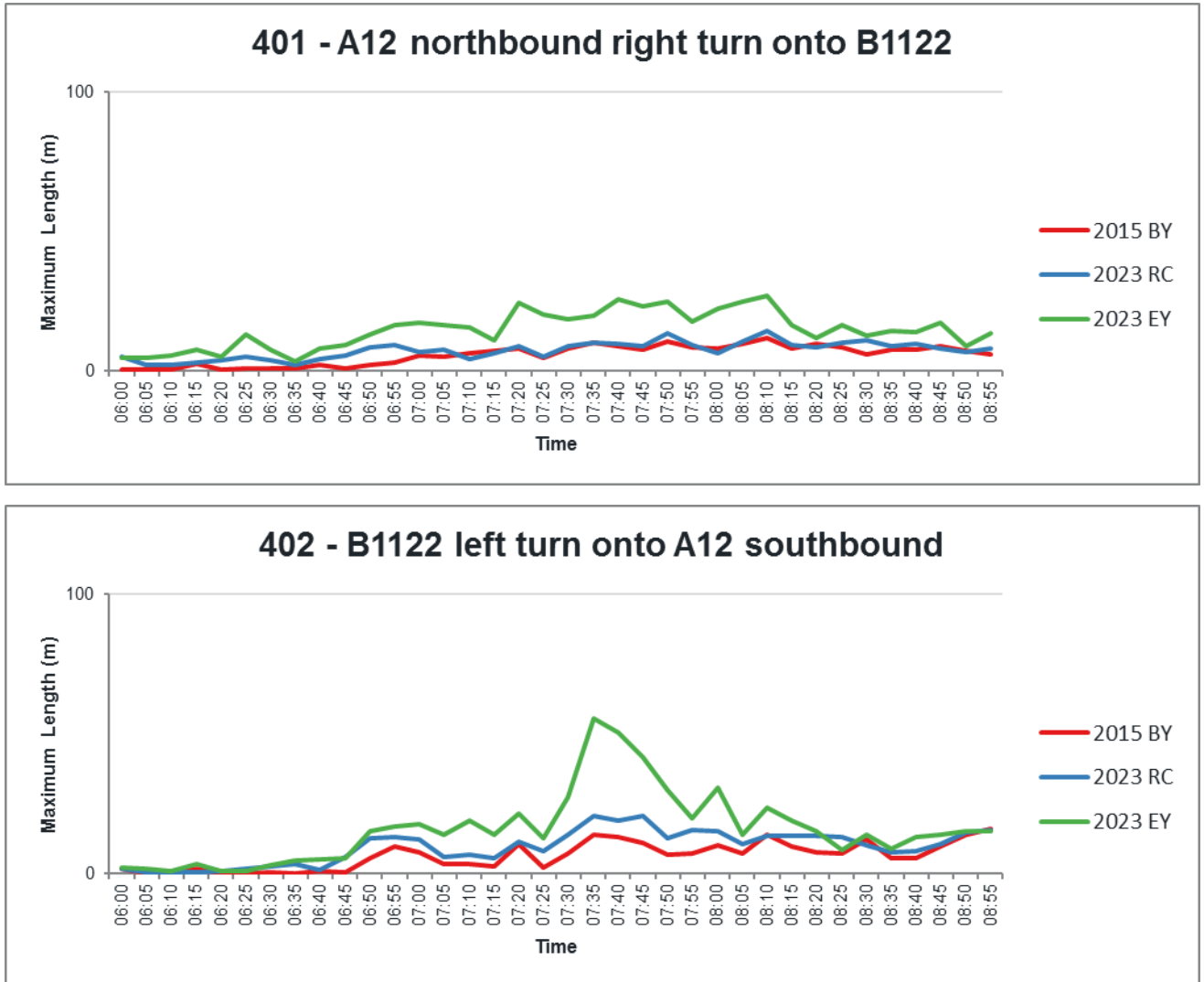

Figure 31 – A12 / B1122 AM Queue lengths

- 5.2.18. Due to the queuing on the B1122, additional analysis has been performed for the time period from 07:00-08:00 for the main movements at the junction. This analysis is shown in Table 24.
- 5.2.19. There is an increase in delay on the B1122 in the Early Years scenario compared to the Reference Case. The delay increases from 6 seconds to 18 seconds on the left turn and from 15 to 35 seconds on the right turn. On the right turn from the A12 south to the B1122, the delay per vehicle increases from 5 seconds in the Reference Case to 7 seconds in the Early Years scenario.

Table 24 – A12 / B1122 delay analysis

	Movement Delay (s/veh) 07:00 – 08:00		
	A12 S – B1122	B1122 - A12 S	B1122 - A12 N
2023 Reference Case	5	6	15
2023 Early Years	7	18	35

5.2.20. Due to the proximity between the A12 / A1120 and A12 / B1122 junctions, a more detailed analysis has been performed on the A12 northbound approach to the existing B1122 junction (queue counter #401) to determine the impact on the upstream A1120 junction, as shown in Table 25. This table shows that the queue for the right turn into the B1122 does not block back to the A1120 junction in any of the scenarios.

Table 25 – A12 / B1122 queue spillback analysis – AM period

Scenario	Stacking distance between A12 / A1120 and existing A12 / B1122 (m)	Percentage of runs where queue reaches A1120 junction (%)	Length of time during which queue reaches A1120 junction	Absolute maximum queue (m)
2015 Base Year	150	0	-	25
2023 Reference Case	150	0	-	31
2023 Early Years	150	0	-	80

5.2.21. Figure 32 shows the queue lengths during the PM period at the existing A12 / B1122 junction. The first graph shows that the queues at the A12 northbound right-turn lane are slightly increased in the Early Years Scenario compared to the Reference Case.

5.2.22. The queues on the minor arm (B1122) are generally higher during the PM period than in the AM period especially from 16:45-18:15. They are moderately increased in the Early Years scenario compared to the Reference Case. The maximum queue length for the Early Years scenario is 78m (thirteen vehicles), compared to 55m (nine vehicles) in the Reference Case.

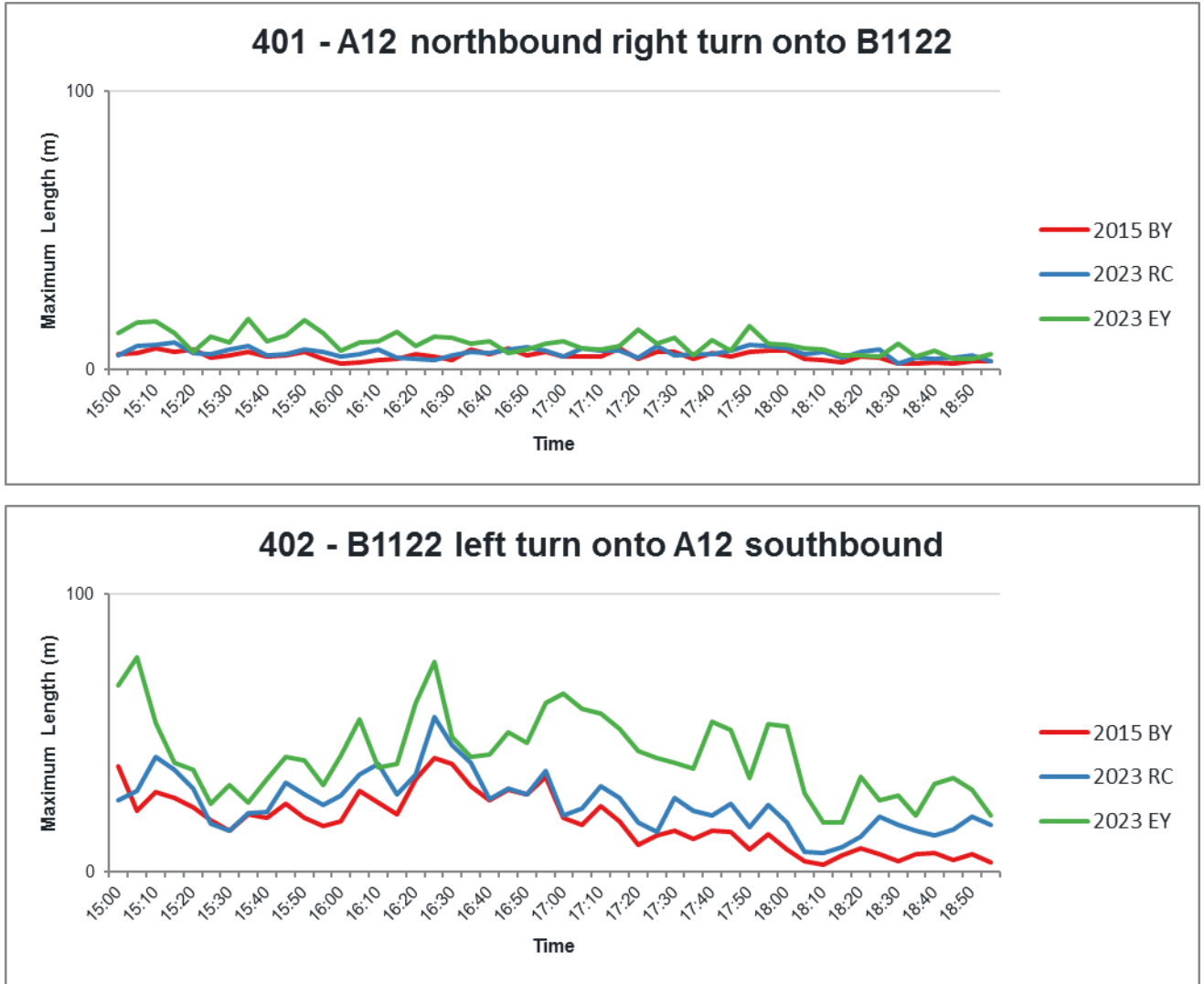

Figure 32 – A12 / B1122 PM Queue lengths

- 5.2.23. Due to the long queues seen on the B1122 an additional analysis on the delay between 17:00 and 18:00 for the main movements at the junction is shown in Table 26.
- 5.2.24. There is a moderate increase in delay from the B1122 in the Early Years scenario compared to the Reference Case. The delay increases from 8 seconds to 21 seconds per vehicle on the left turn and from 25 to 41 seconds per vehicle on the right turn.

Table 26 – A12 / B1122 PM delay analysis

	Movement Delay (s/veh) 17:00 – 18:00		
	A12 S – B1122	B1122 - A12 S	B1122 - A12 N
2023 Reference Case	5	8	25
2023 Early Years	5	21	41

5.2.25. As with the AM period analysis, a more detailed analysis has been performed on the A12 northbound approach (queue counter #401) for the PM period, as shown in Table 27. The table shows that the right turn queue into the B1122 does not reach the A1120 junction in any scenarios or runs.

Table 27 – A12 / B1122 queue spillback analysis – PM period

Scenario	Stacking distance between A12 / A1120 and existing A12 / B1122 (m)	Percentage of runs where queue reaches A1120 junction (%)	Length of time during which queue reaches A1120 junction	Absolute maximum queue (m)
2015 Base Year	150	0	-	32
2023 Reference Case	150	0	-	26
2023 Early Years	150	0	-	58

5.2.26. The AM and PM results for the A12 / B1122 junction indicate that the Sizewell C traffic will have a slight impact on the junction during both peak periods but the existing t-junction is not expected to become over-capacity in 2023. If it is found that the Sizewell C traffic has an impact on the performance of the minor arm in 2023, it may be possible to provide additional bus services to/from Sizewell C prior to the provision of the proposed roundabout mitigation scheme. The Sizewell C related traffic flows using the B1122 at this junction are mainly heading towards the A1120 and A144.

A12 / A144

5.2.27. Figure 33 shows the queue lengths during the AM period at the A12 / A144 junction. The first graph shows that the queues on the A12 southbound right-turn lane are small in all scenarios. The second graph shows an increasing trend in queue lengths for the A144 approach, with the 07:00-08:15 period experiencing the longest queue lengths. The extra vehicles from the Early Years scenario increase the queue length only during this time period with relatively little impact felt during the rest of the AM period. During the AM peak period, the average queue is 8m (one or two vehicles) longer than the Reference Case, and an overall maximum queue of 91m (fifteen vehicles) compared with 70m (twelve vehicles) in the Reference Case. However, this increase does not have a significant effect on the overall junction performance as the maximum queue lengths quoted are not consistently present during each 5-minute interval as queues at this location are quite variable.

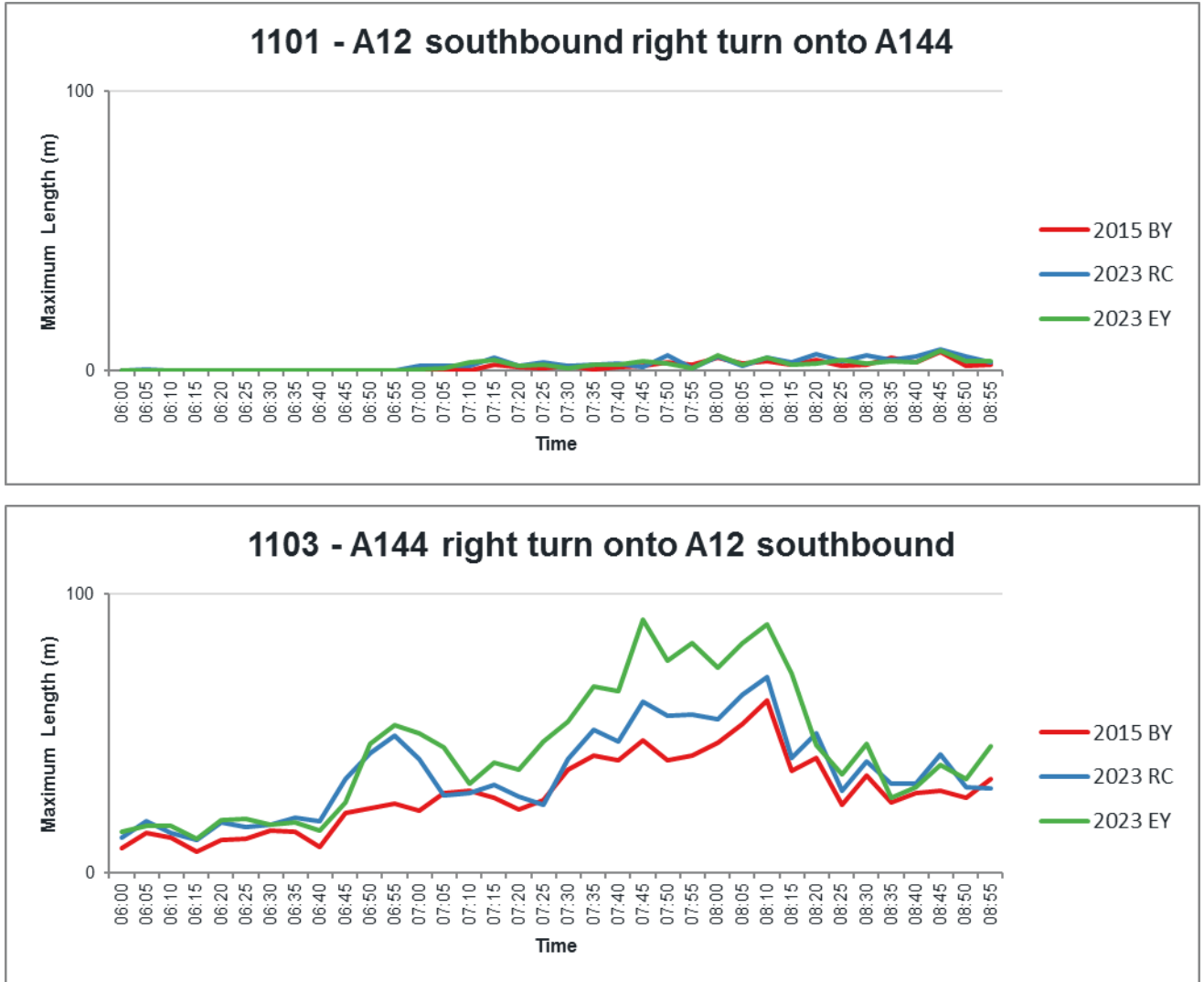

Figure 33 – A12 / A144 AM Queue lengths

5.2.28. Figure 34 shows the queue lengths during the PM period at the A12 / A144 junction. As in the AM period, there is barely any queuing at the A12 southbound right-turn lane during the PM. The queues on the A144 are much shorter in the PM compared to the AM period, with maximum queues of 38m (six vehicles). There is little difference in queue lengths between the 2023 Reference Case and Early Years scenario.

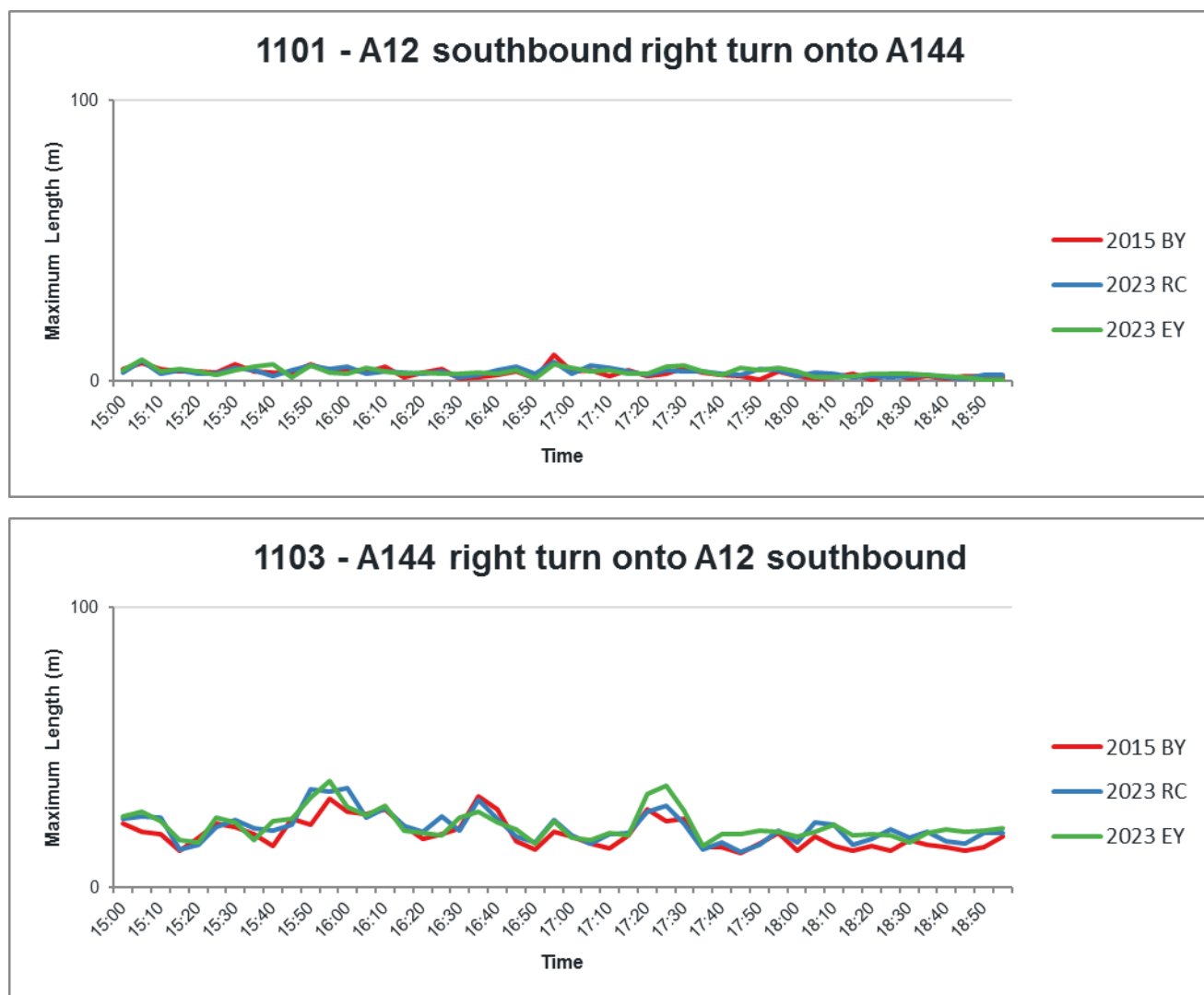

Figure 34 – A12 / A144 PM Queue lengths

PERFORMANCE SUMMARY

- 5.2.29. The Sizewell C construction traffic in 2023 does not have a significant impact in the overall highway network around Yoxford but it does have a small effect in some localised areas.
- 5.2.30. The network performance statistics indicate that the average time, distance and delay that vehicles experience in the network remains virtually unchanged and the journey time for vehicles travelling along the A12 would show very little change.
- 5.2.31. However, the addition of Sizewell C construction traffic does result in some increases in queues and delays on the B1122 approach from 07:30-08:00 and 16:45-18:15 in the 2023 Early Years scenario prior to the park and ride sites and B1122 roundabout being opened. If it is found that the Sizewell C traffic has an impact on the performance of the minor arm in 2023, it may be possible to provide additional bus services to/from Sizewell C prior to the provision of the proposed roundabout mitigation scheme.
- 5.2.32. There is also a small increase in queuing on the A144 during the AM peak from 07:00-08:15, although the queues at all other peak times are similar to the Reference Case.

- 5.2.33. In addition, the right turn queue from the A12 southbound onto the A1120 would occasionally reach back to the upstream junction in the PM Peak. However, this situation is only like to occur for less than five minutes before the queue dissipates and it is therefore unlikely to have a significant impact on delays in this area.

6. FORECAST SCENARIO – 2028 PEAK CONSTRUCTION

6.1. SCENARIO ASSUMPTIONS

- 6.1.1. 2028 represents the peak construction year of Sizewell C. A total of 7,900 workers would be deployed at the Sizewell C construction site, with a further 600 associated development workers. From these, 2,400 workers will reside in the on-site campus, 600 will stay in the 400 caravans on LEEIE and the rest travel from other locations as predicted by the gravity model.
- 6.1.2. By 2028 the northern and southern park and ride sites will be fully operational and will have a high-frequency service connecting them to the Sizewell C construction site. In addition, direct bus services will be provided from Lowestoft and Ipswich via the A12.
- 6.1.3. Two mitigation measures are proposed south of the modelled area:
- A two village bypass at Farnham and Stratford St Andrew and
 - Sizewell Link Road, joining the A12 south of Yoxford to the B1122 east of Theberton.
- 6.1.4. VISSIM has been used to assess the 2028 Peak Construction busiest day scenario which assumes 500 HGV deliveries per day (each way) will be made to the construction site. The proposed HGV delivery profile across the day is the same as that assumed in 2023, which is shown in Figure 23.
- 6.1.5. All Sizewell C HGVs and buses are assumed to route via the A12, with those from the south using the proposed Sizewell Link Road. Those from the north would use the B1122 and join the Sizewell Link Road west of Middleton Moor.

TRANSPORT NETWORK ASSUMPTIONS

- 6.1.6. The 2028 peak construction scenario assumes three main changes in the network within the VISSIM model extent. The first one is the embedded mitigation at the A12 / B1122 junction, which changes from a T junction to a roundabout by 2028. Figure 35 shows how the junction was included in the model both before and after the mitigation implementation. Priority rules were included at each arm to replicate gap acceptance behaviour. Different rules were set up for each lane of the approach, for light and heavy vehicles and for time and distance rules as per the guidance in the VISSIM user manual.



Figure 35 – A12 / B1122 junction before and after embedded mitigation

6.1.7. The second major change in the transport network is the introduction of the northern park and ride site access. The northern park and ride is assumed to be located north of Darsham Railway Station and west of the A12, and will be accessed through a new roundabout on the A12. Willow Marsh Lane will be severed from the A12 at its existing connection point, and will be accessed via a new T-junction accessed via the new roundabout on the A12. Figure 36 shows the modelled northern park and ride site access before and after its construction. Priority rules were included on each arm of the roundabout to replicate gap acceptance behaviour. Different rules were set up for each lane of the approach, for light and heavy vehicles and for time and distance rules as per the guidance in the VISSIM user manual.

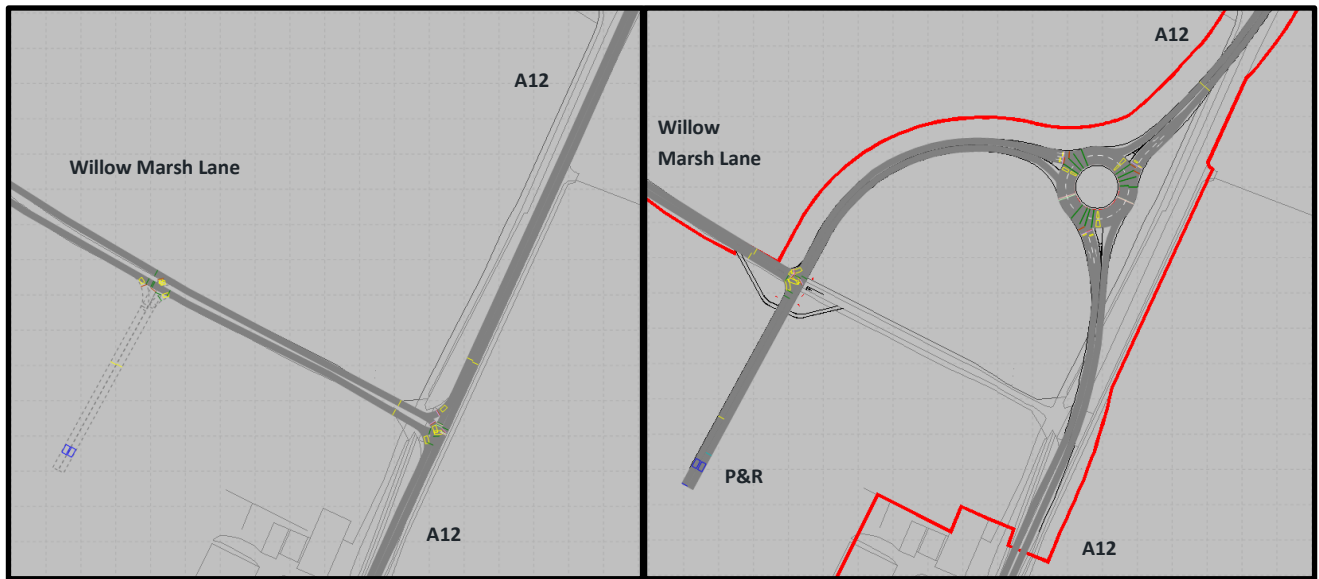

Figure 36 – Northern park and ride site access before and after construction

6.1.8. The third major change in the transport network is the embedded mitigation at the A12 / A144 junction, where the T-junction is assumed to be upgraded from a ghost-island T-junction to a single lane dualled t-junction. The junction would be widened to accommodate a central island which would provide more space between the two A12 carriageways for vehicles right turning from the A144. This would allow light vehicles right turning from the A144 to make the movement in two steps, stopping in the central reservoir if necessary. Figure 37 shows the modelled A12/A144 junction before and after its construction.

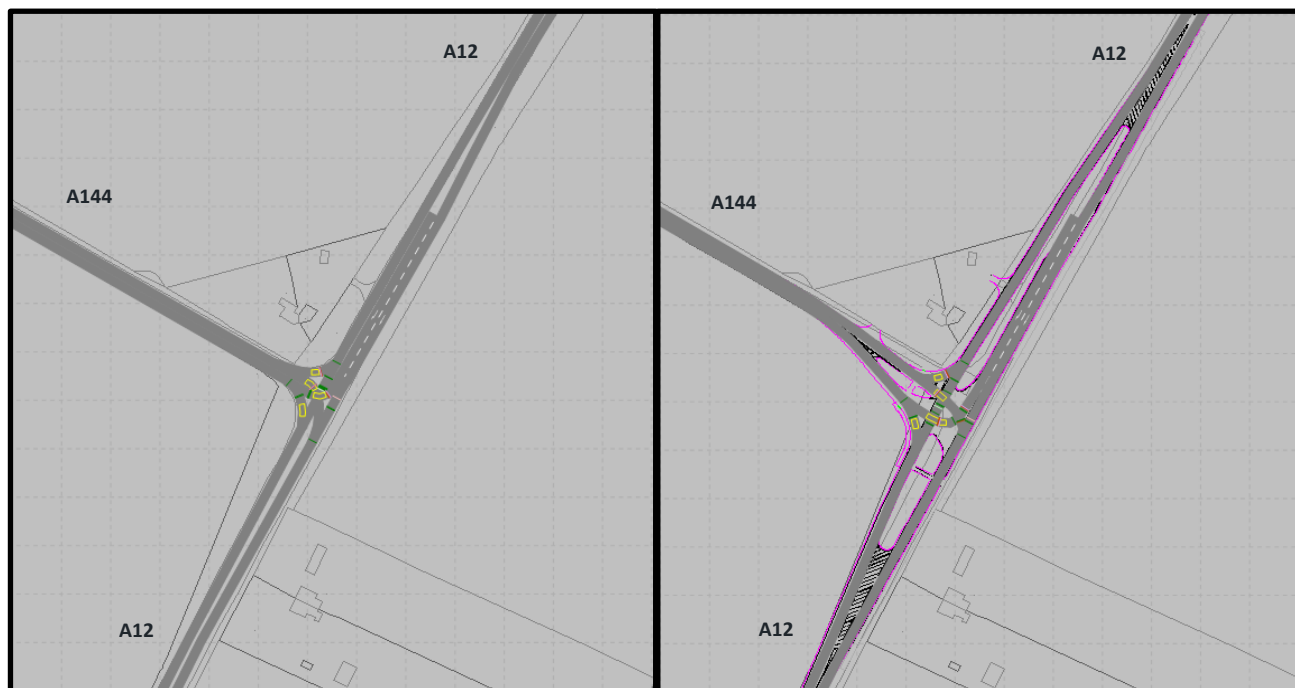

Figure 37 – A12 / A144 junction before and after construction

6.1.9. The detailed drawing of all the mitigations can be found in Appendix F.

TRAFFIC DEMAND ASSUMPTIONS - 2028

VISSIM matrices

- 6.1.10. As in the 2023 forecast scenario, the base, growth and Sizewell C private vehicle traffic was included in the model as dynamically assigned matrices calculated from the VISUM model. The same method of extracting and calculating the forecast matrices for VISSIM has been used.
- 6.1.11. Sizewell C construction traffic was extracted from the 2028 Peak Construction VISUM model which assumed a total peak construction workforce of 7,900 workers with an additional 600 AD workers.
- 6.1.1. Table 28 and Table 29 show the breakdown of total input matrix flows for the whole network by hourly time period for the Reference Case and Early Years scenarios respectively.

Table 28 – 2028 Network Traffic Reference Case (in vehicles per hour)

	6-7 am	7-8 am	8-9 am	3-4 pm	4-5 pm	5-6 pm	6-7 pm
Base 2028	515	1,165	1,375	1,517	1,589	1,465	1,086
Background Growth	203	228	188	233	195	226	266
Sizewell C	-	-	-	-	-	-	-
Total	718	1,393	1,562	1,749	1,784	1,691	1,352

Table 29 – 2028 Network Traffic Peak Construction (in vehicles per hour)

	6–7 am	7–8 am	8–9 am	3-4 pm	4-5 pm	5-6 pm	6-7 pm
Base 2028	503	1,131	1,333	1,473	1,513	1,410	1,056
Background Growth	206	221	177	219	219	191	251
Sizewell C	348	300	66	202	124	170	327
Total	1,057	1,652	1,576	1,893	1,857	1,771	1,635

Sizewell Bus services and HGV Deliveries

- 6.1.2. In addition to the private worker traffic input as matrices in the model, there are other vehicle movements associated with Sizewell C:
- Buses shuttling workers between:
 - Northern park and ride site and Sizewell C construction site;
 - Lowestoft and Sizewell C construction site.
 - HGVs delivering construction materials and plant movements to and from Sizewell C construction site.
- 6.1.3. Bus services to/from Leiston, Saxmundham, Ipswich, Woodbridge and Wickham Market Park & Ride and the Sizewell C construction site are included in the VISUM models but are not relevant to the VISSIM model.
- 6.1.4. Table 30 shows the Sizewell C bus services included in the 2028 Peak Construction scenario. These figures include the shuttle buses from northern park & ride to Sizewell as well as the direct bus lines to Lowestoft. The bus services were modelled in VISSIM as “Public Transport Lines” on fixed routes.

Table 30 – 2028 Sizewell C Bus services

Service	6-7am	7-8am	8-9am	3-4pm	4-5pm	5-6pm	6-7pm
Northern park & ride - SZC	6	6	3	3	3	3	3
SZC - Northern park & ride	6	6	3	3	3	3	3
Lowestoft - SZC	2	2	2	2	2	2	2
SZC - Lowestoft	2	2	1	2	2	2	2
Total	16	16	9	10	10	10	10

- 6.1.5. Table 31 shows the HGV deliveries on the busiest day, per hour, to Sizewell C construction site in the 2028 Peak Construction scenario. This table only takes into account the HGV deliveries from the north, as the deliveries coming from the south will use the Sizewell Link Road, which falls outside of the VISSIM model extent. These HGVs were modelled as vehicle type “202: HGV SZC” and assigned to “Public Transport Lines” with fixed routes and equally spaced departure times.

Table 31 – 2028 Sizewell C HGV deliveries

Delivery Site	Direction	6-7am	7-8am	8-9am	3-4pm	4-5pm	5-6pm	6-7pm
Sizewell C	Inbound	4	11	9	8	5	2	2
	Outbound	0	0	4	5	6	7	7
Total		4	11	13	13	11	9	9

6.2. SCENARIO PERFORMANCE COMPARISON

6.2.1. This section presents the performance comparison between the validated base year scenario (“2015”), the Reference Case scenario for 2028 (“2028 RC”), and the 2028 Peak Construction scenario (“2028 PC”) with Sizewell C construction traffic.

NETWORK-WIDE PERFORMANCE

6.2.2. Table 32 shows a series of network-wide statistics that were extracted from the outputs of the three different scenarios.

Table 32 – Network Performance Model Results

	AM			PM		
	2015	2028 RC	2028 PC	2015	2028 RC	2028 PC
Total Time Taken (h)	275	335	392	499	583	646
Total Distance (km)	17,193	20,645	23,777	31,021	35,642	38,887
Total Vehicles	3,124	3,745	4,446	5,858	6,764	7,452
Total Delay (h)	24	32	44	46	59	71
Avg. Time (s) / Vehicle	317	322	318	307	310	312
Avg. Time (s) / Mile	93	94	96	93	95	96
Avg. Distance (m) / Vehicle	5,504	5,513	5,348	5,295	5,269	5,218
Avg. Speed (mph)	39	38	38	39	38	37
Avg. Speed (kph)	63	62	61	62	61	60
Avg. Delay / Vehicle (s)	28	31	35	28	32	34

6.2.3. During the AM and PM peaks, the network-wide statistics show that time, distance and delay have a linear relationship with the number of vehicles in the network. This means that the addition of the Sizewell C vehicles result in little change to the distance and delay per vehicle when compared to the Reference Case and thus the network is not affected.

6.2.4. Reviewing the relative statistics, it is possible to observe that the variation between the different scenarios is low. For example, the VISSIM model predicts that the average driver will experience a delay increase of 4 seconds (+13%) in the 2028 PC AM period scenario compared to the 2028

Reference Case. During the PM peak, the average delay per vehicle is increased by 2 seconds (+6%).

- 6.2.5. This increased level of average delay is relatively low and hence does not have a significant impact in the network. The average speed throughout the network stays the same in the AM period and decreases by 1mph during the PM period in the Peak Construction scenario compared to the 2028 Reference Case.
- 6.2.6. Figure 38 shows the average journey time along the A12 for each scenario.

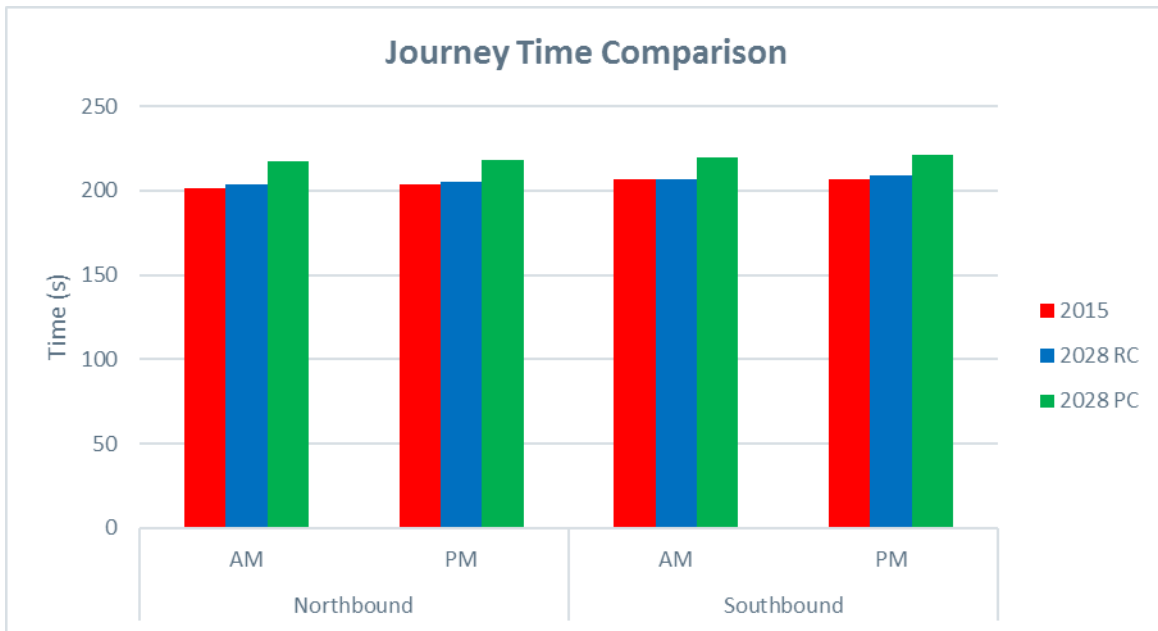

Figure 38 – 2028 Journey Time Comparison

- 6.2.7. The Peak Construction scenario has an average increase in journey time of 13 seconds compared to the Reference Case. This increase is mostly due to the introduction of both roundabouts (Northern park and ride access and B1122) along the A12, which add slight delay to the A12 movements. As the daily variation in travel times is likely to exceed a difference of 13 seconds, it is unlikely that a change of this magnitude would be perceivable to A12 road users.

JUNCTION PERFORMANCE

- 6.2.8. Queue and average delay results have been collected for all junctions in the model in order to assess the performance of each junction.
- 6.2.9. Figure 39 shows the average delay for each junction over the whole AM and PM periods. The values shown below represent the average of all turning movements in the junction.

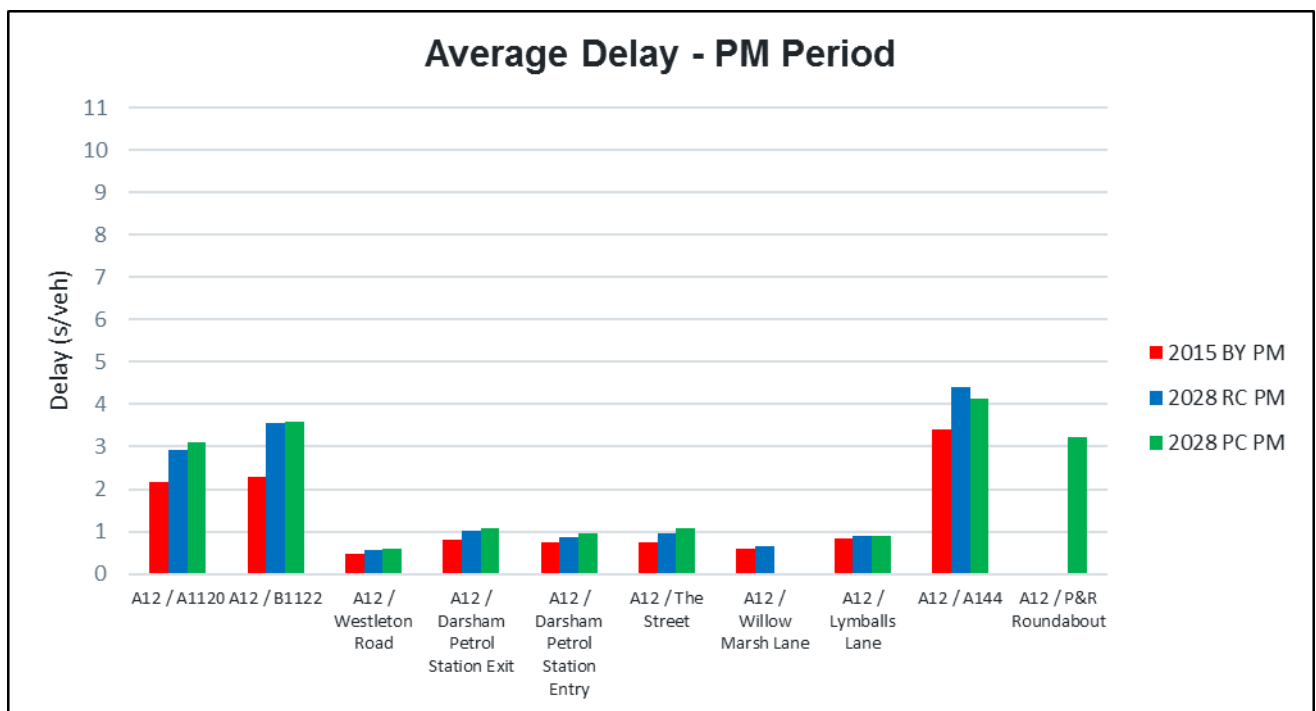
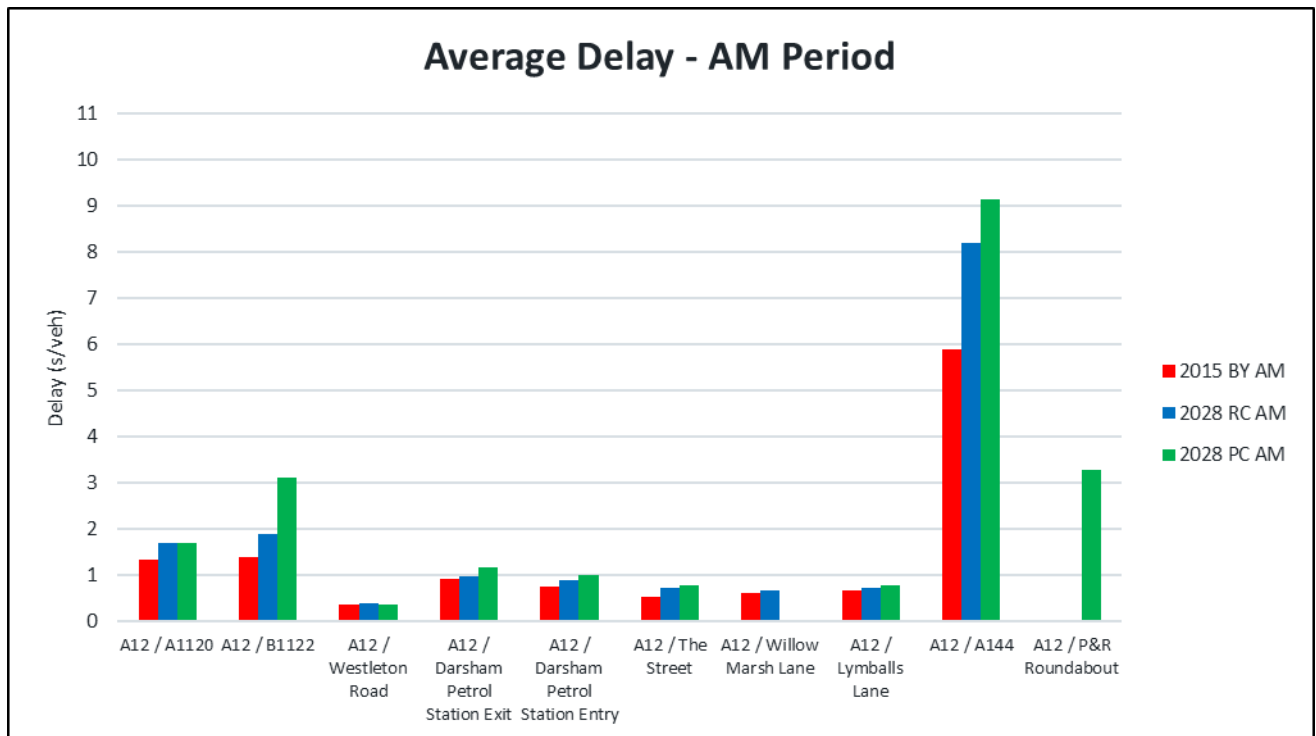

Figure 39 – Junction Average Delay

6.2.10. The graphs show that the level of delay is very low at the A12 junctions with Westleton Road, Darsham Petrol Station, The Street, Willow Marsh Lane and Lymballs Lane. A higher level of delay is observed at the A12 / A1120, A12 / B1122, A12 / A144 and A12 / P&R junctions. The addition of the Sizewell C construction traffic has a moderate impact on the A12 / A144 and A12 / B1122 junctions during the AM Period.

6.2.11. A detailed results analysis is provided below for the main junctions in the network; A12 / A1120, A12 / B1122, A12 / A144 and northern park & ride roundabout. The graphs shown below represent the maximum queue recorded during each 5-minute period, averaged over each iteration by scenario. A full set of queue graphs can be found in Appendix D.

A12 / A1120

6.2.12. Figure 40 shows the queue lengths during the AM period at the A12 / A1120 junction. The right-turn queues from the A12 southbound approach are similar in the 2028 Peak Construction compared to the Reference Case scenario. The queues on the High Street remain very low during the whole period in all scenarios.

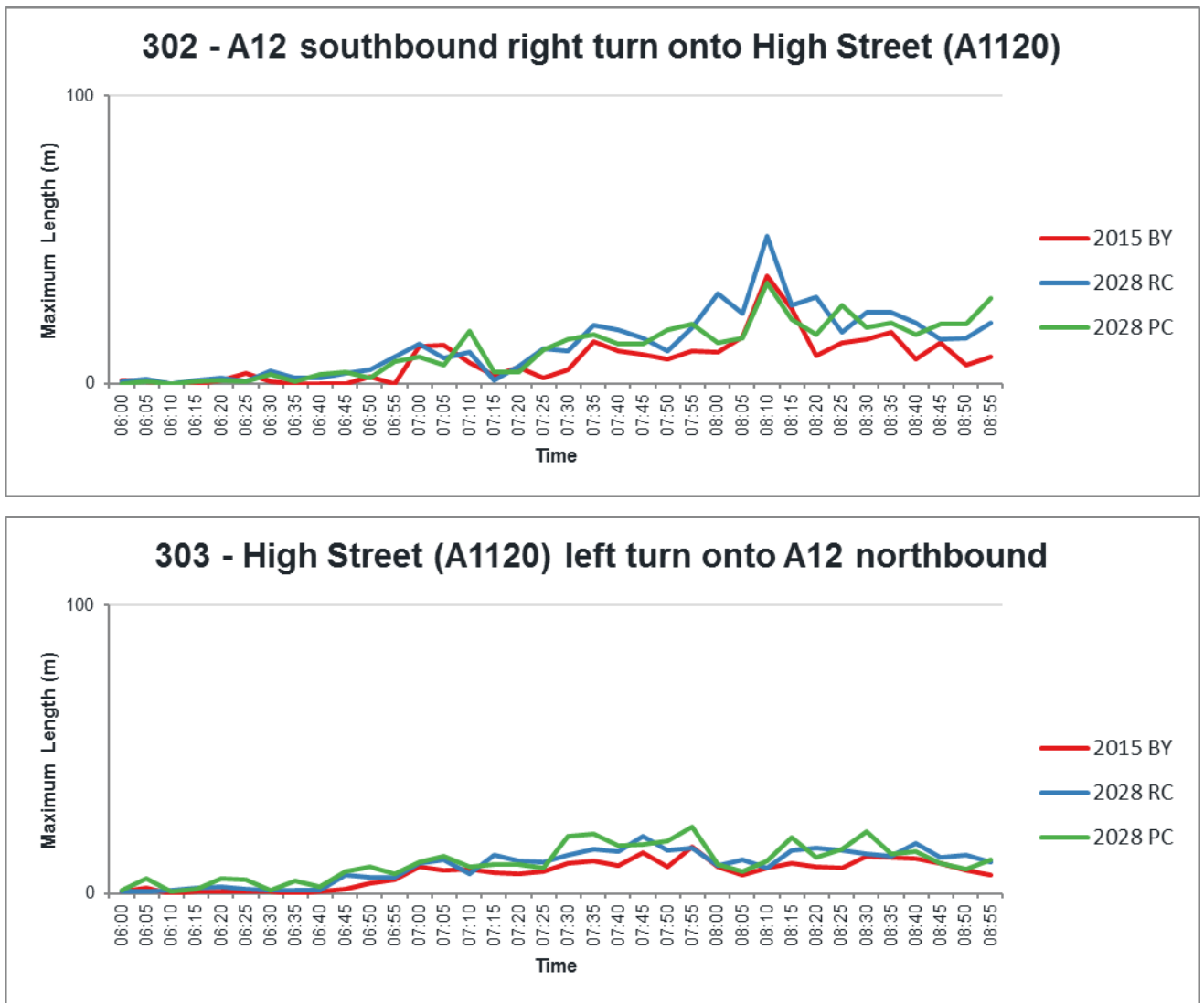

Figure 40 – A12 / A1120 AM Queue lengths

6.2.13. Due to the proximity between the A12 / A1120 and A12 / B1122 junctions, a more detailed analysis has been performed on the A12 southbound approach (queue counter #302) to determine whether the queue reaches the B1122 junction. As a result of the upgrade of the A12 / B1122 junction to a roundabout in the Peak Construction scenario, the stacking distance between the B1122 and A1120

junctions is increased from 150m (current layout) to 230m. Table 33 shows that the queue from the right turn into the A1120 doesn't reach the B1122 junction in any of the scenarios.

Table 33 – A12 / A1120 queue spillback analysis – AM period

Scenario	Stacking distance between A12 / A1120 and A12 / B1122 (m)	Percentage of runs where queue reaches A12/B1122 junction (%)	Length of time during which queue reaches A12/B1122 junction	Absolute maximum queue (m)
2028 Reference Case	150	0	-	113
2028 Peak Construction	230	0	-	128

6.2.14. Figure 41 shows the queue lengths during the PM period at the A12 / A1120 junction. The right-turn queues from the A12 southbound are similar in the Peak Construction scenario compared to the 2028 Reference Case, except for a short period 16:50-17:00 when the queue in the Peak construction case is approximately 30m (5 vehicles) longer than the 2028 Reference Case.

6.2.15. Queues on the A1120 High Street approach onto the A12 are largely unaffected in the Peak Construction scenario.

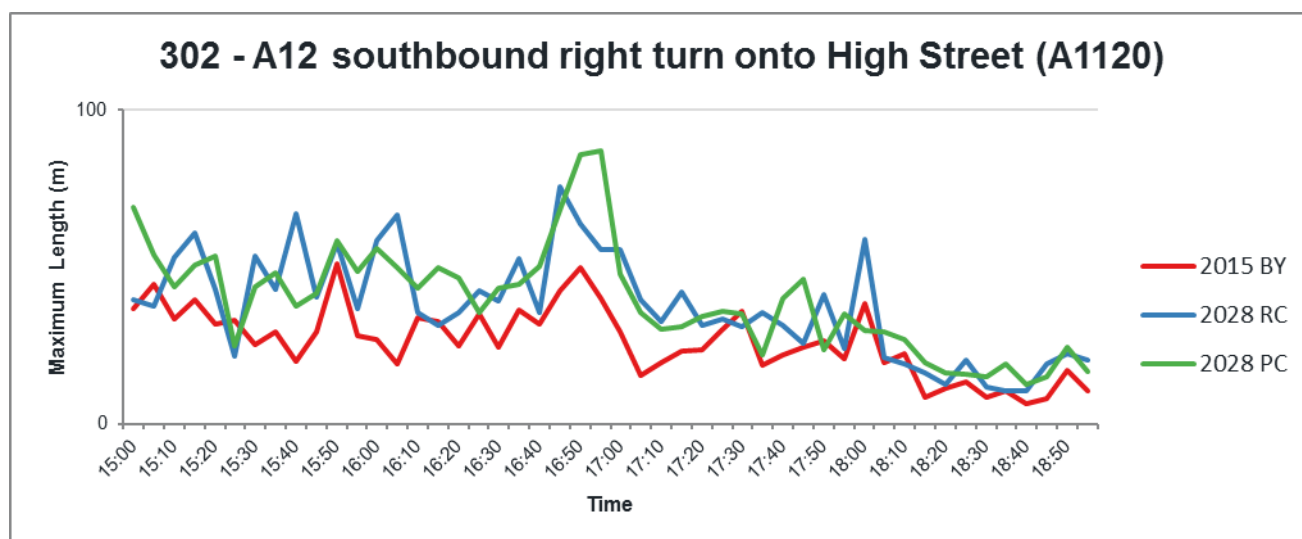

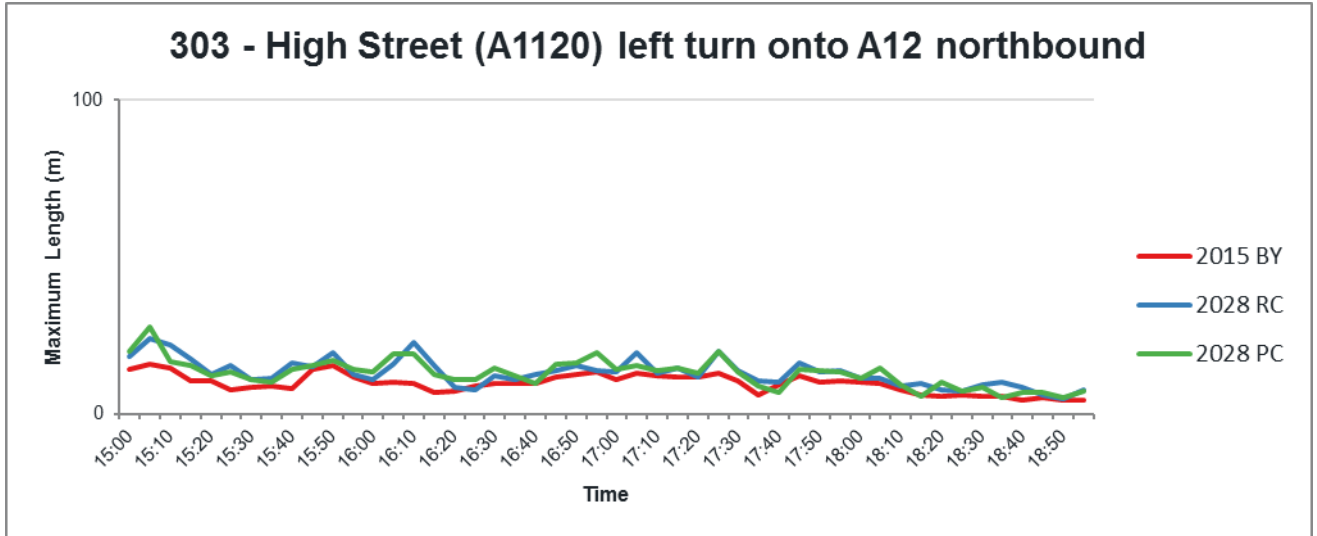

Figure 41 – A12 / A1120 PM Queue lengths

6.2.16. Due to the proximity between the A12 / A1120 and A12 / B1122 junctions, a more detailed analysis has been undertaken on the A12 southbound approach (queue counter #302) to determine the impact on the upstream junction, shown in Table 34. In the Reference Case, the queue reaches the upstream B1122 junction in 30% of the runs. In the Peak Construction scenario, it never reached the upstream A12 / B1122 junction. The increased distance between the junctions helps to mitigate any impact that could be created by the Sizewell C traffic.

Table 34 – A12 / A1120 queue spillback analysis – PM period

Scenario	Stacking distance between A12 / A1120 and A12 / B1122 (m)	Percentage of runs where queue reaches A12/B1122 junction (%)	Length of time during which queue reaches A12/B1122 junction	Absolute maximum queue (m)
2028 Reference Case	150	30	< 5 min	215
2028 Peak Construction	230	0	-	174

A12 / B1122

6.2.17. Figure 42 shows the queue lengths during the AM period at the A12 / B1122 junction. This junction was modelled as a t-junction in the 2015 and 2028 RC scenarios and as a roundabout in the 2028 Peak Construction scenario. The graph indicates that the queue lengths on the A12 northbound and B1122 westbound remain low in the Peak Construction scenario. There is likely to be some queuing on A12 southbound approach due to the introduction of the roundabout, with a maximum queue length of 32m (five vehicles). This queue would occur on the approach to Yoxford, rather than in the village itself and dissipates quickly.

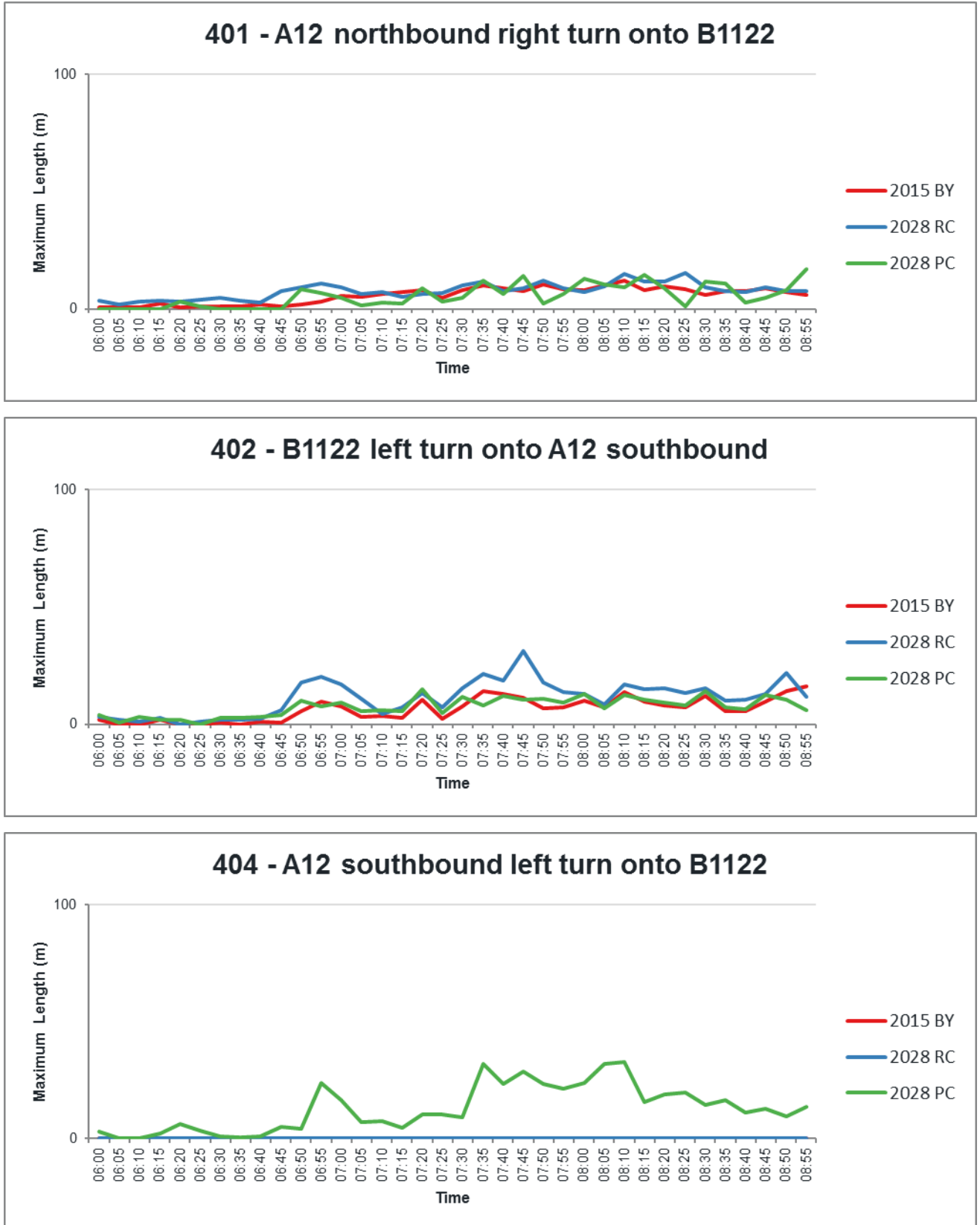

Figure 42 – A12 / B1122 AM Queue lengths

6.2.18. Due to the proximity between the A12 / A1120 and A12 / B1122 junctions, a more detailed analysis has been performed on the A12 northbound approach (queue counter #401) to determine the impact on the upstream A1120 junction, as shown in Table 35. This table shows that the upstream A1120 junction would not be blocked in any of the scenarios and the absolute maximum queue is far from reaching the A1120 junction.

Table 35 – A12 / B1122 AM spillback analysis

Scenario	Stacking distance between A12 / A1120 and A12 / B1122 (m)	Percentage of runs where queue reaches A1120 junction (%)	Length of time during which queue reaches A1120 junction	Absolute maximum queue (m)
2028 Reference Case	150	0	-	37
2028 Peak Construction	230	0	-	69

6.2.19. Due to the change of the A12/B1122 junction from a T-junction to a roundabout, the arms experiencing queues are different to those in the Reference Case. Thus, an additional assessment has been conducted to assess the delay during the most congested hour (08:00 – 09:00) as shown in Table 36.

6.2.20. This shows a reduction in delay on the B1122 approach. Conversely, the delay on the A12 is slightly increased, but remains low.

Table 36 – A12 / B1122 AM delay analysis

	Movement Delay (s/veh) 08:00 – 09:00					
	A12 S – A12 N	A12 S – B1122	A12 N – A12 S	A12 N – B1122	B1122 – A12 S	B1122 – A12 N
2028 Reference Case	0	6	1	1	8	21
2028 Peak Construction	2	3	5	3	5	6

6.2.21. Figure 43 shows the queue lengths during the PM period at the A12 / B1122 junction. In the Peak Construction scenario, the queue lengths remain the same or lower than the Reference Case for the B1122 approach (minor arm, T-junction), but they increase on the A12 approaches, especially southbound due to the introduction of the roundabout.

6.2.22. The new roundabout creates a short-term, intermittent queue on the A12 southbound approach for the Peak Construction scenario, with a maximum queue length of 50m (eight vehicles). Queues dissipate quickly and are generally moving rather than stationary so little impact is felt at this location.

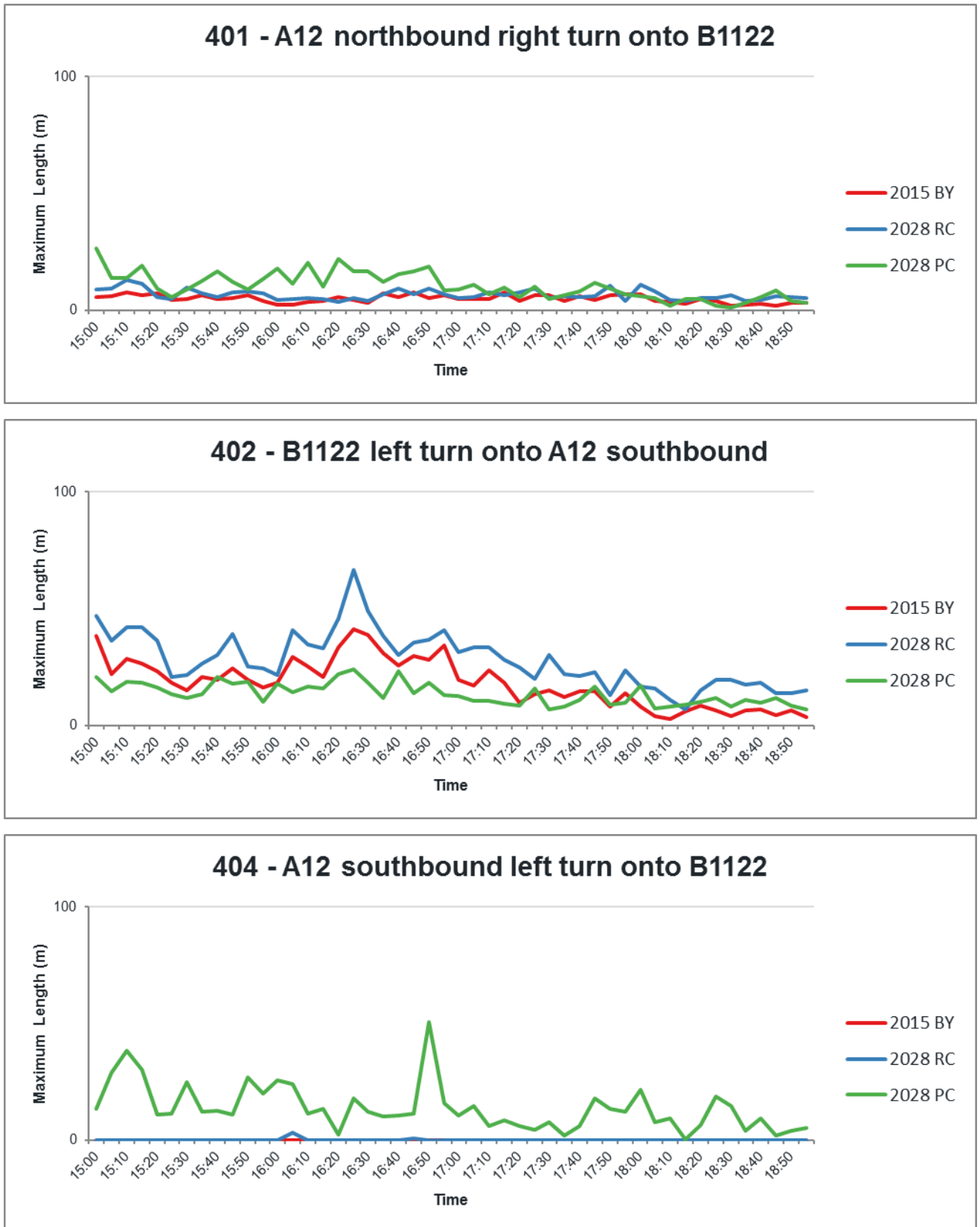

Figure 43 – A12 / B1122 PM Queue lengths

6.2.23. Due to the proximity between the A12 / A1120 and A12 / B1122 junctions, a more detailed analysis has been performed on the A12 northbound approach (queue counter #401) to determine the impact on the upstream A1120 junction, shown in Table 37. The table shows that the A12 northbound queue never reaches the A1120 junction in any of the scenarios and the absolute maximum queue is far from reaching this location.

Table 37 – A12 / B1122 queue spillback analysis – PM period

Scenario	Stacking distance between A12 / A1120 and A12 / B1122 (m)	Percentage of runs where queue reaches A1120 junction (%)	Length of time during which queue reaches A1120 junction	Absolute maximum queue (m)
2028 Reference Case	150	0	-	29
2028 Peak Construction	230	0	-	95

6.2.24. Due to the change of the A12/B1122 junction from a t-junction to a roundabout, the arms experiencing queues are different to those in the Reference Case. Thus, an additional analysis on the delay during the most congested hour (16:00-17:00) is shown in Table 38.

6.2.25. The level of delay experienced on the B1122 approach to the existing A12 junction in the Reference Case scenario during the PM period is the movement that experiences most delay at the t-junction. As a result of the upgrade to a roundabout, the B1122 traffic delay is reduced from 20s per vehicle for left-turning traffic and 37s per vehicle for right-turning traffic to 5-8s per vehicle. Due to the introduction of the roundabout, delay on the A12 is slightly increased, but remains low.

Table 38 – A12 / B1122 PM maximum delay analysis

	Movement Delay (s/veh) 16:00 – 17:00					
	A12 S – A12 N	A12 S – B1122	A12 N – A12 S	A12 N – B1122	B1122 – A12 S	B1122 – A12 N
2028 Reference Case	0	6	1	1	20	37
2028 Peak Construction	3	4	5	3	5	8

A12 / A144

6.2.26. Figure 44 shows the queue lengths during the AM period at the A12 / A144 junction. The queue on the A12 southbound right turn remains at a similar level in all scenarios. Although the junction has been upgraded, the queue length on the A144 approach is longer in the Peak Construction scenario than the Reference Case, most noticeably between 06:45 and 08:00. This is due to the much higher flow on the A144 due to the Sizewell C traffic. The maximum queue observed in the Peak Construction scenario is 82m (fourteen vehicles) compared to 73m (twelve vehicles) in the Reference Case.

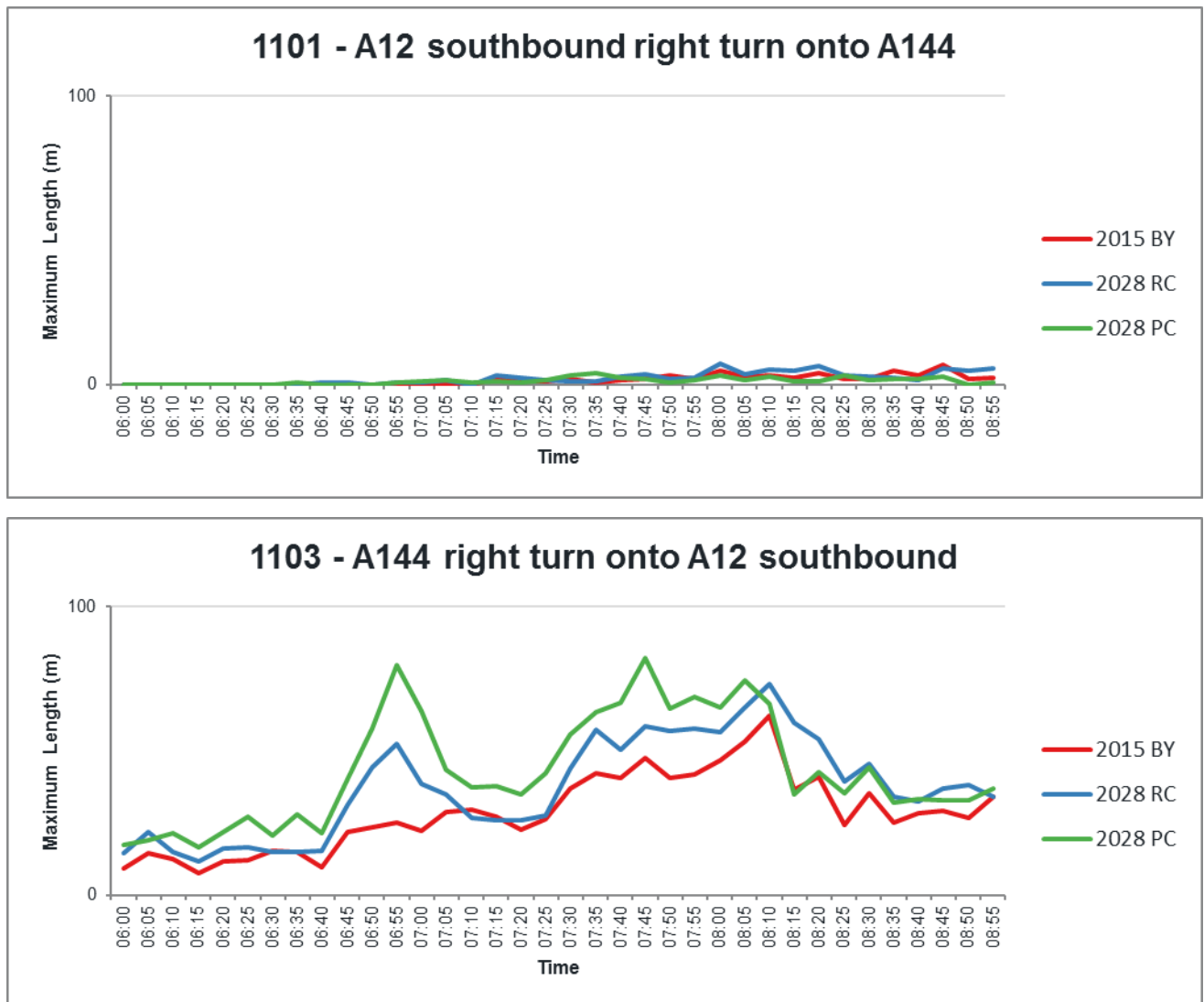

Figure 44 – A12 / A144 AM Queue lengths

6.2.27. Figure 45 shows the queue lengths during the PM period at the A12 / A144 junction. As with the AM period, there is little queuing on the A12 southbound right-turn lane during the PM period. The queues on the A144 are much shorter in the PM compared to the AM period and there is little difference in queue lengths between the Peak Construction and Reference Case scenarios.

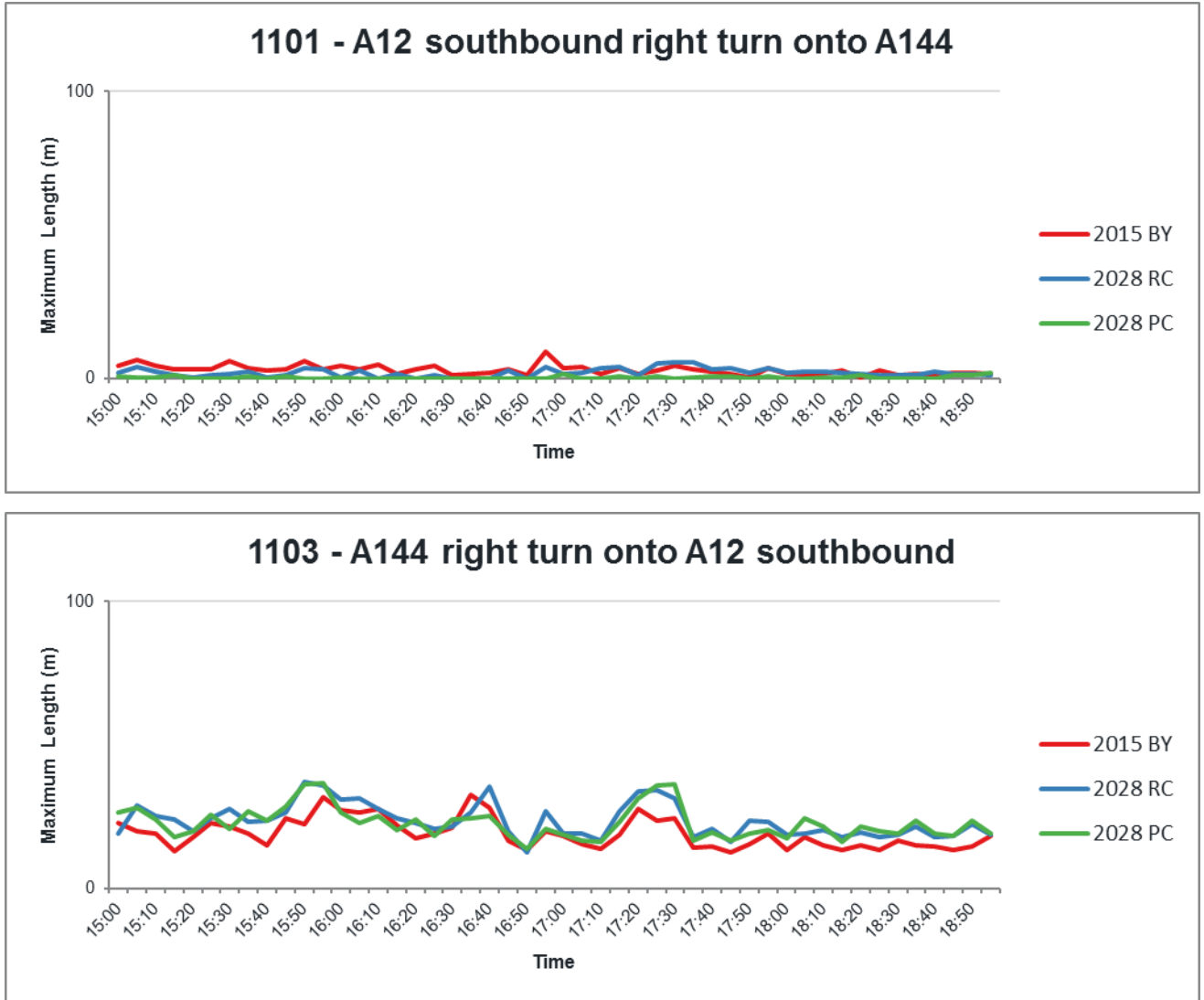

Figure 45 – A12 / A144 PM Queue lengths

Northern park and ride roundabout

6.2.28. Figure 46 shows the queue lengths during the AM period at the proposed northern park and ride roundabout. The maximum queue observed at the A12 northbound and southbound approaches is 35m (six vehicles). The queues on the P&R approach is not significant.

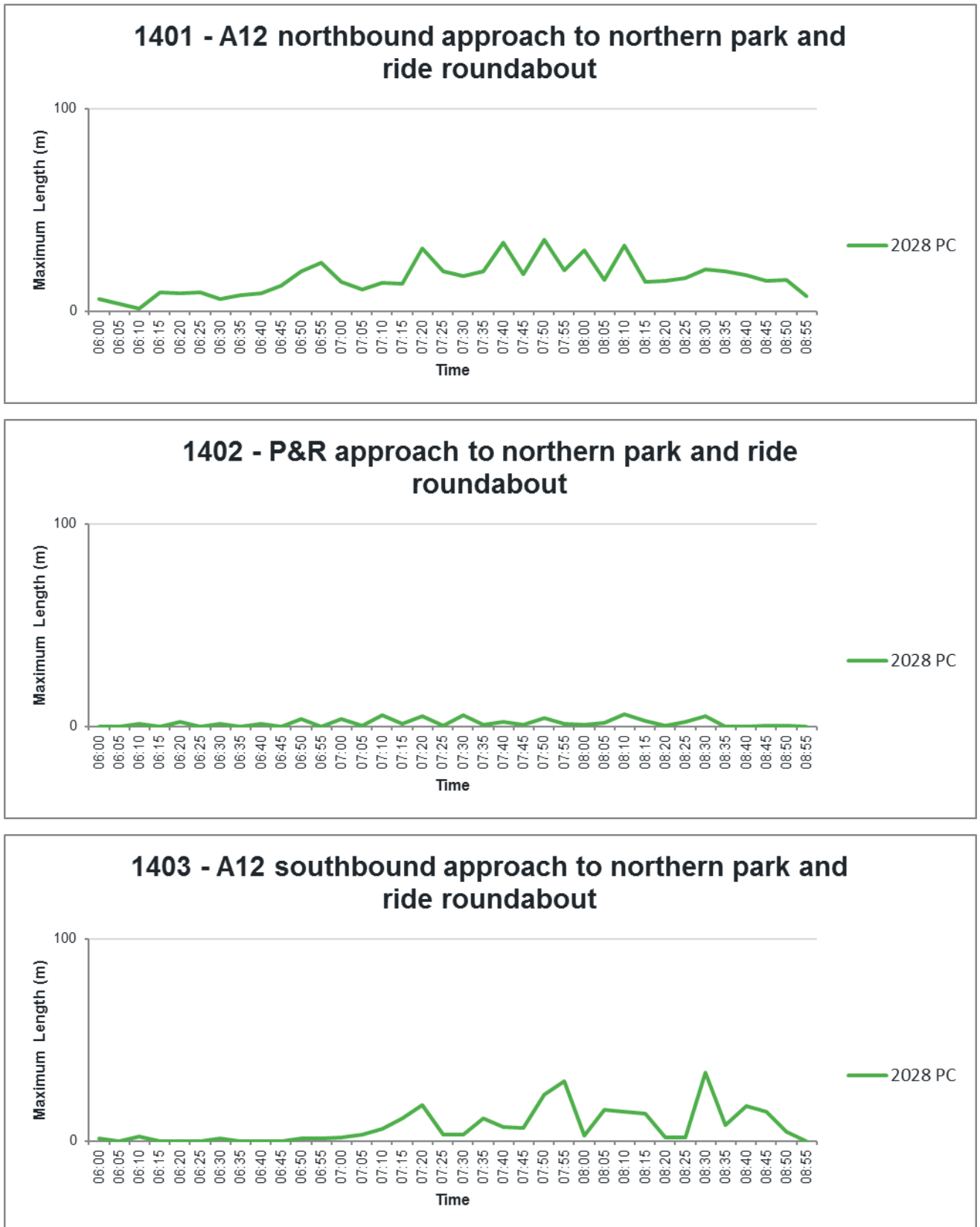

Figure 46 – Northern park and ride roundabout AM Queue lengths

- 6.2.29. The implementation of the roundabout results in a delay increase of 4 seconds per vehicle on the A12 northbound and southbound movements. This level of delay is very low and likely to be imperceptible.
- 6.2.30. Figure 47 shows the queue lengths during the PM period at the northern park and ride roundabout. The maximum queue observed is on the A12 northbound approach and is 42m (seven vehicles) in the Peak Construction scenario. The queues on the other approaches are low.

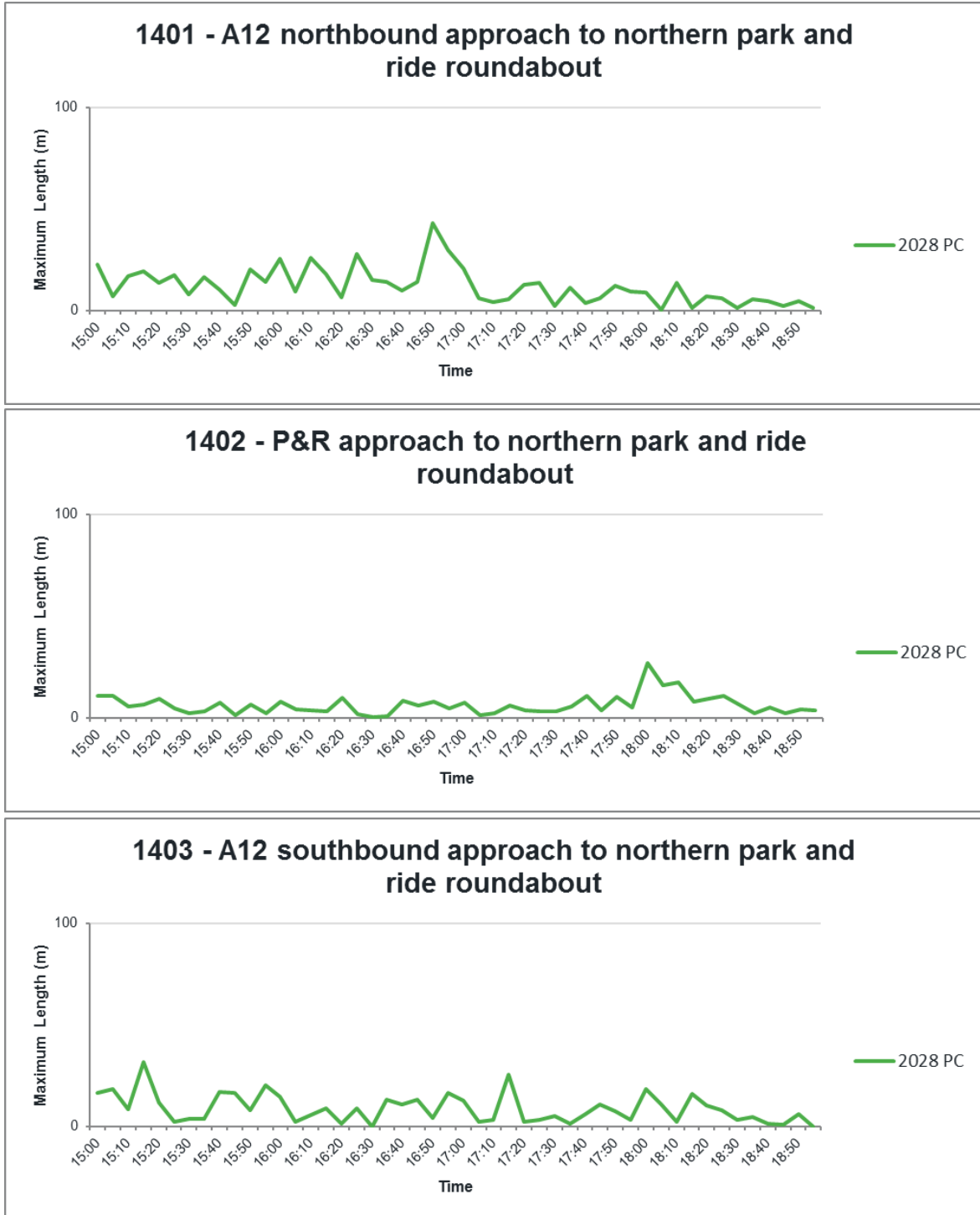

Figure 47 – Northern park and ride roundabout PM Queue lengths

6.2.31. The implementation of the roundabout results in a delay increase of 5 seconds on the A12 northbound and southbound movements in both scenarios. This level of delay is low and likely to be imperceptible.

PERFORMANCE SUMMARY

6.2.32. Journey times along the A12 are expected to increase by 13 seconds due to the extra vehicles on the network and the construction of the A12/B1122 and northern park and ride roundabouts.

6.2.33. The minor junctions in the study area do not experience a significant impact in their performance due to the addition of Sizewell C construction traffic. However, some impact is observed at the major junctions:

- The upgrade of the A12 / B1122 junction to a roundabout significantly reduces the level of delay at the B1122 approach, especially during the PM period. Even though the upgrade of the junction to a roundabout leads to a slight increase in delay on the A12, this remains low and the roundabout operates efficiently. The queues at the A12 northbound approach to the roundabout remain low in all scenarios and do not reach the upstream A1120 junction;
- The queue length on the A12 southbound approach to the A1120 junction is similar in the 2028 Reference Case and 2028 Peak Construction scenarios. The likelihood of the maximum queue reaching the upstream A12/B1122 junction is reduced compared to the Reference Case due to the increased stacking distance between the A1120 and B1122 because of the upgraded A12 / B1122 junction;
- The implementation of a roundabout for the northern park and ride site has a slight impact on queues and delays on the A12 approaches. However, these delays are minimal and the roundabout operates efficiently in the Peak Construction scenario.
- The maximum average queue on the A144 approach to the A12 increases moderately in Peak Construction scenario compared to the Reference Case during the AM period. This is due to the large increase in flow on the A144 approach due to Sizewell C. Queues in the PM peak are lower than the AM and are similar in the Reference Case and Peak Construction scenarios.

7. FORECAST SCENARIO – 2034 OPERATIONAL PHASE

7.1. SCENARIO ASSUMPTIONS

- 7.1.1. 2034 represents the normal operation of Sizewell C following construction. A total of 900 workers would be deployed at Sizewell C, all travelling from locations as predicted by the gravity model.
- 7.1.2. Following the completion of the construction of Sizewell C, the northern park and ride site would be removed and the original A12 T-junction with Willow Marsh Lane would be restored.
- 7.1.3. The proposed roundabout at the junction of the A12/B1122 would remain in place as would the upgraded A12/A144 junction.
- 7.1.4. The two mitigation measures proposed south of the modelled area would remain in place:
- A Two Village bypass at Farnham and Stratford St Andrew and
 - Sizewell Link Road, joining the A12 south of Yoxford to the B1122 east of Theberton.
- 7.1.5. The following daily HGV deliveries associated with Sizewell C will be made, on a typical day:
- To/from Sizewell C: 10 HGVs each way; and
 - To/from MasterLord Industrial Estate: 5 HGVs each way.
- 7.1.6. All SZC HGVs and buses will route via the A12, with those from the south using the proposed Sizewell Link Road. Those from the north would use the B1122 and join the Sizewell Link Road west of Middleton Moor.

TRANSPORT NETWORK ASSUMPTIONS

- 7.1.7. The 2034 Operational Phase scenario assumes two main changes in the network within the VISSIM model extent, compared to the Reference Case. The first one is the embedded mitigation at the A12 / B1122 junction, which is changed from a T-junction to a roundabout. Figure 35 shows how the junction was included in the model both before and after the mitigation implementation.
- 7.1.8. The second change in the transport network is the embedded mitigation at the A12 / A144 junction, where the T-junction has been upgraded from a ghost-island to a single lane dualling type of T-junction. Figure 37 shows the modelled A12 / A144 junction before and after its construction.
- 7.1.9. The detailed drawing of the mitigation measures can be found in Appendix F.

TRAFFIC DEMAND ASSUMPTIONS - 2034

VISSIM matrices

- 7.1.10. As in the 2023 and 2028 forecast scenarios, the base, growth and Sizewell C private vehicle traffic was included in the model as dynamically assigned matrices calculated from the VISUM model. The same method of extracting and calculating the forecast matrices for VISSIM has been used.
- 7.1.11. Sizewell C construction traffic was extracted from the 2034 Operational Phase VISUM model which assumed a total workforce of 900 workers.
- 7.1.12. Table 39 and Table 40 show the breakdown of total input matrix flows for the whole network by hourly time period for the Reference Case and Early Years scenarios respectively.

Table 39 – 2034 Network Traffic Reference Case (in vehicles per hour)

	6–7 am	7–8 am	8–9 am	3-4 pm	4-5 pm	5-6 pm	6-7 pm
Base 2034	515	1,149	1,368	1,525	1,593	1,449	1,086
Background Growth	237	309	307	383	273	367	331
Sizewell C	-	-	-	-	-	-	-
Total	752	1,458	1,676	1,908	1,866	1,816	1,417

Table 40 – 2034 Network Traffic Operational Phase (in vehicles per hour)

	6–7 am	7–8 am	8–9 am	3-4 pm	4-5 pm	5-6 pm	6-7 pm
Base 2034	503	1,122	1,318	1,485	1,559	1,407	1,055
Background Growth	238	311	303	372	265	352	319
Sizewell C	1	2	9	1	9	1	1
Total	742	1,434	1,630	1,857	1,833	1,760	1,375

Sizewell C HGV Deliveries

7.1.13. Table 41 shows the HGV deliveries per hour to the Sizewell C Master Lord Industrial Estate in the 2034 Operational Phase scenario. These HGVs were modelled as vehicle type “202: HGV SZC” and assigned to “Public Transport Lines” with fixed routes and equally spaced departure times.

Table 41 – 2034 Sizewell C HGV deliveries

Delivery Site	Direction	6-7am	7-8am	8-9am	3-4pm	4-5pm	5-6pm	6-7pm
Master Lord Industrial Estate	Inbound	0	1	0	0	0	0	0
	Outbound	0	0	1	0	0	0	0
Total		0	1	1	0	0	0	0

7.2. SCENARIO PERFORMANCE COMPARISON

7.2.1. This section presents the performance comparison between the validated base year scenario (“2015”), the Reference Case scenario for 2034 (“2034 RC”), and the 2034 Operational Phase scenario (“2034 OP”) with Sizewell C construction traffic.

NETWORK-WIDE PERFORMANCE

7.2.2. Table 42 shows a series of network-wide statistics that were extracted from the outputs of the four different scenarios.

Table 42 – Network Performance Model Results

	AM			PM		
	2015	2034 RC	2034 OP	2015	2034 RC	2034 OP
Total Time Taken (h)	275	354	353	499	624	615
Total Distance (km)	17,193	21,672	21,610	31,021	37,836	37,477
Total Vehicles	3,124	3,936	3,859	5,858	7,193	7,008
Total Delay (h)	24	36	36	46	68	64
Avg. Time (s) / Vehicle	317	324	329	307	312	316
Avg. Time (s) / Mile	93	95	95	93	96	95
Avg. Distance (m) / Vehicle	5,504	5,506	5,599	5,295	5,260	5,348
Avg. Speed (mph)	39	38	38	39	38	38
Avg. Speed (kph)	63	61	61	62	61	61
Avg. Delay / Vehicle (s)	28	33	33	28	34	33

- 7.2.3. During the AM and PM peaks, the network-wide statistics show that time, distance and delay have a linear relationship with the number of vehicles in the network. This means that the Sizewell C extra vehicles experience a similar time, distance and delay as the vehicles from the Reference Case and thus the network is not impacted.
- 7.2.4. Reviewing the relative statistics, it can be seen that the variation between the different scenarios is low. For example, the VISSIM model predicts that the average driver will experience no change in delay in the 2034 OP AM period scenario compared to the Reference Case whilst during the PM peak, the average delay per vehicle is decreased by 1 seconds (-3%).
- 7.2.5. This change in average delay is relatively low and hence does not have a significant impact in the network. The average speed throughout the network stays the same during both peak periods in the Operational Phase scenario compared to the Reference Case.
- 7.2.6. Figure 48 shows the average journey time along the A12 for each scenario.

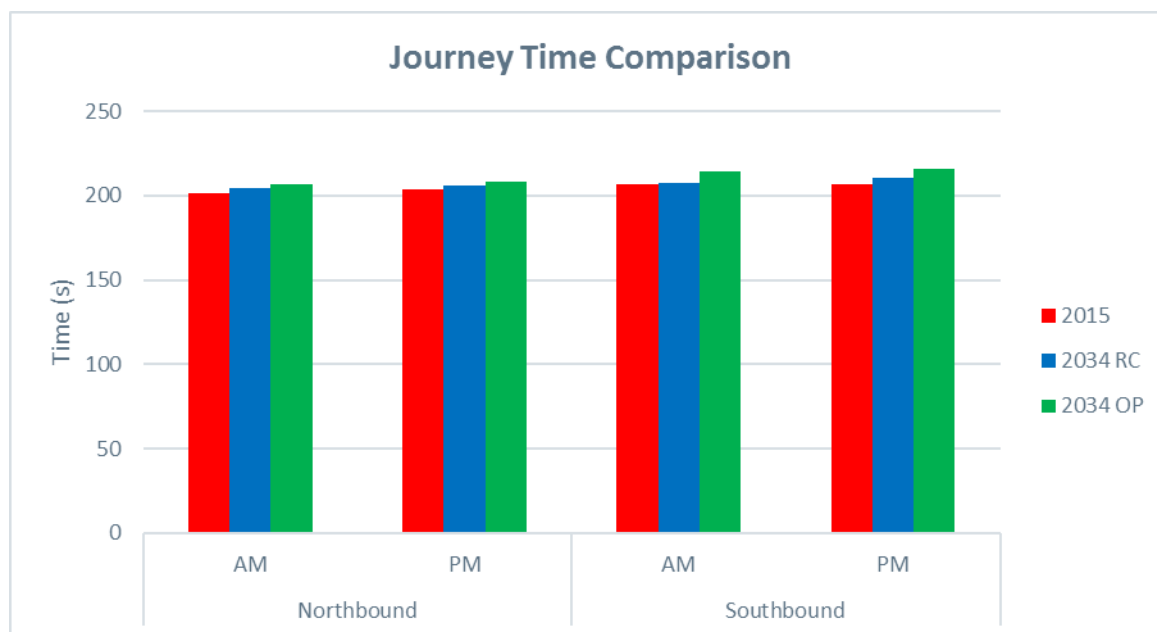

Figure 48 – 2034 Journey Time Comparison

7.2.7. The Operational Phase scenario has an average increase in journey time of 5 seconds compared to the Reference Case. This increase is mostly due to the introduction of both roundabouts (Northern park and ride site access and B1122 roundabout) along the A12, which add slight delay to the A12 movements. As the daily variation in travel times is likely to exceed a difference of 5 seconds per vehicle, it is unlikely that a change of this magnitude would be perceptible to A12 road users.

JUNCTION PERFORMANCE

7.2.8. Queue and average delay results have been collected for all junctions in the model in order to assess the performance of each junction.

7.2.9. Figure 49 shows the average delay for each junction over the whole AM and PM periods. The values shown below represent the average of all turning movements in the junction.

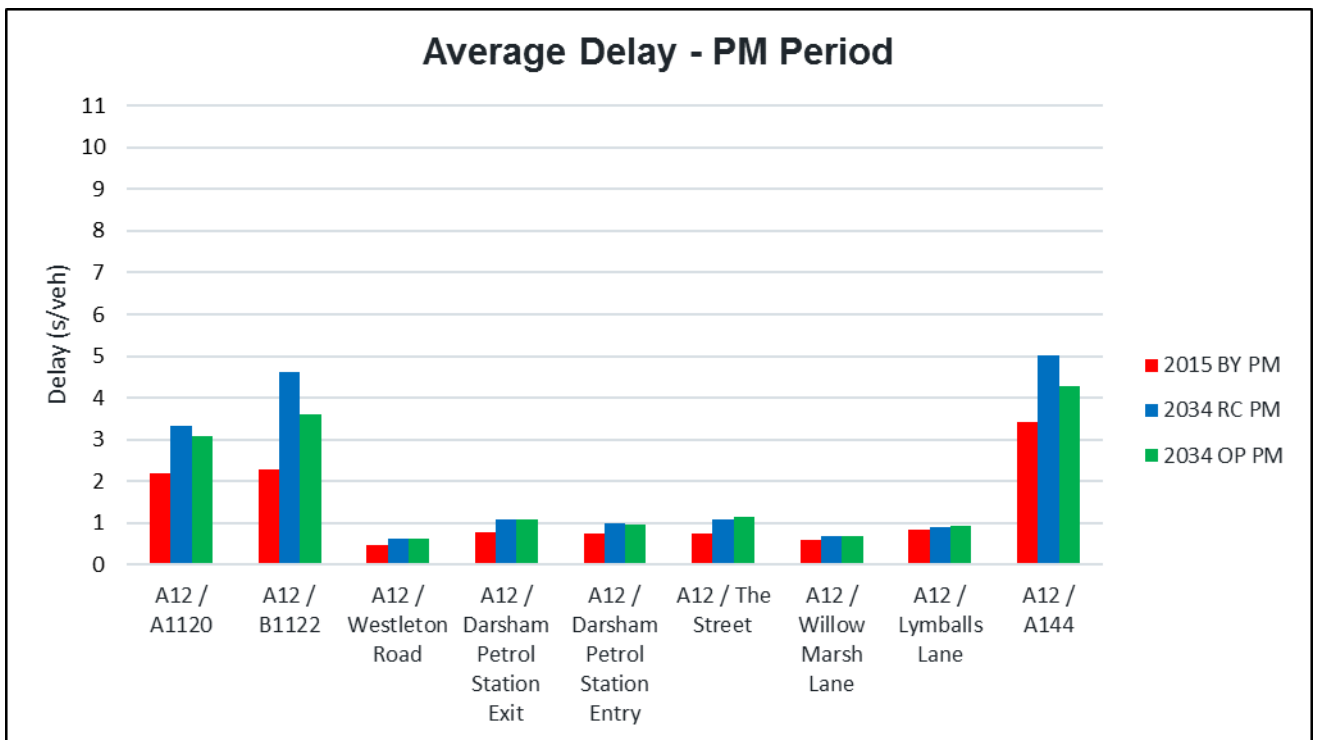
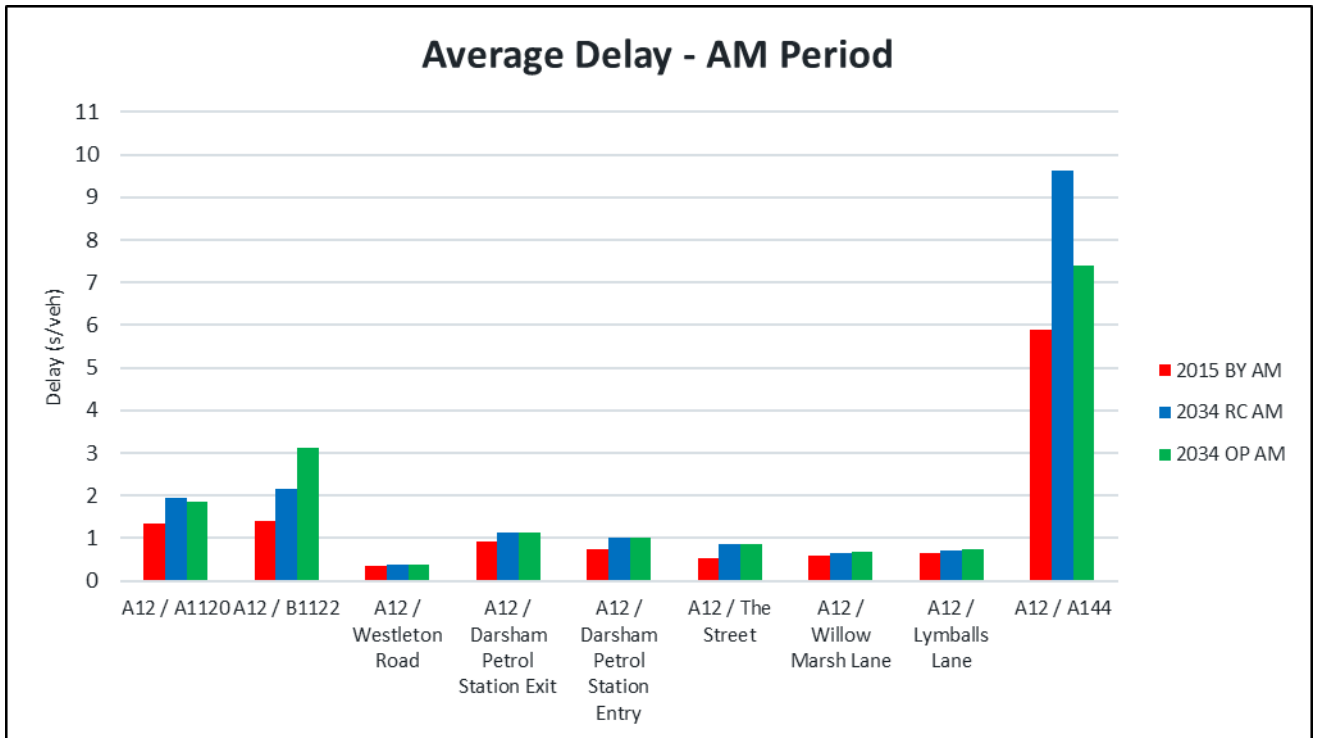

Figure 49 – Junction Average Delay

7.2.10. The graphs show that the level of delay is low at the A12 junctions with Westleton Road, Darsham Petrol Station, The Street, Willow Marsh Lane and Lymballs Lane. A higher level of delay is observed at the A12 / A1120, A12 / B1122 and A12 / A144 junctions. The addition of Sizewell construction traffic does not have a significant impact on any of the junctions. The A12 / B1122

junction upgrade to a roundabout leads to improvements in delay during the PM period. The improvements at the A12 / A144 junction lead to reduced delay in both peak periods.

7.2.11. Detailed results analysis is provided below for the main junctions in the network; A12 / A1120, A12 / B1122 and A12 / A144. The graphs shown below represent the maximum queue recorded during each 5-minute period, averaged over each iteration by scenario. A full set of queue graphs can be found in Appendix E.

A12 / A1120

7.2.12. Figure 50 shows the queue lengths during the AM period at the A12 / A1120 junction. The right-turn queues from the A12 southbound approach are predicted to be very similar in the Reference Case and Operational Phase. The queues on the High Street remain low during the entire modelled period in all scenarios.

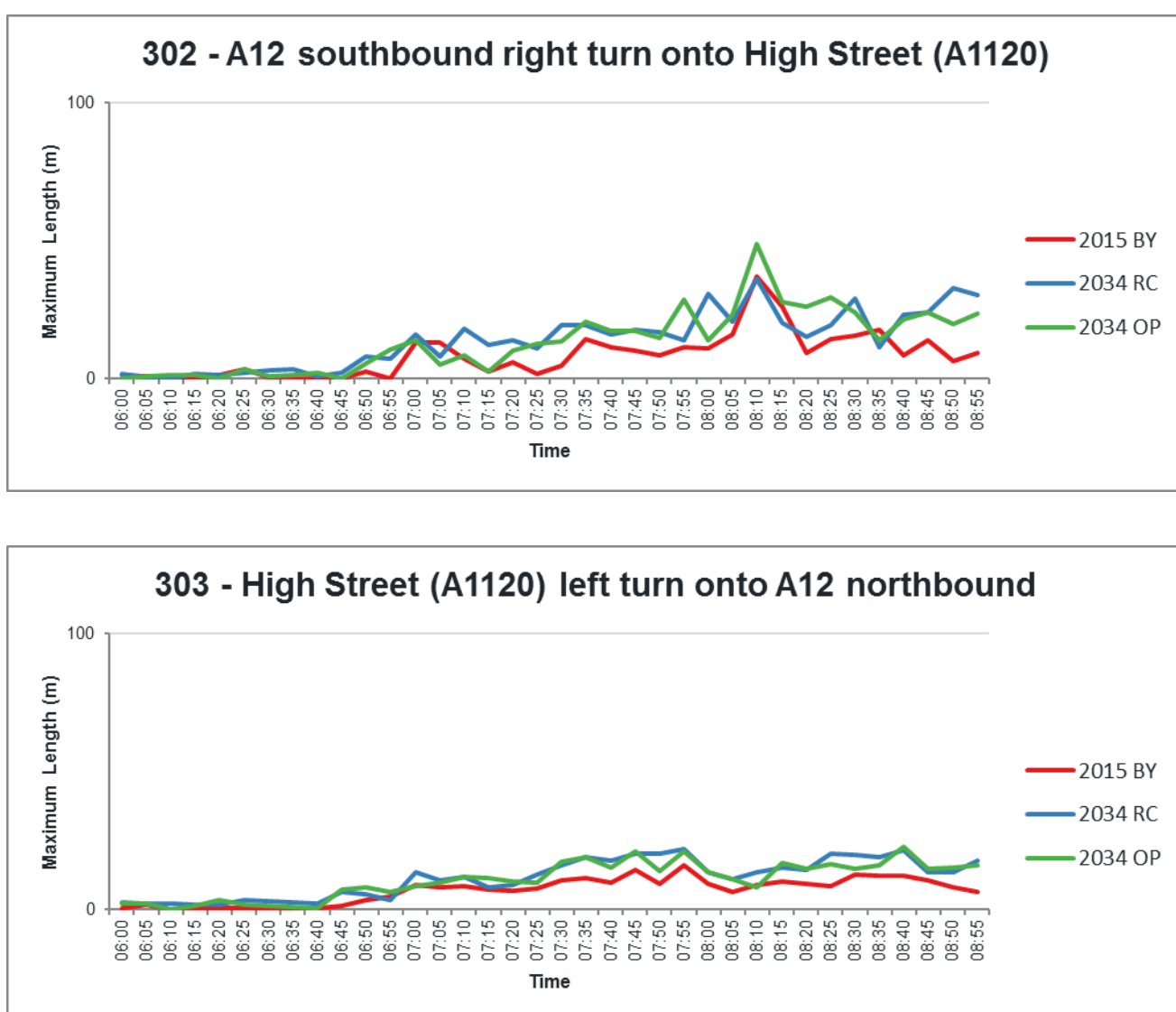

Figure 50 – A12 / A1120 AM Queue lengths

7.2.13. Due to the proximity between the A12 / A1120 and A12 / B1122 junctions, a more detailed analysis has been performed on the A12 southbound approach (queue counter #302) to determine whether the queue reaches the B1122 junction. As a result of the upgrade of the A12 / B1122 junction to a roundabout in the Operational Phase scenario, the stacking distance between the B1122 and A1120 junctions is increased from 150m (current layout) to 230m. Table 43 shows that the queue from the right turn into the A1120 doesn't reach the B1122 junction in the either scenario.

Table 43 – A12 / A1120 queue spillback analysis – AM period

Scenario	Stacking distance between A12 / A1120 and A12 / B1122 (m)	Percentage of runs where queue reaches A12/B1122 junction (%)	Length of time during which queue reaches A12/B1122 junction	Absolute maximum queue (m)
2034 Reference Case	150	0	-	86
2034 Operational Phase	230	0	-	121

7.2.14. Figure 51 shows the queue lengths during the PM period at the A12 / A1120 junction. The queue lengths are similar or slightly shorter in the Operational Phase compared to the Reference Case.

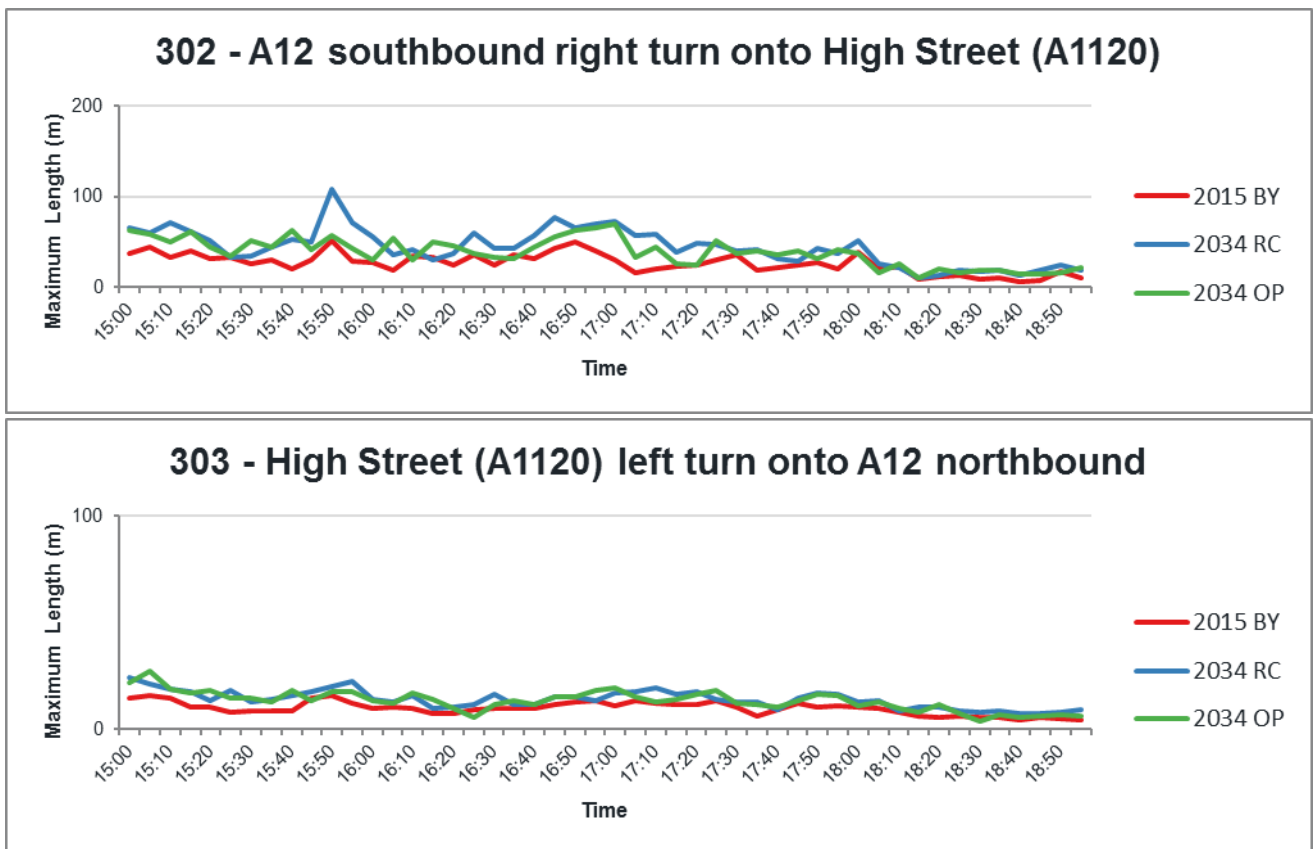

Figure 51 – A12 / A1120 PM Queue lengths

7.2.15. Due to the proximity between the A12 / A1120 and A12 / B1122 junctions, a more detailed analysis has been undertaken on the A12 southbound approach (queue counter #302) to determine the impact on the upstream junction, shown in Table 44. As a result of the upgrade of the A12 / B1122 junction to a roundabout in the Operational Phase scenario, the stacking distance between the B1122 and A1120 junctions is increased from 150m (current layout) to 230m. Table 43 shows that the queue from the right turn into the A1120 doesn't reach the B1122 junction in the Operational Phase scenario

Table 44 – A12 / A1120 queue spillback analysis – PM period

Scenario	Stacking distance between A12 / A1120 and A12 / B1122 (m)	Percentage of runs where queue reaches A12/B1122 junction (%)	Length of time during which queue reaches A12/B1122 junction	Absolute maximum queue (m)
2034 Reference Case	150	50	< 5 min	244
2034 Operational Phase	230	0	-	218

A12 / B1122

7.2.16. Figure 52 shows the queue lengths during the AM period at the A12 / B1122 junction. This junction was modelled as a T junction in the 2015 and 2034 RC scenarios and as a roundabout in the 2034 Operational Phase scenario. The graph indicates that the queue lengths in the Operational Phase scenario remains very low on the A12 northbound approach. There would be some queuing on A12 southbound approach due to the introduction of the roundabout but the maximum queue length is only 40m (seven vehicles). This queuing would occur on the approach to Yoxford, rather than in the village itself. On the B1122 the queue length is shorter in the Operational Phase scenario due to the introduction of the roundabout.

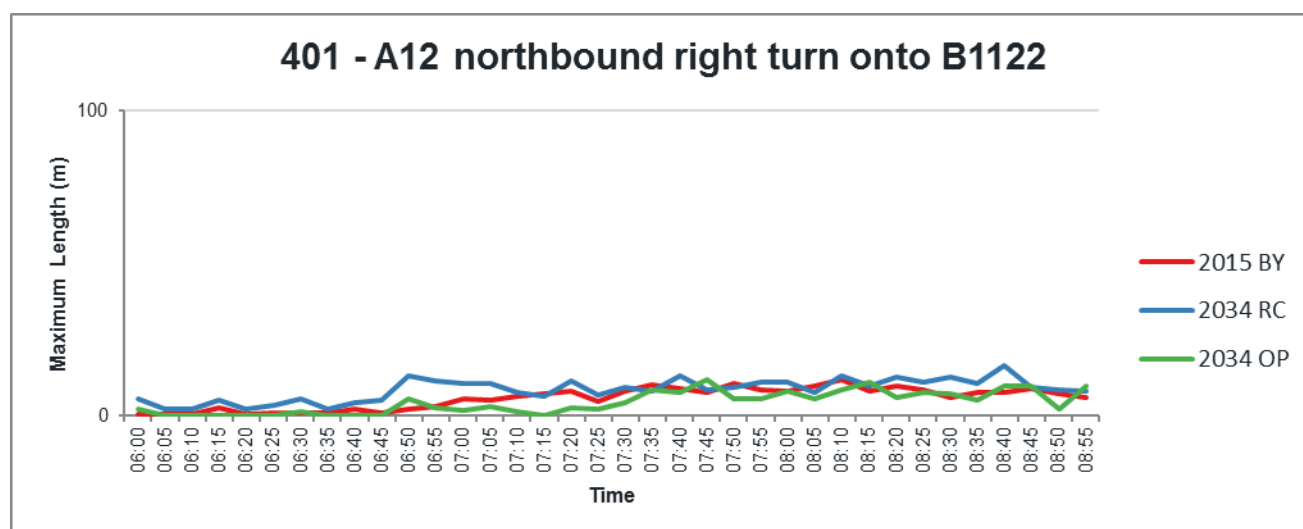

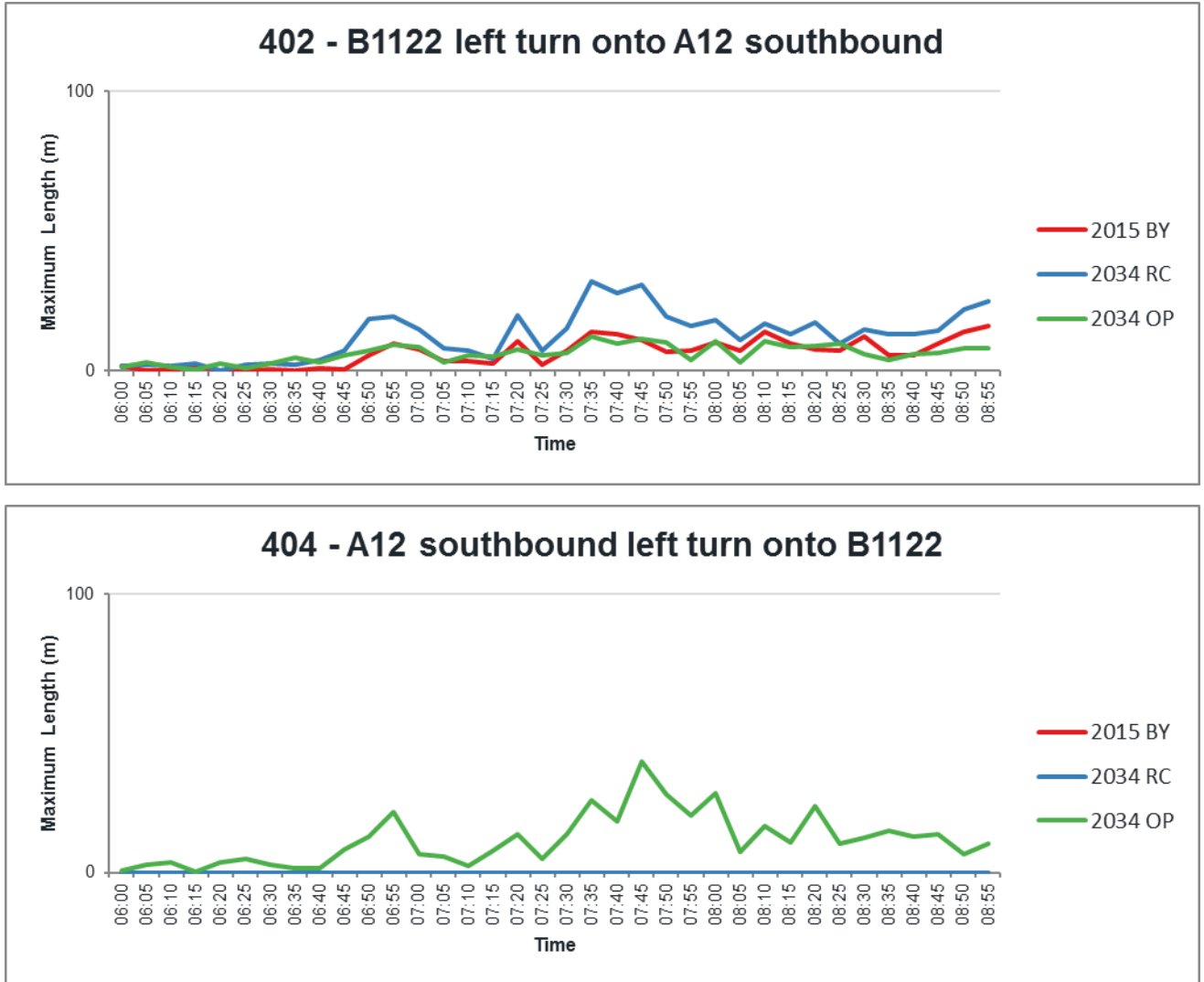

Figure 52 – A12 / B1122 AM Queue lengths

7.2.17. Due to the proximity between the A12 / A1120 and A12 / B1122 junctions, a more detailed analysis has been performed on the A12 northbound approach (queue counter #401) to determine the impact on the upstream A1120 junction, shown in Table 45. This table shows that the upstream A1120 junction would not be blocked in any of the scenarios and the absolute maximum queue is far from reaching the A1120 junction.

Table 45 – A12 / B1122 AM spillback analysis

Scenario	Stacking distance between A12 / A1120 and A12 / B1122 (m)	Percentage of runs where queue reaches A1120 junction (%)	Length of time during which queue reaches A1120 junction	Absolute maximum queue (m)
2034 Reference Case	150	0	-	64
2034 Operational Phase	230	0	-	66

- 7.2.18. Due to the change of the A12/B1122 junction from a T-junction to a roundabout, the arms experiencing queues are different to those in the Reference Case. Thus, additional analysis on the delay during the most congested hour (08:00-09:00) is shown in Table 46.
- 7.2.19. There is a reduction in delay at the junction, most significantly on the B1122 approach. The slight increase in delay on the A12 southbound remains low and is not significant.

Table 46 – A12 / B1122 AM maximum delay analysis

	Movement Delay (s/veh) 08:00 – 09:00					
	A12 S – A12 N	A12 S – B1122	A12 N – A12 S	A12 N – B1122	B1122 – A12 S	B1122 – A12 N
2034 Reference Case	0	6	1	1	8	25
2034 Operational Phase	2	3	5	3	4	6

- 7.2.20. Figure 53 shows the queue lengths during the PM period at the A12 / B1122 junction. Due to the introduction of the roundabout in the Operational Phase scenario, the queue lengths are significantly lower than the Reference Case on the B1122 approach. They do however increase on the A12 approaches, with a maximum queue on the southbound approach of 55m (nine vehicles). Despite this queue, the junction does operate effectively in all scenarios. Queues dissipate quickly and are generally moving rather than stationary so little impact is felt at this location.

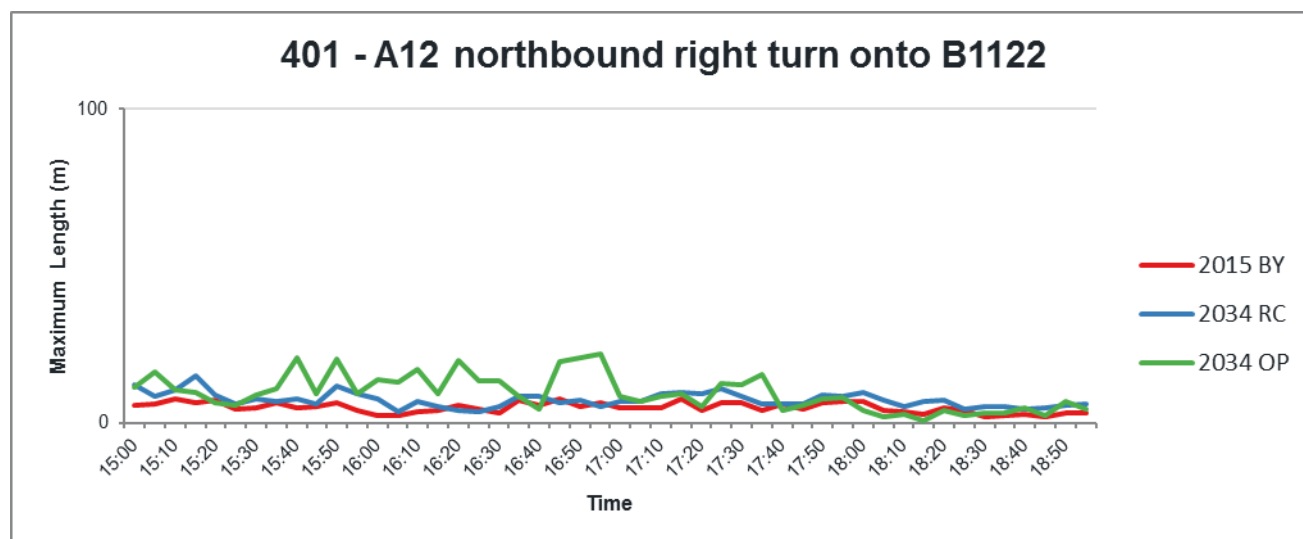

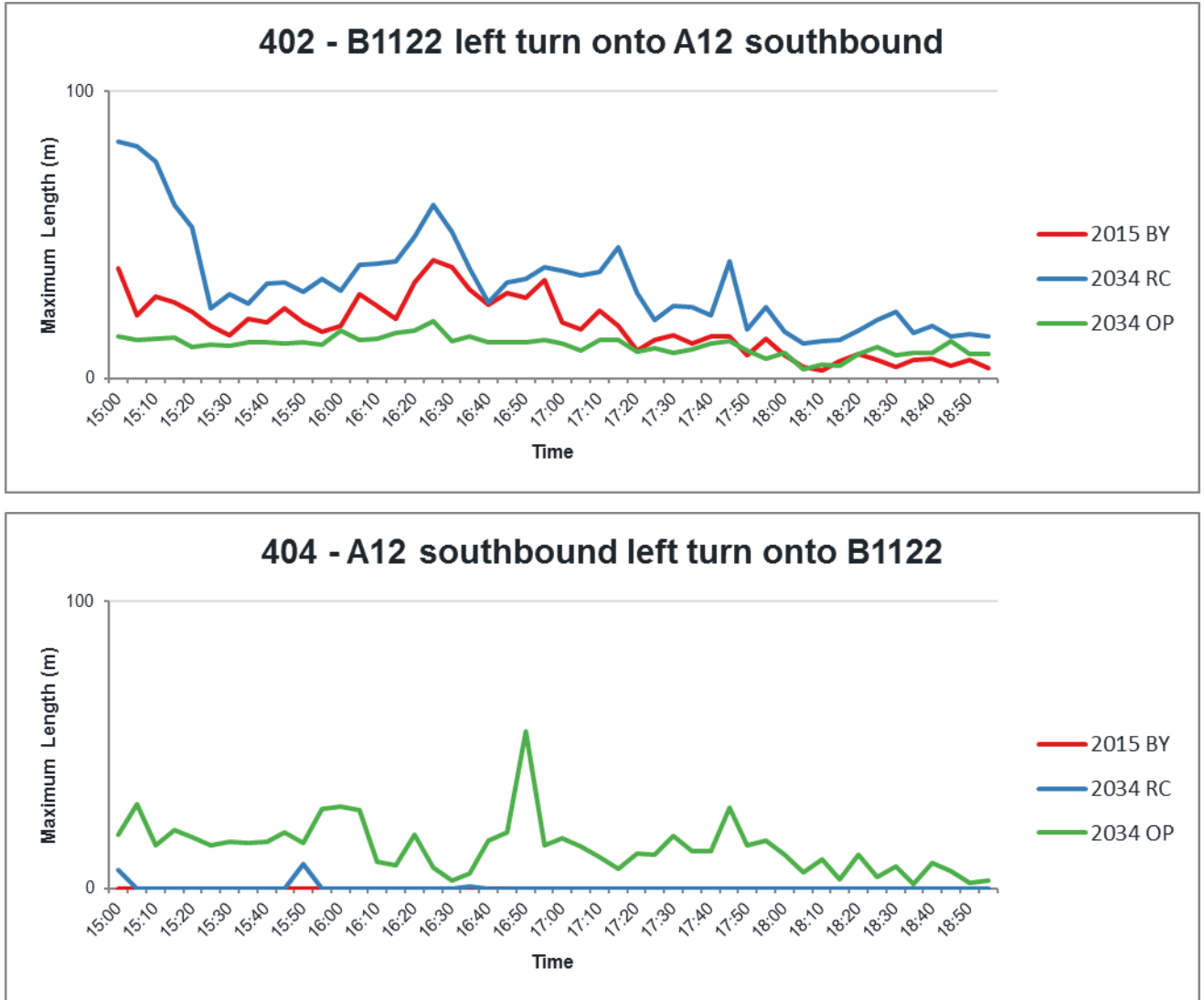

Figure 53 – A12 / B1122 PM Queue lengths

7.2.21. Due to the proximity between the A12 / A1120 and A12 / B1122 junctions, a more detailed analysis has been performed on the A12 northbound approach (queue counter #401) to determine the impact on the upstream A1120 junction, shown in Table 47. The table shows that the A12 northbound queue doesn't reach the A1120 junction in any of the scenarios and the absolute maximum queue does not reach this location.

Table 47 – A12 / B1122 queue spillback analysis – PM period

Scenario	Stacking distance between A12 / A1120 and A12 / B1122 (m)	Percentage of runs where queue reaches A1120 junction (%)	Length of time during which queue reaches A1120 junction	Absolute maximum queue (m)
2034 Reference Case	150	0	-	37
2034 Operational Phase	230	0	-	77

- 7.2.22. Due to the change of the A12/B1122 junction from a T-junction to a roundabout, the location of the queues at the approaches have changed. Thus, an additional analysis on the delay during the most congested hour (16:00 – 17:00) is shown in Table 48.
- 7.2.23. The level of delay experienced on the B1122 approach to the existing A12 junction in the Reference Case scenario during the PM period is significant. As a result of the upgrade to a roundabout, the B1122 traffic delay is reduced from 20s for southbound traffic and 35s for northbound traffic to 5-8s per vehicle. On the other hand, the delay on the A12 is slightly increased, but still remains low.

Table 48 – A12 / B1122 PM maximum delay analysis

	Movement Delay (s/veh) 16:00 – 17:00					
	A12 S – A12 N	A12 S – B1122	A12 N – A12 S	A12 N – B1122	B1122 – A12 S	B1122 – A12 N
2034 Reference Case	0	6	1	1	20	35
2034 Operational Phase	2	4	5	3	5	8

A12 / A144

- 7.2.24. Figure 54 shows the queue lengths during the AM period at the A12 / A144 junction. The second graph shows that the queue length at the A144 approach has slightly shorter queues in the Operational Phase when compared to the Reference Case. On the A12 southbound approach the queues are small in all scenarios.

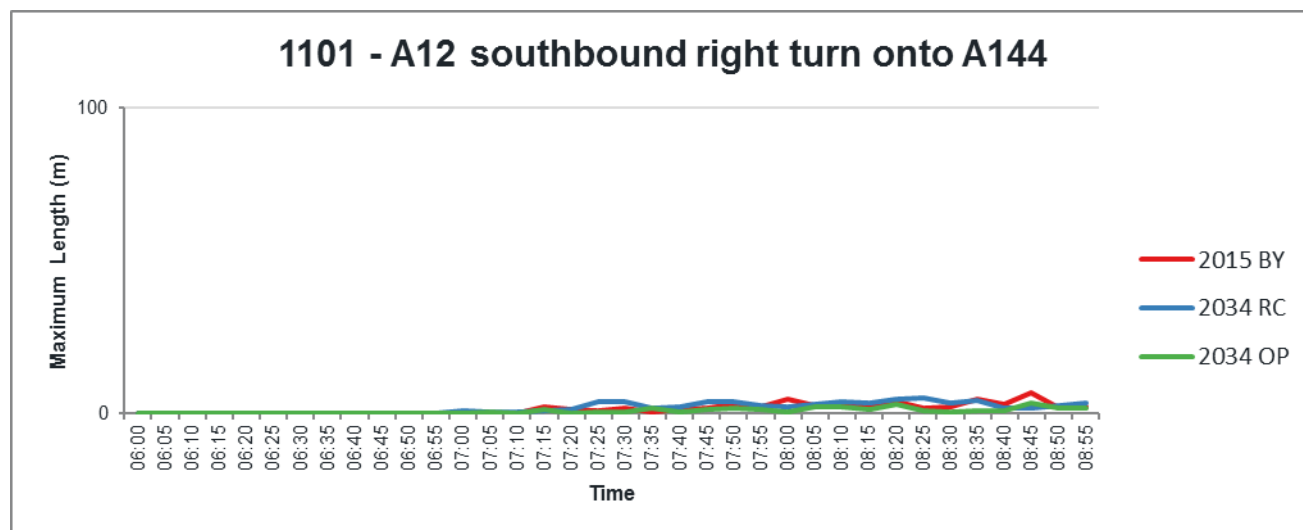

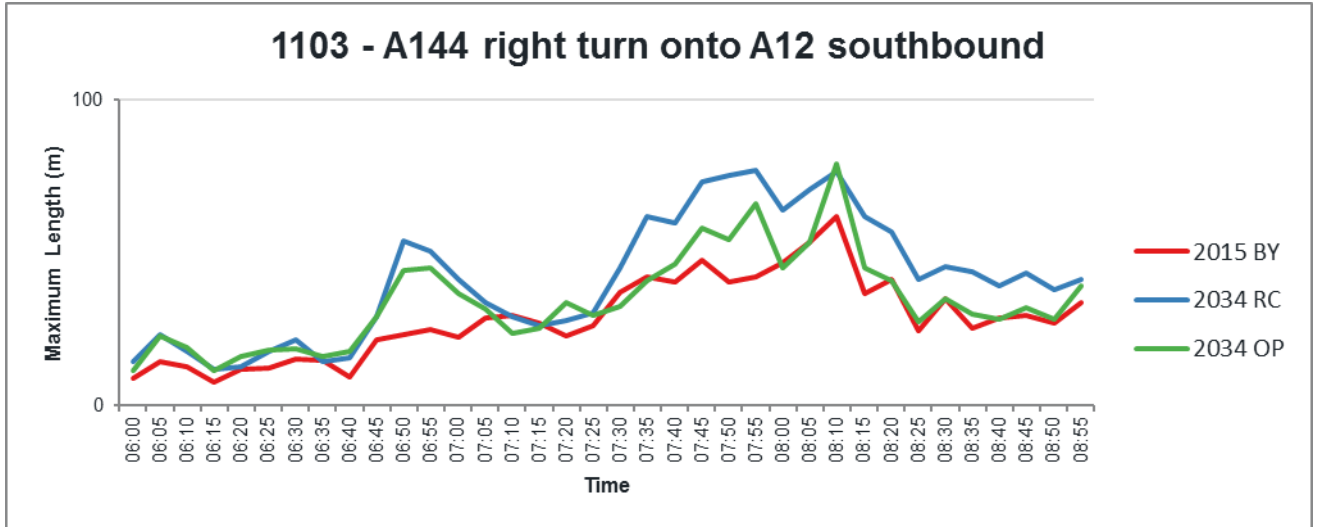
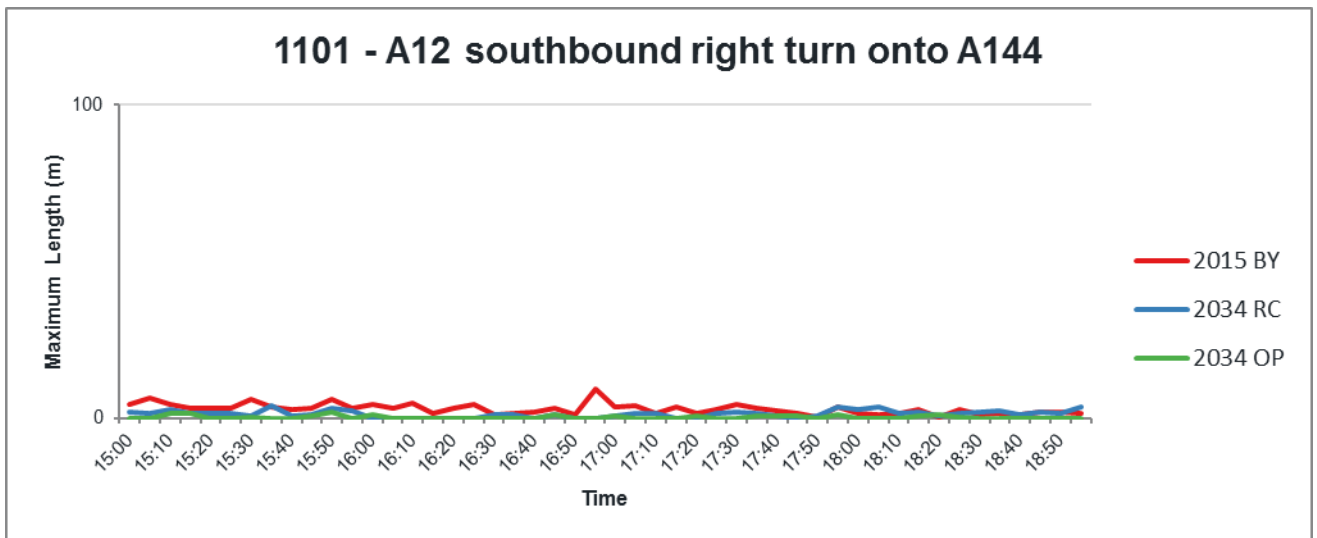

Figure 54 – A12 / A144 AM Queue lengths

7.2.25. Figure 55 shows the queue lengths during the PM period at the A12 / A144 junction. As in the AM period, there is little queuing on the A12 southbound right-turn lane during the PM period. The queues on the A144 are similar or slightly shorter in the Operational Phase scenario compared to the Reference Case and are shorter overall than in the AM period.



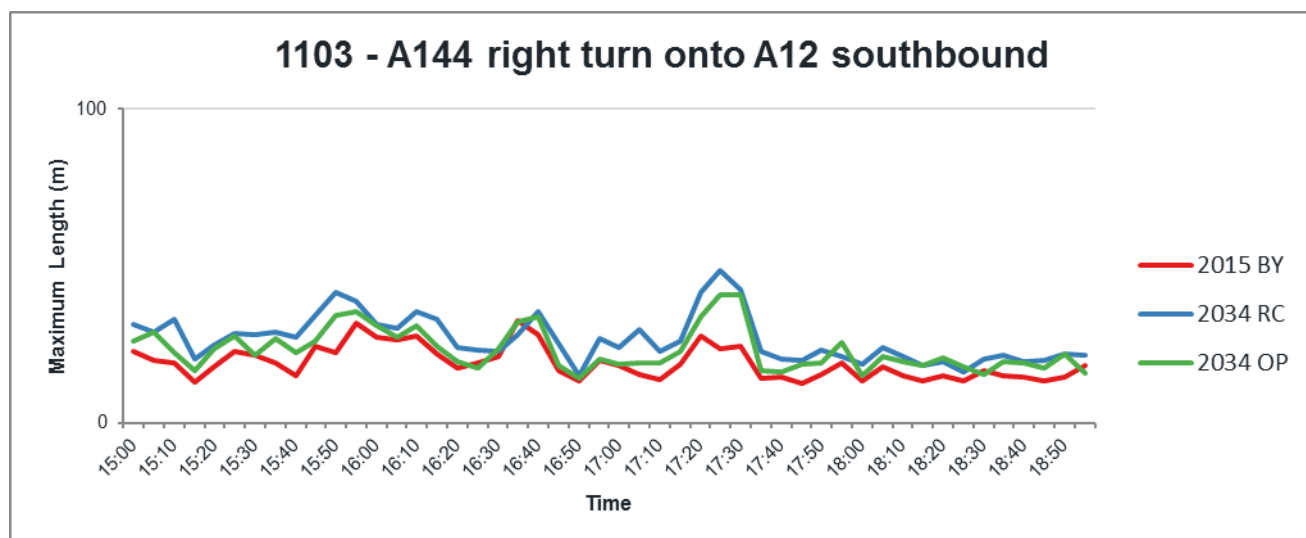

Figure 55 – A12 / A144 PM Queue lengths

PERFORMANCE SUMMARY

7.2.26. The impact of the Sizewell C construction traffic in the Operational Phase scenario on the network around Yoxford in 2034 is reasonably low.

7.2.27. The minor junctions in the study area do not experience a significant impact in their performance due to the addition of Sizewell C construction traffic. However, a small amount of impact is observed at the major junctions:

- The upgrade of the A12 / B1122 junction to a roundabout significantly reduces the level of delay at the B1122 approach, especially during the PM period. Even though the upgrade of the junction to a roundabout results in slight increases in delay on the A12, these remain low and the roundabout operates efficiently. The queues at the A12 northbound approach to the roundabout remain low in all scenarios and never reach the upstream A1120 junction;
- The average queues on the A12 southbound approach to A1120 are similar in the Reference Case and Operational Phase. The likelihood of this queue reaching the upstream A12/B1122 junction is reduced in the Operation Phase scenarios as the new roundabout would be placed further north;
- The average queues on the A144 approach to the A12 show a similar or small decrease in the Operational Phase compared to the Reference Case.

8. CONCLUSIONS

- 8.1.1. The VISSIM model provides a robust evidence base which has been used to assess the operational performance of the network in 2023, 2028 and 2034 with and without the Sizewell C construction traffic. Key conclusions from the study are set out below.

2023 Early Years

- 8.1.2. The addition of Sizewell C vehicle trips in the 2023 Early Years scenario during the AM and PM period on the local road network in Yoxford does result in some temporary localised impacts.
- 8.1.3. The right turn queue from the A12 southbound onto the A1120 during the PM peak is predicted to occasionally reach back to the upstream B1122 junction. However, any queues reaching the B1122 are predicted to be present for no more than five minutes before dissipating and are therefore unlikely to have a significant impact on delays.
- 8.1.4. Relative to the Reference Case, queues and delay on the B1122 approach to the A12 during the AM and PM periods increase for short periods, although the junction still operates within capacity as queues do not continue to propagate during the modelled period. If it is found that the Sizewell C traffic has an impact on the performance of the B1122 minor arm in 2023, it may be possible to provide additional bus services to/from Sizewell C prior to the provision of the proposed roundabout scheme by 2028.
- 8.1.5. Relative to the Reference Case, queues on the A144 approach to the A12 increase slightly during parts of the AM period, but do not impact the overall junction performance.

2028 Peak Construction

- 8.1.6. The Sizewell C additional vehicle trips in the 2028 Peak Construction scenario have some impact on the local road network around Yoxford. Journey times along the A12 and congestion levels are increased, but the increase is unlikely to be outside of daily variation and therefore not perceptible.
- 8.1.7. The maximum queue on the A12 southbound approach to the A1120 junction increases slightly during the AM Peak due to the additional Sizewell C traffic. However, the likelihood of this queue reaching the upstream B1122 junction is lower because of the presence of the provision of the B1122 roundabout which provides an increased stacking distance between the A11220 and B1122.
- 8.1.8. Due to the proposed A12 / B1122 roundabout, delays are significantly reduced on the B1122 approach relative to the Reference Case, especially during the PM period. Even though the junction upgrade is predicted to result in slight increases in delay on the A12, delay per vehicle is predicted to remain low and the roundabout is forecast to operate efficiently with minimal queues. Queues on the A12 northbound approach to the B1122 remain low in all scenarios and are unlikely to reach the upstream A1120 junction.
- 8.1.9. The proposed new roundabout for the northern park and ride site has a slight impact on queues and delays on the A12 approaches in the Peak Construction scenario, however these delays are low and the roundabout is predicted to operate efficiently.
- 8.1.10. Queue lengths and delays are expected to increase moderately on the A144 approach to the A12 in the AM peak during the Peak Construction scenario due to an increase in flows on this approach. The maximum queues on the minor arm (A144) are expected to occur from 06:45 - 08:00 and is likely to reach approximately 12 vehicles in length in the 2028 Reference Case and up to 14 vehicles

in length in the Peak Construction scenario. During the other morning periods and throughout the afternoon periods the queues in the Peak Construction scenario are broadly similar to the 2028 Reference Case scenario.

- 8.1.11. The average delay per vehicle on the A144 approach increases during the morning periods in the 2028 Peak Construction scenario compared to the 2028 Reference Case due to the increase in flows. The largest increase in delay is found from 07:00-08:00, resulting in an average delay of 41s (Level of Service E) in the 2028 Peak Construction scenario compared to 31s (Level of Service D) in the 2028 Reference Case scenario. This is an increase of 10 seconds per vehicle on average which is likely to be within daily variation.
- 8.1.12. Whilst VISSIM suggests that the proposed mitigation scheme does not mitigate all of the impact caused by the additional Sizewell C traffic it is likely to improve throughput and safety at this location. Due to the additional complexity of the give-way behaviour between those waiting to use the central reservation and those already using it, the single lane dualled layout is more difficult to represent in VISSIM. The VISSIM model setup for the single lane dualled layout is considered to be more conservative in the way that the give-way behaviour rules are applied compared to the ghost island layout. The Peak Construction results are therefore felt to be a worst case and the A144 minor arm is likely to perform better than predicted by VISSIM.

2034 Operational Phase

- 8.1.13. The impact of the Sizewell C traffic in the 2034 Operational Phase is relatively low. Journey times along the A12 are predicted to increase slightly but not outside of daily variation and are therefore unlikely to be noticeable.
- 8.1.14. The junction improvements at the A12 / B1122 and A12 / A144 reduce queues at these locations in the Operational Phase compared to the Reference Case. At the A12 / A1120 junction, queues are similar to the Reference Case.

9. LIMITATIONS

- 9.1.1. The VISSIM modelling carried out for this assessment is based on traffic count and queue length data collected on a single day. It aims to represent a typical day through its validation against journey time data that has been collected over a number of days. It does not reflect unusual or periodic fluctuations in traffic demand or traffic conditions.
- 9.1.2. The VISSIM model has been developed for the purposes of assessing the impacts of additional traffic demand generated by the Sizewell C project, as well as associated proposed highway improvements. The level of detail within the model is proportionate to its purpose.

Appendix A

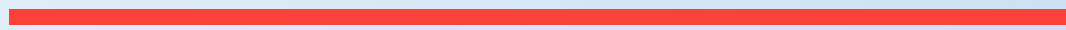

NETWORK TRAFFIC FLOW DIAGRAMS

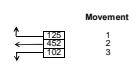
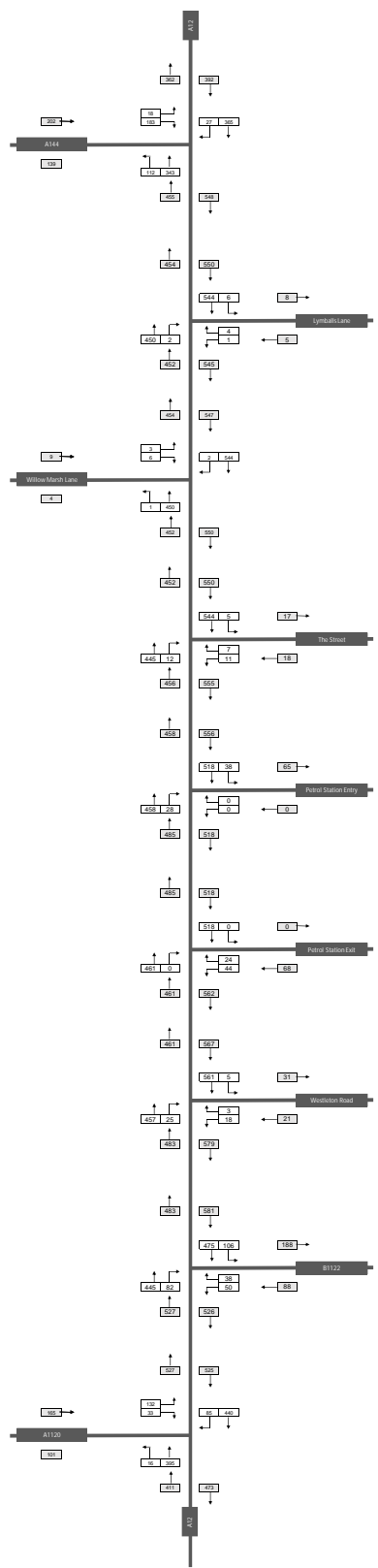
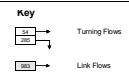

Title: 2015 AM Base Year	Client: EDF	Date: 24/09/2019
Time Period: 08:00 - 09:00	Project: Sizewell C	Reference: 50400326



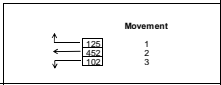

Title	Client	Date
2015 IP Base Year	EDF	24/09/2019
Title Period	Project	Reference
15:00 - 16:00	Sizewell C	50400326



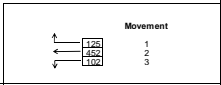
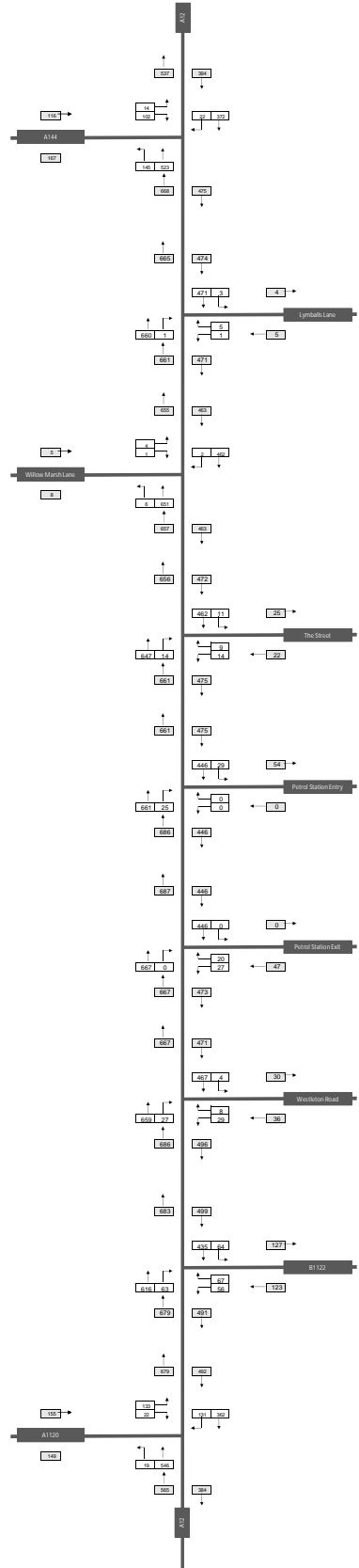

Title	Client	Date
2015 PM Base Year	EDF	24/09/2019
Time Period	Project	Reference
17:00 - 18:00	Sizewell C	50400326



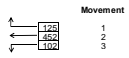
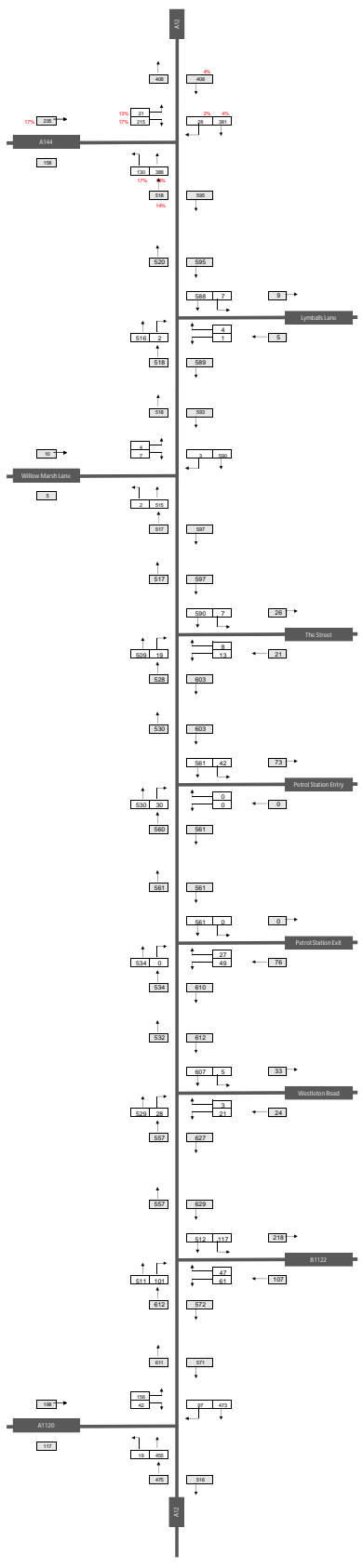
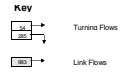

Title:	Date:	Site:
2023 RC AM	EDF	24/09/2019
Time Period:	Project:	Reference:
08:00 - 09:00	Sizewell C	50400326



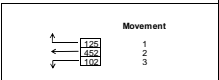
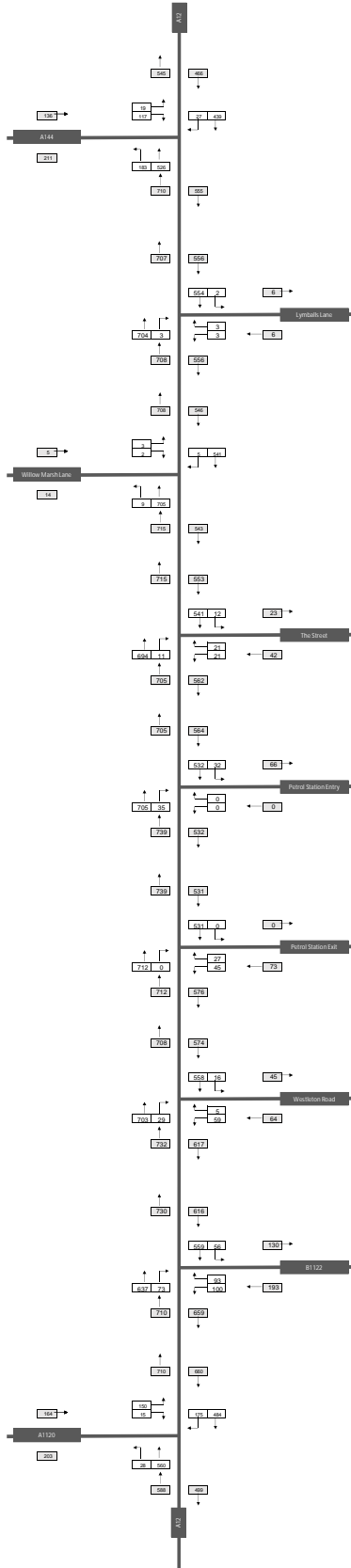

Title	Client	Date
2023 RC IP	EDF	24/09/2019
Time Period	Project	Reference
15:00 - 16:00	Sizewell C	50400326



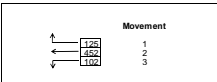

Title	Client	Date
2023 RC PM	EDF	24/09/2019
Time Period	Project	Reference
17:00 - 18:00	Sizewell C	50400326



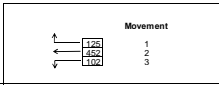
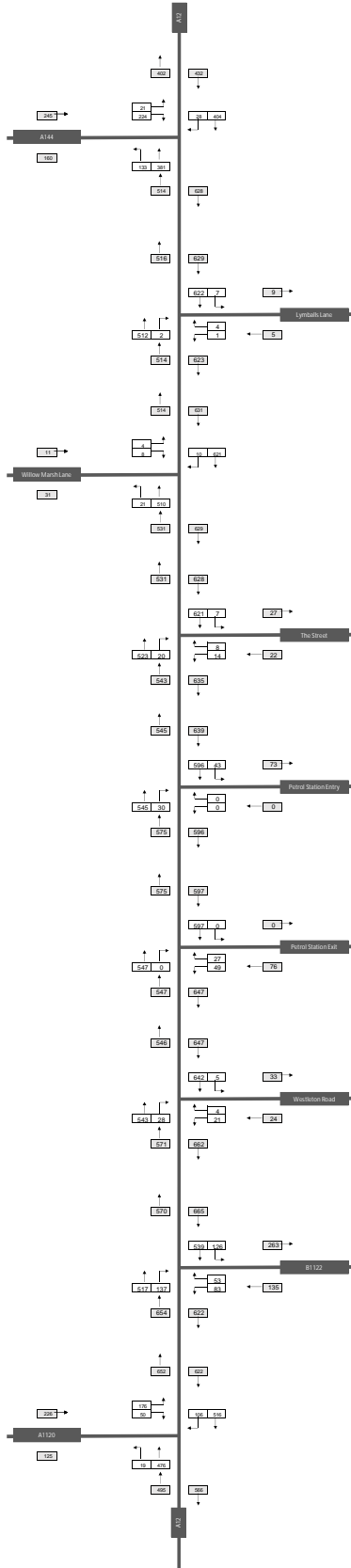

Title: 2023 EY AM	Client: EDF	Date: 24/09/2019
Time Period: 08:00 - 09:00	Project: Sizewell C	Reference: 50400326



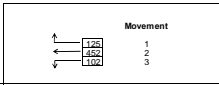
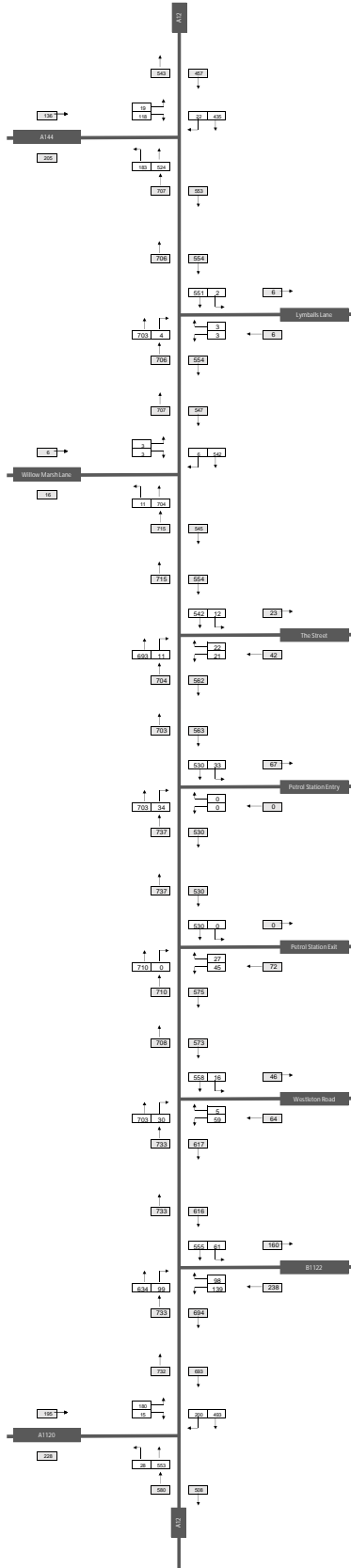

Title	Client	Date
2023 EY IP	EDF	24/09/2019
Time Period	Project	Reference
15:00 - 16:00	Sizewell C	50400326



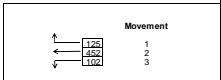
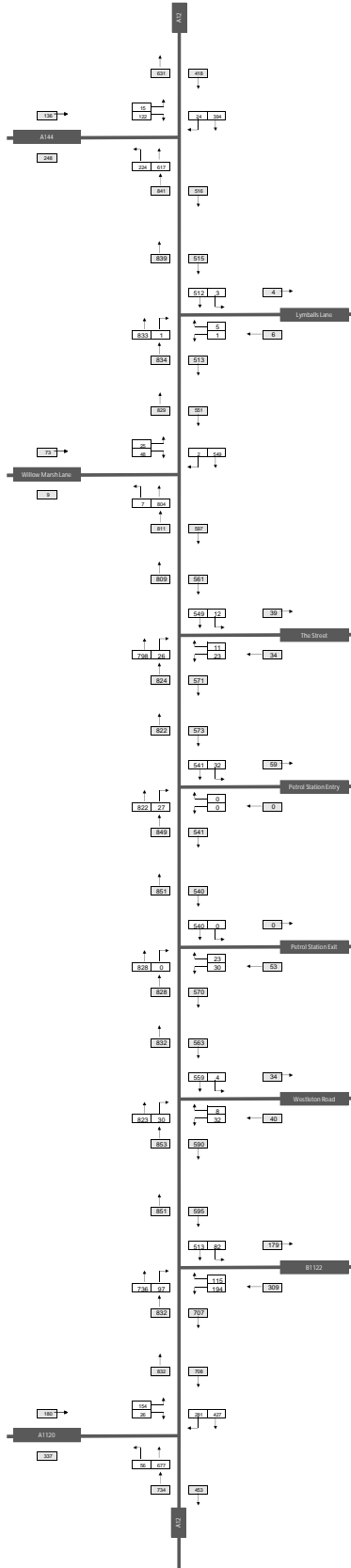

Title: 2023 EY PM	Client: EDF	Date: 24/09/2019
Time Period: 17:00 - 18:00	Project: Sizewell C	Reference: 50400326



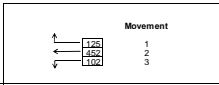
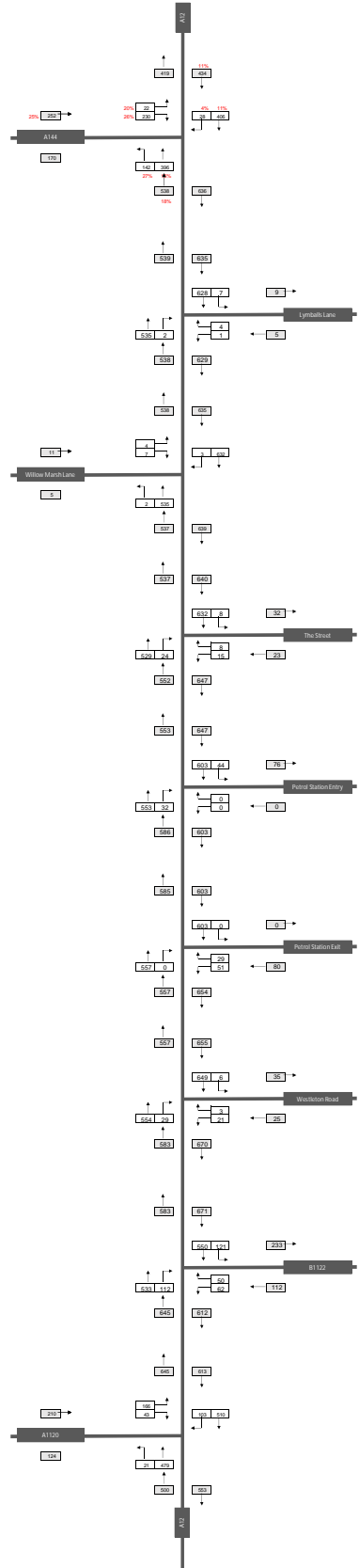

Site:	Client:	Date:
2028 RC AM	EDF	24/09/2019
Time Period:	Project:	Reference:
08:00 - 09:00	Sizewell C	50400326



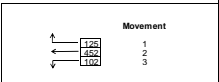
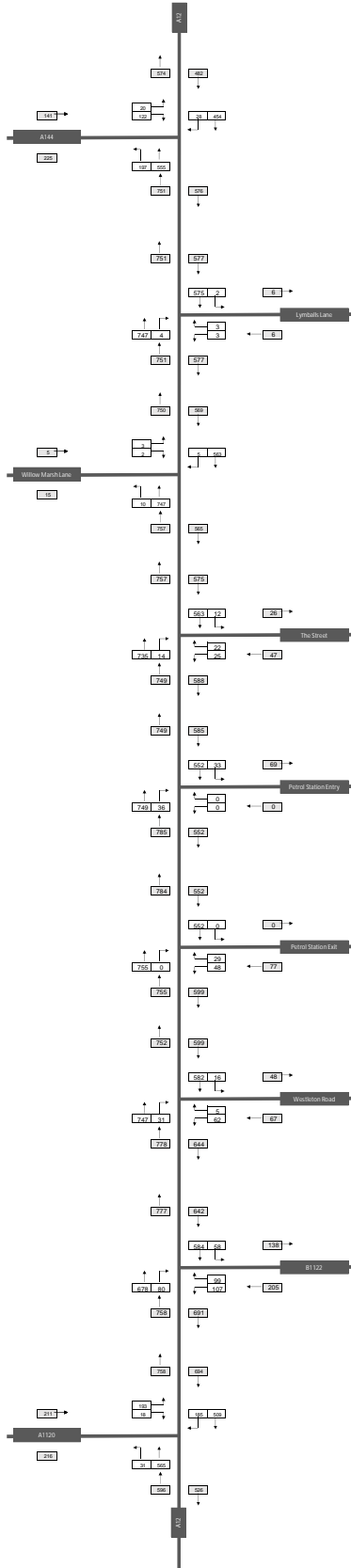

Title	Client	Date
2028 RC IP	EDF	24/09/2019
Time Period	Project	Reference
15:00 - 16:00	Sizewell C	50400326

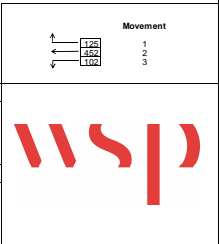

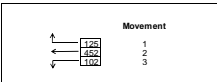
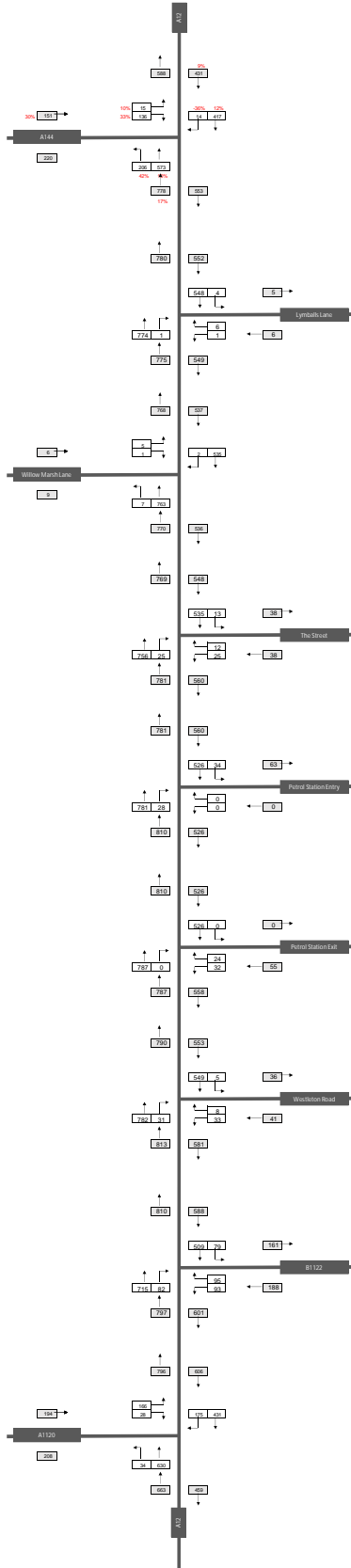

Title	Client	Date
2028 RC PM	EDF	24/09/2019
Time Period	Project	Reference
17:00 - 18:00	Sizewell C	50400326

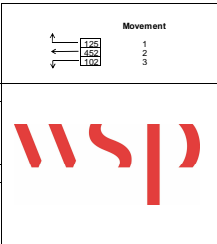

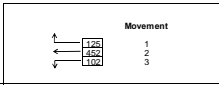
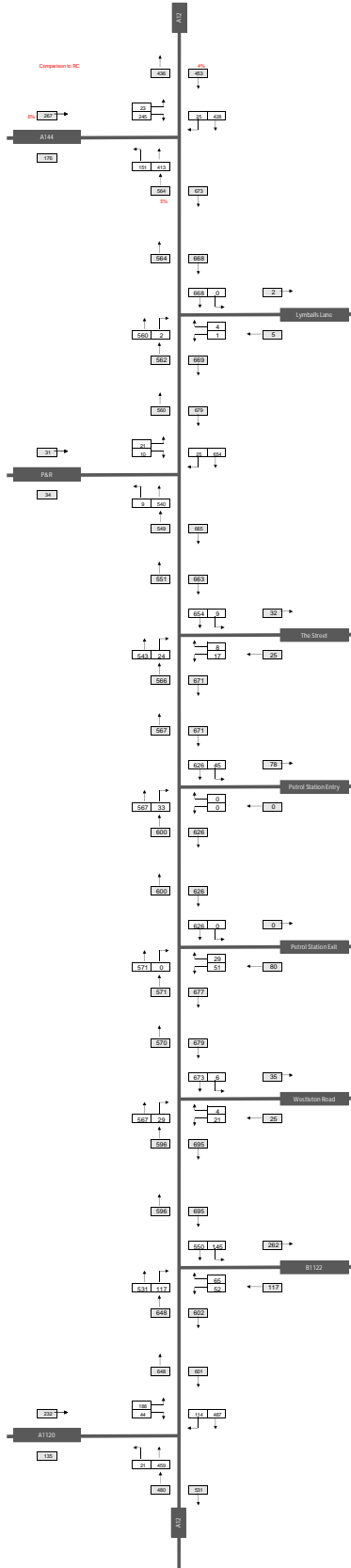

Title: 2028 PC AM	Client: EDF	Date: 24/09/2019
Time Period: 08:00 - 09:00	Project: Sizewell C	Reference: 50400326



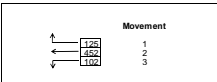
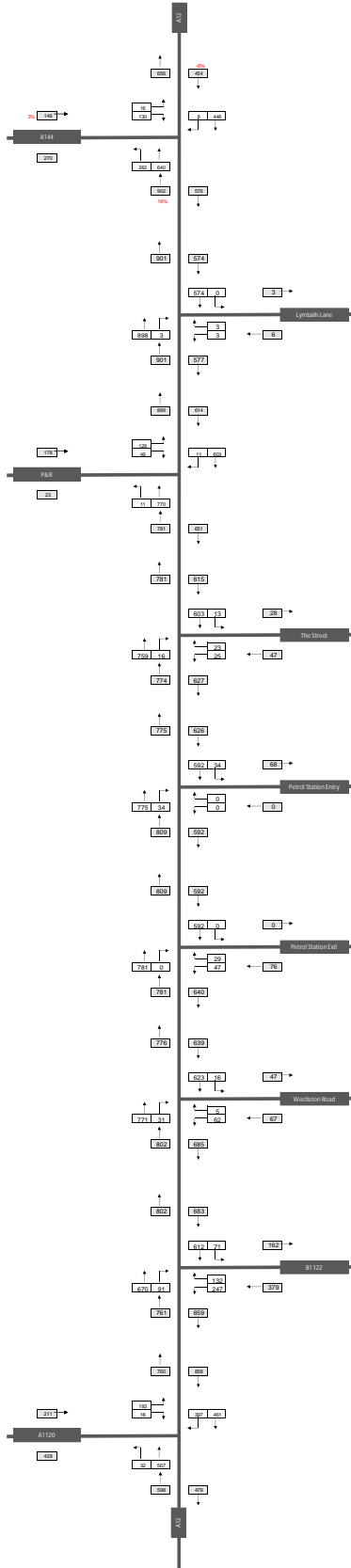

<p>Title: 2028 PC IP</p>	<p>Client: EDF</p>	<p>Date: 24/09/2019</p>
<p>Time Period: 15:00 - 16:00</p>	<p>Project: Sizewell C</p>	<p>Reference: 50400326</p>

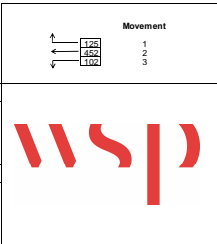

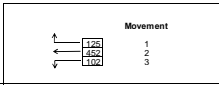
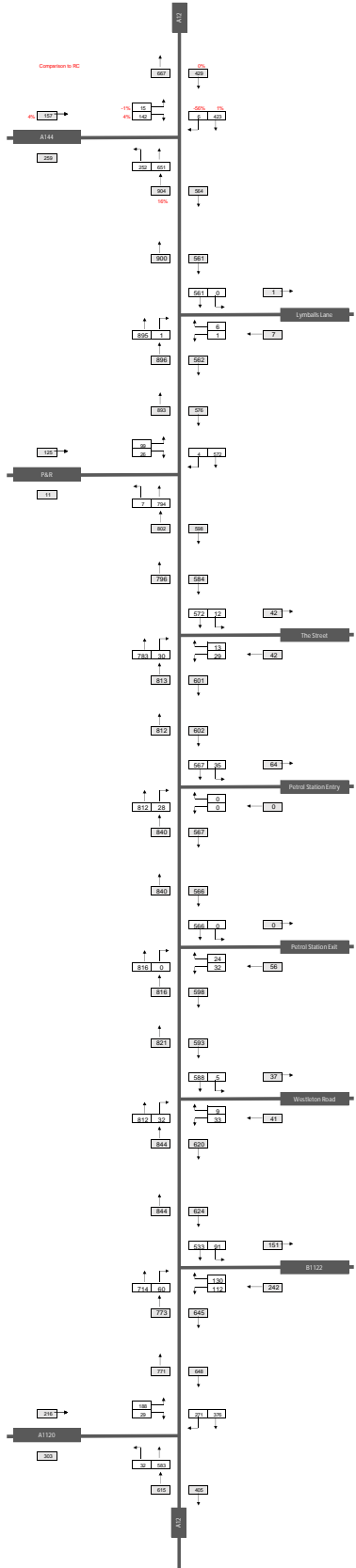

File:	Client:	Date:
2028 PC PM	EDF	24/09/2019
Time Period:	Project:	Reference:
17:00 - 18:00	Sizewell C	50400326



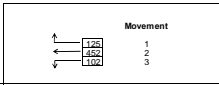
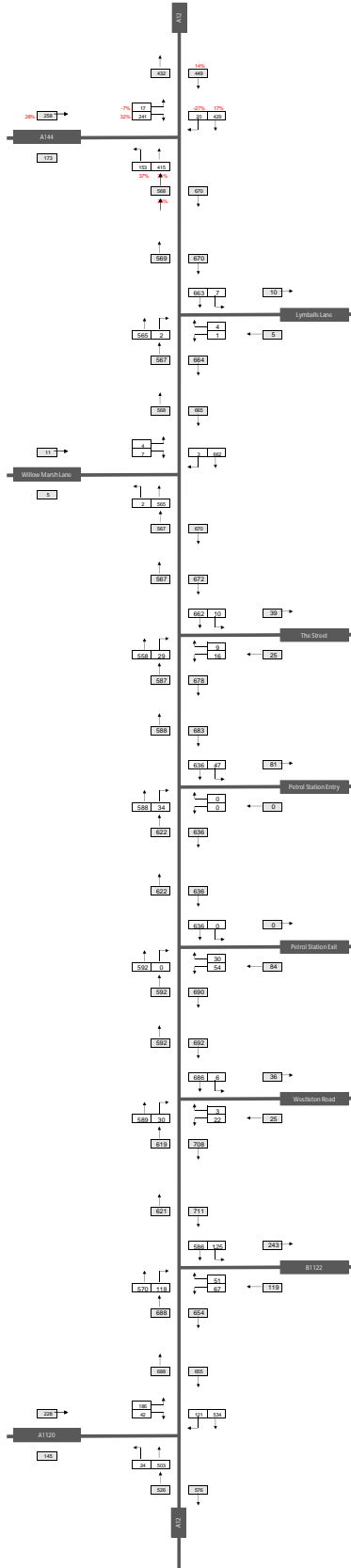

Title	Client	Date
2034 RC AM	EDF	24/09/2019
Time Period	Project	Reference
08:00 - 09:00	Sizewell C	50400326



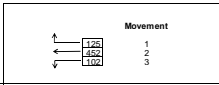

Title	Client	Date
2034 RC IP	EDF	24/09/2019
Title Period	Project	Reference
15:00 - 16:00	Sizewell C	50400326



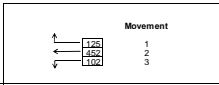

Title	Client	Date
2034 RC PM	EDF	24/09/2019
Time Period	Project	Reference
17:00 - 18:00	Sizewell C	50400326



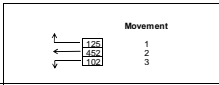

Title	Client	Date
2034 OP AM	EDF	24/09/2019
Time Period	Project	Reference
08:00 - 09:00	Sizewell C	50400326

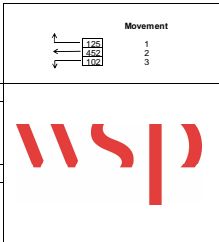

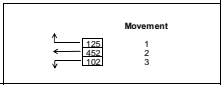
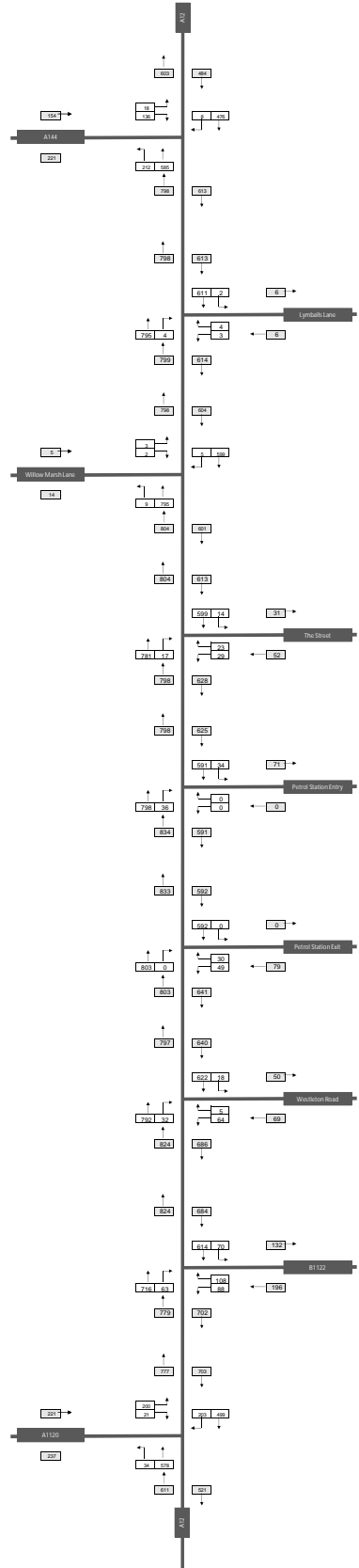

Title	Client	Date
2034 OP IP	EDF	24/09/2019
Title Period	Project	Reference
15:00 - 16:00	Sizewell C	50400326



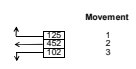
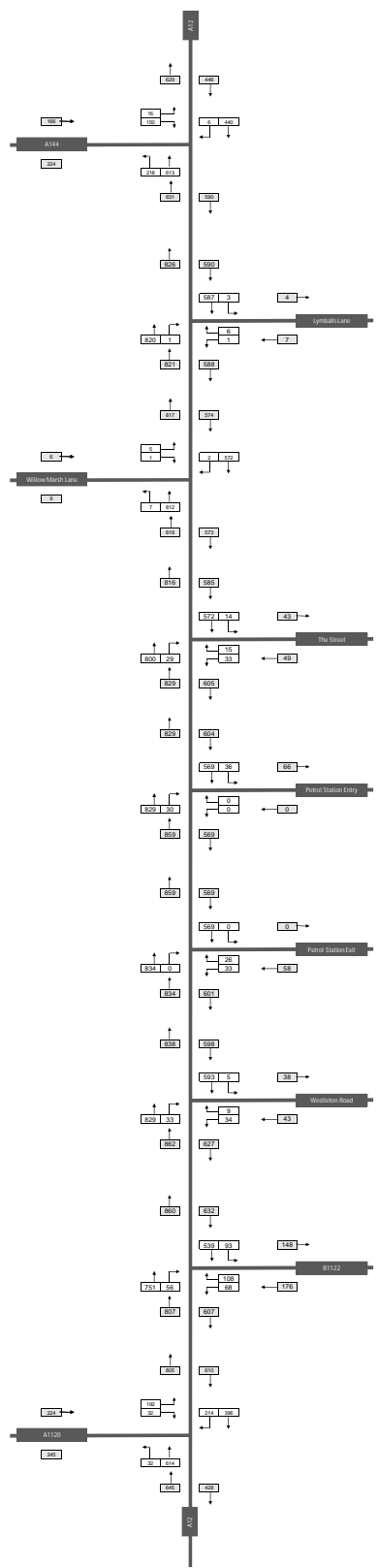
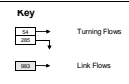

Title: 2034 OP PM	Client: EDF	Date: 24/09/2019
Time Period: 17:00 - 18:00	Project: Sizewell C	Reference: 50400326



Appendix B

BASE MODEL VALIDATION FIGURES





**Vehicle Flow Information
Calibration Statistics
All Vehicles
AM Peak**

Index	Junction	Name	Origin	Destination	Reference	Observed Flow	Modelled Flow	Difference	% Difference	G.E.H. Value (using hourly flows)	Flow Test (using hourly flows)
1	3	A1120 / A12	N	E	3:1:4	131	132	1	0.5%	0.1	Pass Low
2	3	A1120 / A12	N	W	3:1:5	34	33	-1	-2.9%	0.2	Pass Low
3	3	A1120 / A12	W	N	3:4:3	16	16	0	-0.6%	0.0	Pass Low
4	3	A1120 / A12	W	E	3:4:4	396	395	-1	-0.2%	0.0	Pass Low
5	3	A1120 / A12	E	N	3:5:3	83	85	2	1.8%	0.2	Pass Low
6	3	A1120 / A12	E	W	3:5:5	438	439	1	0.2%	0.0	Pass Low
7	4	A12 / B1122	W	E	4:8:9	445	445	0	0.0%	0.0	Pass Low
8	4	A12 / B1122	W	S	4:8:10	82	82	0	-0.2%	0.0	Pass Low
9	4	A12 / B1122	S	E	4:11:9	38	37	-1	-1.6%	0.1	Pass Low
10	4	A12 / B1122	S	W	4:11:12	53	50	-4	-6.6%	0.5	Pass Low
11	4	A12 / B1122	E	S	4:13:10	100	107	7	6.9%	0.7	Pass Low
12	4	A12 / B1122	E	W	4:13:12	468	476	8	1.7%	0.4	Pass Low
13	5	A12 / Westleton Rd	S	N	5:16:17	457	457	0	0.1%	0.0	Pass Low
14	5	A12 / Westleton Rd	S	E	5:16:19	26	25	-1	-2.7%	0.1	Pass Low
15	5	A12 / Westleton Rd	N	S	5:108:13	550	564	14	2.5%	0.6	Pass Low
16	5	A12 / Westleton Rd	N	E	5:108:19	4	5	1	35.0%	0.6	Pass Low
17	5	A12 / Westleton Rd	E	S	5:20:13	18	18	0	0.6%	0.0	Pass Low
18	5	A12 / Westleton Rd	E	N	5:20:17	3	3	0	6.7%	0.1	Pass Low
19	6	A12 / Petrol Station Exit	S	N	6:17:17	442	461	19	4.3%	0.9	Pass Low
20	6	A12 / Petrol Station Exit	N	S	6:56:55	510	522	12	2.3%	0.5	Pass Low
21	6	A12 / Petrol Station Exit	E	N	6:28:17	24	24	0	0.8%	0.0	Pass Low
22	6	A12 / Petrol Station Exit	E	S	6:28:55	44	44	0	0.2%	0.0	Pass Low
23	7	A12 / Petrol Station Entrance	S	N	7:17:17	433	458	25	5.7%	1.2	Pass Low
24	7	A12 / Petrol Station Entrance	S	E	7:17:47	27	27	0	1.5%	0.1	Pass Low
25	7	A12 / Petrol Station Entrance	N	S	7:55:55	510	522	12	2.3%	0.5	Pass Low
26	7	A12 / Petrol Station Entrance	N	E	7:55:47	37	38	1	3.2%	0.2	Pass Low
27	8	A12 / The St	S	N	8:33:33	445	445	0	0.0%	0.0	Pass Low
28	8	A12 / The St	S	E	8:33:35	12	12	0	-2.5%	0.1	Pass Low
29	8	A12 / The St	N	S	8:34:34	536	548	12	2.2%	0.5	Pass Low
30	8	A12 / The St	N	E	8:34:35	6	6	-1	-8.3%	0.2	Pass Low
31	8	A12 / The St	E	N	8:36:33	7	7	0	1.4%	0.0	Pass Low
32	8	A12 / The St	E	S	8:36:34	11	11	0	0.9%	0.0	Pass Low
33	9	A12 / Willow Marsh Ln	S	N	9:33:37	450	451	1	0.1%	0.0	Pass Low
34	9	A12 / Willow Marsh Ln	S	W	9:33:43	2	1	-1	-30.0%	0.5	Pass Low
35	9	A12 / Willow Marsh Ln	N	S	9:42:34	536	547	11	2.1%	0.5	Pass Low
36	9	A12 / Willow Marsh Ln	N	W	9:42:43	3	2	-1	-23.3%	0.4	Pass Low
37	9	A12 / Willow Marsh Ln	W	S	9:44:34	6	6	0	-3.3%	0.1	Pass Low
38	9	A12 / Willow Marsh Ln	W	N	9:44:37	3	3	0	3.3%	0.1	Pass Low
39	10	A12 / Lymballs Ln	S	N	10:37:37	451	450	-1	-0.3%	0.1	Pass Low
40	10	A12 / Lymballs Ln	S	E	10:37:45	2	2	0	-15.0%	0.2	Pass Low
41	10	A12 / Lymballs Ln	N	S	10:42:42	538	546	8	1.5%	0.3	Pass Low
42	10	A12 / Lymballs Ln	N	E	10:42:45	6	6	0	-6.7%	0.2	Pass Low
43	10	A12 / Lymballs Ln	E	N	10:46:37	3	4	1	23.3%	0.4	Pass Low
44	10	A12 / Lymballs Ln	E	S	10:46:42	1	1	0	-20.0%	0.2	Pass Low
45	11	A12 / A144	S	N	11:37:38	341	344	3	0.8%	0.2	Pass Low
46	11	A12 / A144	S	W	11:37:40	113	111	-2	-1.4%	0.2	Pass Low
47	11	A12 / A144	W	N	11:41:38	19	18	-1	-3.2%	0.1	Pass Low
48	11	A12 / A144	W	S	11:41:42	178	182	4	2.2%	0.3	Pass Low
49	11	A12 / A144	N	W	11:49:40	27	27	0	1.1%	0.1	Pass Low
50	11	A12 / A144	N	S	11:49:42	366	368	2	0.6%	0.1	Pass Low

	Sum Obs.	Sum Mod.	Diff	% Diff	Ave. GEH
Overall Stats	9431	9562	131	1.4%	0.2



**Vehicle Flow Information
Calibration Statistics
Car Vehicles
AM Peak**

Index	Junction	Name	Origin	Destination	Reference	Observed Flow	Modelled Flow	Difference	% Difference	G.E.H. Value (using hourly flows)	Flow Test (using hourly flows)
1	3	A1120 / A12	N	E	3:1:4	97	97	0	-0.2%	0.0	Pass Low
2	3	A1120 / A12	N	W	3:1:5	27	27	0	-1.1%	0.1	Pass Low
3	3	A1120 / A12	W	N	3:4:3	13	13	0	-3.1%	0.1	Pass Low
4	3	A1120 / A12	W	E	3:4:4	273	273	0	-0.1%	0.0	Pass Low
5	3	A1120 / A12	E	N	3:5:3	68	70	2	2.2%	0.2	Pass Low
6	3	A1120 / A12	E	W	3:5:5	333	334	1	0.2%	0.0	Pass Low
7	4	A12 / B1122	W	E	4:8:9	307	307	0	0.0%	0.0	Pass Low
8	4	A12 / B1122	W	S	4:8:10	63	63	0	-0.6%	0.1	Pass Low
9	4	A12 / B1122	S	E	4:11:9	24	24	0	-0.8%	0.0	Pass Low
10	4	A12 / B1122	S	W	4:11:12	46	43	-3	-6.1%	0.4	Pass Low
11	4	A12 / B1122	E	S	4:13:10	75	80	5	7.1%	0.6	Pass Low
12	4	A12 / B1122	E	W	4:13:12	355	362	7	1.8%	0.3	Pass Low
13	5	A12 / Westleton Rd	S	N	5:16:17	312	312	0	0.1%	0.0	Pass Low
14	5	A12 / Westleton Rd	S	E	5:16:19	19	19	0	-1.6%	0.1	Pass Low
15	5	A12 / Westleton Rd	N	S	5:108:13	413	423	10	2.5%	0.5	Pass Low
16	5	A12 / Westleton Rd	N	E	5:108:19	3	4	1	26.7%	0.4	Pass Low
17	5	A12 / Westleton Rd	E	S	5:20:13	17	18	0	2.9%	0.1	Pass Low
18	5	A12 / Westleton Rd	E	N	5:20:17	2	2	0	10.0%	0.1	Pass Low
19	6	A12 / Petrol Station Exit	S	N	6:17:17	314	314	0	0.1%	0.0	Pass Low
20	6	A12 / Petrol Station Exit	N	S	6:56:55	390	399	9	2.4%	0.5	Pass Low
21	6	A12 / Petrol Station Exit	E	N	6:28:17	18	18	0	0.0%	0.0	Pass Low
22	6	A12 / Petrol Station Exit	E	S	6:28:55	26	26	0	-0.8%	0.0	Pass Low
23	7	A12 / Petrol Station Entrance	S	N	7:17:17	296	314	18	6.1%	1.0	Pass Low
24	7	A12 / Petrol Station Entrance	S	E	7:17:47	18	18	0	1.7%	0.1	Pass Low
25	7	A12 / Petrol Station Entrance	N	S	7:55:55	390	399	9	2.4%	0.5	Pass Low
26	7	A12 / Petrol Station Entrance	N	E	7:55:47	23	24	1	3.5%	0.2	Pass Low
27	8	A12 / The St	S	N	8:33:33	305	305	0	0.0%	0.0	Pass Low
28	8	A12 / The St	S	E	8:33:35	9	9	0	-3.3%	0.1	Pass Low
29	8	A12 / The St	N	S	8:34:34	403	413	10	2.4%	0.5	Pass Low
30	8	A12 / The St	N	E	8:34:35	4	4	0	-5.0%	0.1	Pass Low
31	8	A12 / The St	E	N	8:36:33	3	3	0	-3.3%	0.1	Pass Low
32	8	A12 / The St	E	S	8:36:34	10	10	0	1.0%	0.0	Pass Low
33	9	A12 / Willow Marsh Ln	S	N	9:33:37	307	307	0	0.1%	0.0	Pass Low
34	9	A12 / Willow Marsh Ln	S	W	9:33:43	1	1	0	-10.0%	0.1	Pass Low
35	9	A12 / Willow Marsh Ln	N	S	9:42:34	404	413	9	2.1%	0.4	Pass Low
36	9	A12 / Willow Marsh Ln	N	W	9:42:43	3	2	-1	-23.3%	0.4	Pass Low
37	9	A12 / Willow Marsh Ln	W	S	9:44:34	3	3	0	10.0%	0.2	Pass Low
38	9	A12 / Willow Marsh Ln	W	N	9:44:37	1	1	0	20.0%	0.2	Pass Low
39	10	A12 / Lymballs Ln	S	N	10:37:37	306	305	-1	-0.3%	0.0	Pass Low
40	10	A12 / Lymballs Ln	S	E	10:37:45	2	2	0	-15.0%	0.2	Pass Low
41	10	A12 / Lymballs Ln	N	S	10:42:42	406	412	6	1.4%	0.3	Pass Low
42	10	A12 / Lymballs Ln	N	E	10:42:45	5	5	-1	-10.0%	0.2	Pass Low
43	10	A12 / Lymballs Ln	E	N	10:46:37	2	2	0	10.0%	0.1	Pass Low
44	10	A12 / Lymballs Ln	E	S	10:46:42	1	1	0	-20.0%	0.2	Pass Low
45	11	A12 / A144	S	N	11:37:38	225	227	2	0.9%	0.1	Pass Low
46	11	A12 / A144	S	W	11:37:40	83	81	-2	-2.3%	0.2	Pass Low
47	11	A12 / A144	W	N	11:41:38	14	13	-1	-5.0%	0.2	Pass Low
48	11	A12 / A144	W	S	11:41:42	132	136	4	2.7%	0.3	Pass Low
49	11	A12 / A144	N	W	11:49:40	20	20	0	0.5%	0.0	Pass Low
50	11	A12 / A144	N	S	11:49:42	279	280	1	0.2%	0.0	Pass Low

	Sum Obs.	Sum Mod.	Diff	% Diff	Ave. GEH
Overall Stats	6850	6935	85	1.2%	0.2



**Vehicle Flow Information
Calibration Statistics
HGV Vehicles
AM Peak**

Index	Junction	Name	Origin	Destination	Reference	Observed Flow	Modelled Flow	Difference	% Difference	G.E.H. Value (using hourly flows)	Flow Test (using hourly flows)
1	3	A1120 / A12	N	E	3:1:4	2	2	0	20.0%	0.3	Pass Low
2	3	A1120 / A12	N	W	3:1:5	1	0	-1	-70.0%	0.9	Pass Low
3	3	A1120 / A12	W	N	3:4:3	1	1	0	-10.0%	0.1	Pass Low
4	3	A1120 / A12	W	E	3:4:4	48	48	0	0.2%	0.0	Pass Low
5	3	A1120 / A12	E	N	3:5:3	4	4	0	-7.5%	0.2	Pass Low
6	3	A1120 / A12	E	W	3:5:5	25	26	1	3.6%	0.2	Pass Low
7	4	A12 / B1122	W	E	4:8:9	49	50	0	1.0%	0.1	Pass Low
8	4	A12 / B1122	W	S	4:8:10	1	1	0	0.0%	0.0	Pass Low
9	4	A12 / B1122	S	E	4:11:9	2	2	0	0.0%	0.0	Pass Low
10	4	A12 / B1122	S	W	4:11:12	1	0	-1	-90.0%	1.2	Pass Low
11	4	A12 / B1122	E	S	4:13:10	3	3	0	6.7%	0.1	Pass Low
12	4	A12 / B1122	E	W	4:13:12	28	29	1	5.0%	0.3	Pass Low
13	5	A12 / Westleton Rd	S	N	5:16:17	48	49	1	2.1%	0.1	Pass Low
14	5	A12 / Westleton Rd	S	E	5:16:19	3	3	0	-3.3%	0.1	Pass Low
15	5	A12 / Westleton Rd	N	S	5:108:13	31	33	2	4.8%	0.3	Pass Low
16	5	A12 / Westleton Rd	N	E	5:108:19	0	0	0		0.0	Pass Low
17	5	A12 / Westleton Rd	E	S	5:20:13	0	0	0		0.0	Pass Low
18	5	A12 / Westleton Rd	E	N	5:20:17	0	0	0		0.0	Pass Low
19	6	A12 / Petrol Station Exit	S	N	6:17:17	36	49	13	36.4%	2.0	Pass Low
20	6	A12 / Petrol Station Exit	N	S	6:56:55	30	31	1	3.0%	0.2	Pass Low
21	6	A12 / Petrol Station Exit	E	N	6:28:17	0	0	0		0.0	Pass Low
22	6	A12 / Petrol Station Exit	E	S	6:28:55	1	1	0	-10.0%	0.1	Pass Low
23	7	A12 / Petrol Station Entrance	S	N	7:17:17	48	49	1	2.3%	0.2	Pass Low
24	7	A12 / Petrol Station Entrance	S	E	7:17:47	0	0	0		0.0	Pass Low
25	7	A12 / Petrol Station Entrance	N	S	7:55:55	30	31	1	2.3%	0.1	Pass Low
26	7	A12 / Petrol Station Entrance	N	E	7:55:47	1	1	0	30.0%	0.3	Pass Low
27	8	A12 / The St	S	N	8:33:33	48	49	1	1.5%	0.1	Pass Low
28	8	A12 / The St	S	E	8:33:35	0	0	0		0.4	Pass Low
29	8	A12 / The St	N	S	8:34:34	31	32	1	2.6%	0.1	Pass Low
30	8	A12 / The St	N	E	8:34:35	2	2	0	-20.0%	0.3	Pass Low
31	8	A12 / The St	E	N	8:36:33	3	3	0	-3.3%	0.1	Pass Low
32	8	A12 / The St	E	S	8:36:34	0	0	0		0.0	Pass Low
33	9	A12 / Willow Marsh Ln	S	N	9:33:37	51	51	0	0.6%	0.0	Pass Low
34	9	A12 / Willow Marsh Ln	S	W	9:33:43	0	0	0		0.0	Pass Low
35	9	A12 / Willow Marsh Ln	N	S	9:42:34	31	32	1	1.9%	0.1	Pass Low
36	9	A12 / Willow Marsh Ln	N	W	9:42:43	0	0	0		0.0	Pass Low
37	9	A12 / Willow Marsh Ln	W	S	9:44:34	2	2	0	-15.0%	0.2	Pass Low
38	9	A12 / Willow Marsh Ln	W	N	9:44:37	0	0	0		0.0	Pass Low
39	10	A12 / Lymballs Ln	S	N	10:37:37	51	51	0	0.0%	0.0	Pass Low
40	10	A12 / Lymballs Ln	S	E	10:37:45	0	0	0		0.0	Pass Low
41	10	A12 / Lymballs Ln	N	S	10:42:42	31	31	0	1.3%	0.1	Pass Low
42	10	A12 / Lymballs Ln	N	E	10:42:45	0	0	0		0.0	Pass Low
43	10	A12 / Lymballs Ln	E	N	10:46:37	0	0	0		0.0	Pass Low
44	10	A12 / Lymballs Ln	E	S	10:46:42	0	0	0		0.0	Pass Low
45	11	A12 / A144	S	N	11:37:38	44	44	0	-0.9%	0.1	Pass Low
46	11	A12 / A144	S	W	11:37:40	7	8	1	10.0%	0.3	Pass Low
47	11	A12 / A144	W	N	11:41:38	4	4	0	2.5%	0.0	Pass Low
48	11	A12 / A144	W	S	11:41:42	8	8	0	-1.3%	0.0	Pass Low
49	11	A12 / A144	N	W	11:49:40	3	3	0	0.0%	0.0	Pass Low
50	11	A12 / A144	N	S	11:49:42	23	23	0	1.3%	0.1	Pass Low

	Sum Obs.	Sum Mod.	Diff	% Diff	Ave. GEH
Overall Stats	732	755	23	3.1%	0.2



**Vehicle Flow Information
Calibration Statistics
LGV Vehicles
AM Peak**

Index	Junction	Name	Origin	Destination	Reference	Observed Flow	Modelled Flow	Difference	% Difference	G.E.H. Value (using hourly flows)	Flow Test (using hourly flows)
1	3	A1120 / A12	N	E	3:1:4	32	33	1	1.6%	0.1	Pass Low
2	3	A1120 / A12	N	W	3:1:5	6	6	0	0.0%	0.0	Pass Low
3	3	A1120 / A12	W	N	3:4:3	2	2	0	20.0%	0.3	Pass Low
4	3	A1120 / A12	W	E	3:4:4	75	74	-1	-0.9%	0.1	Pass Low
5	3	A1120 / A12	E	N	3:5:3	11	11	0	2.7%	0.1	Pass Low
6	3	A1120 / A12	E	W	3:5:5	80	79	-1	-0.9%	0.1	Pass Low
7	4	A12 / B1122	W	E	4:8:9	89	89	0	-0.3%	0.0	Pass Low
8	4	A12 / B1122	W	S	4:8:10	18	18	0	1.1%	0.0	Pass Low
9	4	A12 / B1122	S	E	4:11:9	12	12	0	-3.3%	0.1	Pass Low
10	4	A12 / B1122	S	W	4:11:12	6	6	0	3.3%	0.1	Pass Low
11	4	A12 / B1122	E	S	4:13:10	22	23	1	6.4%	0.3	Pass Low
12	4	A12 / B1122	E	W	4:13:12	85	85	0	-0.1%	0.0	Pass Low
13	5	A12 / Westleton Rd	S	N	5:16:17	97	96	-1	-0.8%	0.1	Pass Low
14	5	A12 / Westleton Rd	S	E	5:16:19	4	4	0	-7.5%	0.2	Pass Low
15	5	A12 / Westleton Rd	N	S	5:108:13	106	108	2	1.6%	0.2	Pass Low
16	5	A12 / Westleton Rd	N	E	5:108:19	1	2	1	60.0%	0.5	Pass Low
17	5	A12 / Westleton Rd	E	S	5:20:13	1	1	0	-40.0%	0.4	Pass Low
18	5	A12 / Westleton Rd	E	N	5:20:17	1	1	0	0.0%	0.0	Pass Low
19	6	A12 / Petrol Station Exit	S	N	6:17:17	92	98	6	6.0%	0.6	Pass Low
20	6	A12 / Petrol Station Exit	N	S	6:56:55	90	92	2	1.8%	0.2	Pass Low
21	6	A12 / Petrol Station Exit	E	N	6:28:17	6	6	0	3.3%	0.1	Pass Low
22	6	A12 / Petrol Station Exit	E	S	6:28:55	17	17	0	2.4%	0.1	Pass Low
23	7	A12 / Petrol Station Entrance	S	N	7:17:17	89	94	5	6.1%	0.6	Pass Low
24	7	A12 / Petrol Station Entrance	S	E	7:17:47	9	9	0	1.1%	0.0	Pass Low
25	7	A12 / Petrol Station Entrance	N	S	7:55:55	90	92	2	1.9%	0.2	Pass Low
26	7	A12 / Petrol Station Entrance	N	E	7:55:47	13	13	0	0.8%	0.0	Pass Low
27	8	A12 / The St	S	N	8:33:33	92	91	-1	-1.0%	0.1	Pass Low
28	8	A12 / The St	S	E	8:33:35	3	3	0	-3.3%	0.1	Pass Low
29	8	A12 / The St	N	S	8:34:34	102	104	1	1.5%	0.1	Pass Low
30	8	A12 / The St	N	E	8:34:35	0	0	0		0.4	Pass Low
31	8	A12 / The St	E	N	8:36:33	1	1	0	30.0%	0.3	Pass Low
32	8	A12 / The St	E	S	8:36:34	1	1	0	0.0%	0.0	Pass Low
33	9	A12 / Willow Marsh Ln	S	N	9:33:37	92	92	0	-0.1%	0.0	Pass Low
34	9	A12 / Willow Marsh Ln	S	W	9:33:43	1	1	-1	-50.0%	0.6	Pass Low
35	9	A12 / Willow Marsh Ln	N	S	9:42:34	101	103	2	2.2%	0.2	Pass Low
36	9	A12 / Willow Marsh Ln	N	W	9:42:43	0	0	0		0.0	Pass Low
37	9	A12 / Willow Marsh Ln	W	S	9:44:34	1	1	0	-20.0%	0.2	Pass Low
38	9	A12 / Willow Marsh Ln	W	N	9:44:37	2	2	0	-5.0%	0.1	Pass Low
39	10	A12 / Lymballs Ln	S	N	10:37:37	94	94	0	-0.4%	0.0	Pass Low
40	10	A12 / Lymballs Ln	S	E	10:37:45	0	0	0		0.0	Pass Low
41	10	A12 / Lymballs Ln	N	S	10:42:42	101	103	2	1.8%	0.2	Pass Low
42	10	A12 / Lymballs Ln	N	E	10:42:45	1	1	0	10.0%	0.1	Pass Low
43	10	A12 / Lymballs Ln	E	N	10:46:37	1	2	1	50.0%	0.4	Pass Low
44	10	A12 / Lymballs Ln	E	S	10:46:42	0	0	0		0.0	Pass Low
45	11	A12 / A144	S	N	11:37:38	72	73	1	1.5%	0.1	Pass Low
46	11	A12 / A144	S	W	11:37:40	23	23	0	-1.7%	0.1	Pass Low
47	11	A12 / A144	W	N	11:41:38	1	1	0	0.0%	0.0	Pass Low
48	11	A12 / A144	W	S	11:41:42	38	38	0	1.1%	0.1	Pass Low
49	11	A12 / A144	N	W	11:49:40	4	4	0	5.0%	0.1	Pass Low
50	11	A12 / A144	N	S	11:49:42	64	65	1	1.9%	0.1	Pass Low

	Sum Obs.	Sum Mod.	Diff	% Diff	Ave. GEH
Overall Stats	1849	1872	23	1.3%	0.2



**Vehicle Flow Information
Calibration Statistics
All Vehicles
IP Peak**

Index	Junction	Name	Origin	Destination	Reference	Observed Flow	Modelled Flow	Difference	% Difference	G.E.H. Value (using hourly flows)	Flow Test (using hourly flows)
1	3	A1120 / A12	N	E	3:1:4	132	131	-1	-0.8%	0.1	Pass Low
2	3	A1120 / A12	N	W	3:1:5	9	9	0	-1.1%	0.0	Pass Low
3	3	A1120 / A12	W	N	3:4:3	22	22	0	-1.8%	0.1	Pass Low
4	3	A1120 / A12	W	E	3:4:4	508	505	-3	-0.6%	0.1	Pass Low
5	3	A1120 / A12	E	N	3:5:3	155	154	-1	-0.9%	0.1	Pass Low
6	3	A1120 / A12	E	W	3:5:5	430	430	0	-0.1%	0.0	Pass Low
7	4	A12 / B1122	W	E	4:8:9	579	576	-3	-0.6%	0.1	Pass Low
8	4	A12 / B1122	W	S	4:8:10	61	61	0	0.0%	0.0	Pass Low
9	4	A12 / B1122	S	E	4:11:9	83	83	0	-0.5%	0.0	Pass Low
10	4	A12 / B1122	S	W	4:11:12	87	88	1	0.6%	0.1	Pass Low
11	4	A12 / B1122	E	S	4:13:10	47	47	0	0.0%	0.0	Pass Low
12	4	A12 / B1122	E	W	4:13:12	498	497	-1	-0.2%	0.0	Pass Low
13	5	A12 / Westleton Rd	S	N	5:16:17	634	633	-1	-0.1%	0.0	Pass Low
14	5	A12 / Westleton Rd	S	E	5:16:19	28	26	-2	-5.7%	0.3	Pass Low
15	5	A12 / Westleton Rd	N	S	5:108:13	492	492	0	-0.1%	0.0	Pass Low
16	5	A12 / Westleton Rd	N	E	5:108:19	15	14	-1	-4.0%	0.2	Pass Low
17	5	A12 / Westleton Rd	E	S	5:20:13	53	54	0	0.9%	0.1	Pass Low
18	5	A12 / Westleton Rd	E	N	5:20:17	5	5	0	-6.0%	0.1	Pass Low
19	6	A12 / Petrol Station Exit	S	N	6:17:17	639	639	0	0.1%	0.0	Pass Low
20	6	A12 / Petrol Station Exit	N	S	6:56:55	467	467	0	0.0%	0.0	Pass Low
21	6	A12 / Petrol Station Exit	E	N	6:28:17	24	25	1	2.1%	0.1	Pass Low
22	6	A12 / Petrol Station Exit	E	S	6:28:55	40	40	0	0.3%	0.0	Pass Low
23	7	A12 / Petrol Station Entrance	S	N	7:17:17	609	635	26	4.3%	1.0	Pass Low
24	7	A12 / Petrol Station Entrance	S	E	7:17:47	30	31	1	3.0%	0.2	Pass Low
25	7	A12 / Petrol Station Entrance	N	S	7:55:55	467	467	0	0.0%	0.0	Pass Low
26	7	A12 / Petrol Station Entrance	N	E	7:55:47	29	29	0	-0.7%	0.0	Pass Low
27	8	A12 / The St	S	N	8:33:33	626	629	3	0.5%	0.1	Pass Low
28	8	A12 / The St	S	E	8:33:35	7	6	-1	-12.9%	0.4	Pass Low
29	8	A12 / The St	N	S	8:34:34	483	484	1	0.1%	0.0	Pass Low
30	8	A12 / The St	N	E	8:34:35	11	10	-1	-6.4%	0.2	Pass Low
31	8	A12 / The St	E	N	8:36:33	19	19	0	-0.5%	0.0	Pass Low
32	8	A12 / The St	E	S	8:36:34	13	14	1	5.4%	0.2	Pass Low
33	9	A12 / Willow Marsh Ln	S	N	9:33:37	637	640	3	0.5%	0.1	Pass Low
34	9	A12 / Willow Marsh Ln	S	W	9:33:43	8	8	0	2.5%	0.1	Pass Low
35	9	A12 / Willow Marsh Ln	N	S	9:42:34	492	491	-1	-0.2%	0.0	Pass Low
36	9	A12 / Willow Marsh Ln	N	W	9:42:43	4	4	0	5.0%	0.1	Pass Low
37	9	A12 / Willow Marsh Ln	W	S	9:44:34	2	2	0	-20.0%	0.3	Pass Low
38	9	A12 / Willow Marsh Ln	W	N	9:44:37	2	3	1	30.0%	0.4	Pass Low
39	10	A12 / Lymballs Ln	S	N	10:37:37	636	640	4	0.6%	0.1	Pass Low
40	10	A12 / Lymballs Ln	S	E	10:37:45	3	3	0	-3.3%	0.1	Pass Low
41	10	A12 / Lymballs Ln	N	S	10:42:42	493	494	1	0.2%	0.0	Pass Low
42	10	A12 / Lymballs Ln	N	E	10:42:45	2	2	0	10.0%	0.1	Pass Low
43	10	A12 / Lymballs Ln	E	N	10:46:37	3	3	0	-3.3%	0.1	Pass Low
44	10	A12 / Lymballs Ln	E	S	10:46:42	3	2	-1	-23.3%	0.4	Pass Low
45	11	A12 / A144	S	N	11:37:38	482	486	4	0.8%	0.2	Pass Low
46	11	A12 / A144	S	W	11:37:40	157	157	0	0.3%	0.0	Pass Low
47	11	A12 / A144	W	N	11:41:38	17	18	1	3.5%	0.1	Pass Low
48	11	A12 / A144	W	S	11:41:42	100	98	-3	-2.5%	0.3	Pass Low
49	11	A12 / A144	N	W	11:49:40	26	26	0	-0.8%	0.0	Pass Low
50	11	A12 / A144	N	S	11:49:42	395	398	3	0.7%	0.1	Pass Low

	Sum Obs.	Sum Mod.	Diff	% Diff	Ave. GEH
Overall Stats	10764	10792	28	0.3%	0.1



**Vehicle Flow Information
Calibration Statistics
Car Vehicles
IP Peak**

Index	Junction	Name	Origin	Destination	Reference	Observed Flow	Modelled Flow	Difference	% Difference	G.E.H. Value (using hourly flows)	Flow Test (using hourly flows)
1	3	A1120 / A12	N	E	3:1:4	114	113	-1	-1.3%	0.1	Pass Low
2	3	A1120 / A12	N	W	3:1:5	7	7	0	-1.4%	0.0	Pass Low
3	3	A1120 / A12	W	N	3:4:3	20	20	0	-1.0%	0.0	Pass Low
4	3	A1120 / A12	W	E	3:4:4	417	416	-2	-0.4%	0.1	Pass Low
5	3	A1120 / A12	E	N	3:5:3	126	124	-2	-1.9%	0.2	Pass Low
6	3	A1120 / A12	E	W	3:5:5	342	342	0	0.1%	0.0	Pass Low
7	4	A12 / B1122	W	E	4:8:9	482	480	-2	-0.5%	0.1	Pass Low
8	4	A12 / B1122	W	S	4:8:10	49	49	0	-0.2%	0.0	Pass Low
9	4	A12 / B1122	S	E	4:11:9	70	70	0	0.3%	0.0	Pass Low
10	4	A12 / B1122	S	W	4:11:12	66	66	0	-0.5%	0.0	Pass Low
11	4	A12 / B1122	E	S	4:13:10	36	36	0	-0.3%	0.0	Pass Low
12	4	A12 / B1122	E	W	4:13:12	402	401	-1	-0.3%	0.1	Pass Low
13	5	A12 / Westleton Rd	S	N	5:16:17	526	526	0	-0.1%	0.0	Pass Low
14	5	A12 / Westleton Rd	S	E	5:16:19	26	25	-1	-4.2%	0.2	Pass Low
15	5	A12 / Westleton Rd	N	S	5:108:13	387	387	0	-0.1%	0.0	Pass Low
16	5	A12 / Westleton Rd	N	E	5:108:19	14	14	0	-2.9%	0.1	Pass Low
17	5	A12 / Westleton Rd	E	S	5:20:13	51	51	-1	-1.0%	0.1	Pass Low
18	5	A12 / Westleton Rd	E	N	5:20:17	5	5	0	-6.0%	0.1	Pass Low
19	6	A12 / Petrol Station Exit	S	N	6:17:17	531	532	0	0.1%	0.0	Pass Low
20	6	A12 / Petrol Station Exit	N	S	6:56:55	367	366	-1	-0.2%	0.0	Pass Low
21	6	A12 / Petrol Station Exit	E	N	6:28:17	21	21	0	1.4%	0.1	Pass Low
22	6	A12 / Petrol Station Exit	E	S	6:28:55	34	34	0	0.3%	0.0	Pass Low
23	7	A12 / Petrol Station Entrance	S	N	7:17:17	506	529	23	4.5%	1.0	Pass Low
24	7	A12 / Petrol Station Entrance	S	E	7:17:47	25	26	1	2.0%	0.1	Pass Low
25	7	A12 / Petrol Station Entrance	N	S	7:55:55	367	366	-1	-0.2%	0.0	Pass Low
26	7	A12 / Petrol Station Entrance	N	E	7:55:47	23	23	0	0.9%	0.0	Pass Low
27	8	A12 / The St	S	N	8:33:33	520	523	2	0.5%	0.1	Pass Low
28	8	A12 / The St	S	E	8:33:35	7	6	-1	-12.9%	0.4	Pass Low
29	8	A12 / The St	N	S	8:34:34	379	379	0	0.1%	0.0	Pass Low
30	8	A12 / The St	N	E	8:34:35	10	9	-1	-6.0%	0.2	Pass Low
31	8	A12 / The St	E	N	8:36:33	14	13	-1	-4.3%	0.2	Pass Low
32	8	A12 / The St	E	S	8:36:34	11	11	0	1.8%	0.1	Pass Low
33	9	A12 / Willow Marsh Ln	S	N	9:33:37	529	531	2	0.4%	0.1	Pass Low
34	9	A12 / Willow Marsh Ln	S	W	9:33:43	5	5	0	-2.0%	0.0	Pass Low
35	9	A12 / Willow Marsh Ln	N	S	9:42:34	388	387	-1	-0.2%	0.0	Pass Low
36	9	A12 / Willow Marsh Ln	N	W	9:42:43	4	4	0	5.0%	0.1	Pass Low
37	9	A12 / Willow Marsh Ln	W	S	9:44:34	1	1	0	-30.0%	0.3	Pass Low
38	9	A12 / Willow Marsh Ln	W	N	9:44:37	1	2	1	50.0%	0.4	Pass Low
39	10	A12 / Lymballs Ln	S	N	10:37:37	530	532	2	0.4%	0.1	Pass Low
40	10	A12 / Lymballs Ln	S	E	10:37:45	0	0	0		0.0	Pass Low
41	10	A12 / Lymballs Ln	N	S	10:42:42	390	391	1	0.2%	0.0	Pass Low
42	10	A12 / Lymballs Ln	N	E	10:42:45	2	2	0	10.0%	0.1	Pass Low
43	10	A12 / Lymballs Ln	E	N	10:46:37	3	3	0	-3.3%	0.1	Pass Low
44	10	A12 / Lymballs Ln	E	S	10:46:42	2	1	-1	-30.0%	0.5	Pass Low
45	11	A12 / A144	S	N	11:37:38	400	402	2	0.6%	0.1	Pass Low
46	11	A12 / A144	S	W	11:37:40	133	134	1	0.9%	0.1	Pass Low
47	11	A12 / A144	W	N	11:41:38	14	14	0	2.9%	0.1	Pass Low
48	11	A12 / A144	W	S	11:41:42	75	73	-3	-3.3%	0.3	Pass Low
49	11	A12 / A144	N	W	11:49:40	23	23	0	-0.9%	0.0	Pass Low
50	11	A12 / A144	N	S	11:49:42	317	320	3	1.0%	0.2	Pass Low

	Sum Obs.	Sum Mod.	Diff	% Diff	Ave. GEH
Overall Stats	8772	8792	20	0.2%	0.1



**Vehicle Flow Information
Calibration Statistics
HGV Vehicles
IP Peak**

Index	Junction	Name	Origin	Destination	Reference	Observed Flow	Modelled Flow	Difference	% Difference	G.E.H. Value (using hourly flows)	Flow Test (using hourly flows)
1	3	A1120 / A12	N	E	3:1:4	5	6	1	14.0%	0.3	Pass Low
2	3	A1120 / A12	N	W	3:1:5	0	0	0		0.0	Pass Low
3	3	A1120 / A12	W	N	3:4:3	0	0	0		0.0	Pass Low
4	3	A1120 / A12	W	E	3:4:4	19	19	-1	-2.6%	0.1	Pass Low
5	3	A1120 / A12	E	N	3:5:3	8	8	0	5.0%	0.1	Pass Low
6	3	A1120 / A12	E	W	3:5:5	26	25	-1	-5.0%	0.3	Pass Low
7	4	A12 / B1122	W	E	4:8:9	22	22	0	0.9%	0.0	Pass Low
8	4	A12 / B1122	W	S	4:8:10	2	2	0	-5.0%	0.1	Pass Low
9	4	A12 / B1122	S	E	4:11:9	5	4	-1	-18.0%	0.4	Pass Low
10	4	A12 / B1122	S	W	4:11:12	5	5	0	0.0%	0.0	Pass Low
11	4	A12 / B1122	E	S	4:13:10	0	0	0		0.0	Pass Low
12	4	A12 / B1122	E	W	4:13:12	29	28	-1	-2.1%	0.1	Pass Low
13	5	A12 / Westleton Rd	S	N	5:16:17	27	26	-1	-3.0%	0.2	Pass Low
14	5	A12 / Westleton Rd	S	E	5:16:19	0	0	0		0.0	Pass Low
15	5	A12 / Westleton Rd	N	S	5:108:13	28	28	0	-1.4%	0.1	Pass Low
16	5	A12 / Westleton Rd	N	E	5:108:19	0	0	0		0.0	Pass Low
17	5	A12 / Westleton Rd	E	S	5:20:13	1	1	0	0.0%	0.0	Pass Low
18	5	A12 / Westleton Rd	E	N	5:20:17	0	0	0		0.0	Pass Low
19	6	A12 / Petrol Station Exit	S	N	6:17:17	27	26	-1	-2.6%	0.1	Pass Low
20	6	A12 / Petrol Station Exit	N	S	6:56:55	28	28	0	0.4%	0.0	Pass Low
21	6	A12 / Petrol Station Exit	E	N	6:28:17	0	0	0		0.0	Pass Low
22	6	A12 / Petrol Station Exit	E	S	6:28:55	0	0	0		0.0	Pass Low
23	7	A12 / Petrol Station Entrance	S	N	7:17:17	27	26	-1	-2.2%	0.1	Pass Low
24	7	A12 / Petrol Station Entrance	S	E	7:17:47	0	0	0		0.0	Pass Low
25	7	A12 / Petrol Station Entrance	N	S	7:55:55	28	28	0	0.7%	0.0	Pass Low
26	7	A12 / Petrol Station Entrance	N	E	7:55:47	0	0	0		0.0	Pass Low
27	8	A12 / The St	S	N	8:33:33	27	27	0	-0.4%	0.0	Pass Low
28	8	A12 / The St	S	E	8:33:35	0	0	0		0.0	Pass Low
29	8	A12 / The St	N	S	8:34:34	27	27	0	-0.7%	0.0	Pass Low
30	8	A12 / The St	N	E	8:34:35	1	1	0	-10.0%	0.1	Pass Low
31	8	A12 / The St	E	N	8:36:33	2	2	0	-20.0%	0.3	Pass Low
32	8	A12 / The St	E	S	8:36:34	1	2	1	50.0%	0.4	Pass Low
33	9	A12 / Willow Marsh Ln	S	N	9:33:37	27	26	-1	-2.2%	0.1	Pass Low
34	9	A12 / Willow Marsh Ln	S	W	9:33:43	2	2	0	5.0%	0.1	Pass Low
35	9	A12 / Willow Marsh Ln	N	S	9:42:34	27	27	0	-0.7%	0.0	Pass Low
36	9	A12 / Willow Marsh Ln	N	W	9:42:43	0	0	0		0.0	Pass Low
37	9	A12 / Willow Marsh Ln	W	S	9:44:34	1	1	0	-10.0%	0.1	Pass Low
38	9	A12 / Willow Marsh Ln	W	N	9:44:37	0	0	0		0.0	Pass Low
39	10	A12 / Lymballs Ln	S	N	10:37:37	24	24	0	-2.1%	0.1	Pass Low
40	10	A12 / Lymballs Ln	S	E	10:37:45	3	3	0	-3.3%	0.1	Pass Low
41	10	A12 / Lymballs Ln	N	S	10:42:42	26	26	0	0.4%	0.0	Pass Low
42	10	A12 / Lymballs Ln	N	E	10:42:45	0	0	0		0.0	Pass Low
43	10	A12 / Lymballs Ln	E	N	10:46:37	0	0	0		0.0	Pass Low
44	10	A12 / Lymballs Ln	E	S	10:46:42	1	1	0	-10.0%	0.1	Pass Low
45	11	A12 / A144	S	N	11:37:38	18	18	0	0.0%	0.0	Pass Low
46	11	A12 / A144	S	W	11:37:40	6	5	-1	-10.0%	0.3	Pass Low
47	11	A12 / A144	W	N	11:41:38	0	0	0		0.0	Pass Low
48	11	A12 / A144	W	S	11:41:42	8	9	1	10.0%	0.3	Pass Low
49	11	A12 / A144	N	W	11:49:40	1	1	0	-30.0%	0.3	Pass Low
50	11	A12 / A144	N	S	11:49:42	18	17	-1	-4.4%	0.2	Pass Low

	Sum Obs.	Sum Mod.	Diff	% Diff	Ave. GEH
Overall Stats	507	500	-7	-1.4%	0.1



**Vehicle Flow Information
Calibration Statistics
LGV Vehicles
IP Peak**

Index	Junction	Name	Origin	Destination	Reference	Observed Flow	Modelled Flow	Difference	% Difference	G.E.H. Value (using hourly flows)	Flow Test (using hourly flows)
1	3	A1120 / A12	N	E	3:1:4	13	13	0	-1.5%	0.1	Pass Low
2	3	A1120 / A12	N	W	3:1:5	2	2	0	0.0%	0.0	Pass Low
3	3	A1120 / A12	W	N	3:4:3	2	2	0	-10.0%	0.1	Pass Low
4	3	A1120 / A12	W	E	3:4:4	72	71	-1	-1.2%	0.1	Pass Low
5	3	A1120 / A12	E	N	3:5:3	21	22	1	2.9%	0.1	Pass Low
6	3	A1120 / A12	E	W	3:5:5	62	63	1	1.1%	0.1	Pass Low
7	4	A12 / B1122	W	E	4:8:9	75	74	-1	-1.5%	0.1	Pass Low
8	4	A12 / B1122	W	S	4:8:10	10	10	0	2.0%	0.1	Pass Low
9	4	A12 / B1122	S	E	4:11:9	8	8	0	3.7%	0.1	Pass Low
10	4	A12 / B1122	S	W	4:11:12	16	17	1	5.0%	0.2	Pass Low
11	4	A12 / B1122	E	S	4:13:10	11	11	0	0.9%	0.0	Pass Low
12	4	A12 / B1122	E	W	4:13:12	67	68	1	1.3%	0.1	Pass Low
13	5	A12 / Westleton Rd	S	N	5:16:17	81	81	0	0.4%	0.0	Pass Low
14	5	A12 / Westleton Rd	S	E	5:16:19	2	2	-1	-25.0%	0.4	Pass Low
15	5	A12 / Westleton Rd	N	S	5:108:13	77	77	0	0.3%	0.0	Pass Low
16	5	A12 / Westleton Rd	N	E	5:108:19	1	1	0	-20.0%	0.2	Pass Low
17	5	A12 / Westleton Rd	E	S	5:20:13	1	2	1	100.0%	0.8	Pass Low
18	5	A12 / Westleton Rd	E	N	5:20:17	0	0	0		0.0	Pass Low
19	6	A12 / Petrol Station Exit	S	N	6:17:17	81	82	1	0.7%	0.1	Pass Low
20	6	A12 / Petrol Station Exit	N	S	6:56:55	72	73	0	0.7%	0.1	Pass Low
21	6	A12 / Petrol Station Exit	E	N	6:28:17	3	3	0	6.7%	0.1	Pass Low
22	6	A12 / Petrol Station Exit	E	S	6:28:55	6	6	0	0.0%	0.0	Pass Low
23	7	A12 / Petrol Station Entrance	S	N	7:17:17	76	80	3	4.6%	0.4	Pass Low
24	7	A12 / Petrol Station Entrance	S	E	7:17:47	5	5	0	8.0%	0.2	Pass Low
25	7	A12 / Petrol Station Entrance	N	S	7:55:55	72	73	1	0.7%	0.1	Pass Low
26	7	A12 / Petrol Station Entrance	N	E	7:55:47	6	6	0	-6.7%	0.2	Pass Low
27	8	A12 / The St	S	N	8:33:33	79	80	1	1.3%	0.1	Pass Low
28	8	A12 / The St	S	E	8:33:35	0	0	0		0.0	Pass Low
29	8	A12 / The St	N	S	8:34:34	77	78	1	0.6%	0.1	Pass Low
30	8	A12 / The St	N	E	8:34:35	0	0	0		0.0	Pass Low
31	8	A12 / The St	E	N	8:36:33	3	4	1	30.0%	0.5	Pass Low
32	8	A12 / The St	E	S	8:36:34	1	1	0	0.0%	0.0	Pass Low
33	9	A12 / Willow Marsh Ln	S	N	9:33:37	81	83	2	2.1%	0.2	Pass Low
34	9	A12 / Willow Marsh Ln	S	W	9:33:43	1	1	0	20.0%	0.2	Pass Low
35	9	A12 / Willow Marsh Ln	N	S	9:42:34	77	77	0	0.4%	0.0	Pass Low
36	9	A12 / Willow Marsh Ln	N	W	9:42:43	0	0	0		0.0	Pass Low
37	9	A12 / Willow Marsh Ln	W	S	9:44:34	0	0	0		0.0	Pass Low
38	9	A12 / Willow Marsh Ln	W	N	9:44:37	1	1	0	10.0%	0.1	Pass Low
39	10	A12 / Lymballs Ln	S	N	10:37:37	82	84	2	2.1%	0.2	Pass Low
40	10	A12 / Lymballs Ln	S	E	10:37:45	0	0	0		0.0	Pass Low
41	10	A12 / Lymballs Ln	N	S	10:42:42	77	77	0	-0.1%	0.0	Pass Low
42	10	A12 / Lymballs Ln	N	E	10:42:45	0	0	0		0.0	Pass Low
43	10	A12 / Lymballs Ln	E	N	10:46:37	0	0	0		0.0	Pass Low
44	10	A12 / Lymballs Ln	E	S	10:46:42	0	0	0		0.0	Pass Low
45	11	A12 / A144	S	N	11:37:38	64	66	2	2.7%	0.2	Pass Low
46	11	A12 / A144	S	W	11:37:40	18	18	0	-1.1%	0.0	Pass Low
47	11	A12 / A144	W	N	11:41:38	3	3	0	6.7%	0.1	Pass Low
48	11	A12 / A144	W	S	11:41:42	17	16	-1	-4.7%	0.2	Pass Low
49	11	A12 / A144	N	W	11:49:40	2	2	0	15.0%	0.2	Pass Low
50	11	A12 / A144	N	S	11:49:42	60	61	1	1.0%	0.1	Pass Low

	Sum Obs.	Sum Mod.	Diff	% Diff	Ave. GEH
Overall Stats	1485	1500	15	1.0%	0.1



**Vehicle Flow Information
Calibration Statistics
All Vehicles
PM Peak**

Index	Junction	Name	Origin	Destination	Reference	Observed Flow	Modelled Flow	Difference	% Difference	G.E.H. Value (using hourly flows)	Flow Test (using hourly flows)
1	3	A1120 / A12	N	E	3:1:4	131	133	2	1.3%	0.1	Pass Low
2	3	A1120 / A12	N	W	3:1:5	22	22	0	0.0%	0.0	Pass Low
3	3	A1120 / A12	W	N	3:4:3	19	19	0	-0.5%	0.0	Pass Low
4	3	A1120 / A12	W	E	3:4:4	546	546	0	0.0%	0.0	Pass Low
5	3	A1120 / A12	E	N	3:5:3	128	130	2	1.9%	0.2	Pass Low
6	3	A1120 / A12	E	W	3:5:5	361	359	-2	-0.5%	0.1	Pass Low
7	4	A12 / B1122	W	E	4:8:9	614	616	2	0.4%	0.1	Pass Low
8	4	A12 / B1122	W	S	4:8:10	63	63	0	-0.6%	0.1	Pass Low
9	4	A12 / B1122	S	E	4:11:9	64	67	3	4.4%	0.3	Pass Low
10	4	A12 / B1122	S	W	4:11:12	55	56	1	1.6%	0.1	Pass Low
11	4	A12 / B1122	E	S	4:13:10	64	64	0	-0.5%	0.0	Pass Low
12	4	A12 / B1122	E	W	4:13:12	434	432	-2	-0.5%	0.1	Pass Low
13	5	A12 / Westleton Rd	S	N	5:16:17	652	660	7	1.2%	0.3	Pass Low
14	5	A12 / Westleton Rd	S	E	5:16:19	26	27	0	1.9%	0.1	Pass Low
15	5	A12 / Westleton Rd	N	S	5:108:13	469	463	-6	-1.2%	0.3	Pass Low
16	5	A12 / Westleton Rd	N	E	5:108:19	4	4	0	-7.5%	0.2	Pass Low
17	5	A12 / Westleton Rd	E	S	5:20:13	29	29	0	-1.0%	0.1	Pass Low
18	5	A12 / Westleton Rd	E	N	5:20:17	7	8	1	7.1%	0.2	Pass Low
19	6	A12 / Petrol Station Exit	S	N	6:17:17	659	668	9	1.4%	0.4	Pass Low
20	6	A12 / Petrol Station Exit	N	S	6:56:55	446	448	2	0.5%	0.1	Pass Low
21	6	A12 / Petrol Station Exit	E	N	6:28:17	21	20	-1	-3.8%	0.2	Pass Low
22	6	A12 / Petrol Station Exit	E	S	6:28:55	27	27	0	-0.4%	0.0	Pass Low
23	7	A12 / Petrol Station Entrance	S	N	7:17:17	635	663	28	4.4%	1.1	Pass Low
24	7	A12 / Petrol Station Entrance	S	E	7:17:47	24	25	1	5.4%	0.3	Pass Low
25	7	A12 / Petrol Station Entrance	N	S	7:55:55	446	448	2	0.5%	0.1	Pass Low
26	7	A12 / Petrol Station Entrance	N	E	7:55:47	29	29	0	-0.3%	0.0	Pass Low
27	8	A12 / The St	S	N	8:33:33	642	645	3	0.5%	0.1	Pass Low
28	8	A12 / The St	S	E	8:33:35	14	14	0	1.4%	0.1	Pass Low
29	8	A12 / The St	N	S	8:34:34	462	463	1	0.2%	0.0	Pass Low
30	8	A12 / The St	N	E	8:34:35	11	11	-1	-4.5%	0.2	Pass Low
31	8	A12 / The St	E	N	8:36:33	9	9	-1	-5.6%	0.2	Pass Low
32	8	A12 / The St	E	S	8:36:34	13	14	1	6.2%	0.2	Pass Low
33	9	A12 / Willow Marsh Ln	S	N	9:33:37	645	649	4	0.7%	0.2	Pass Low
34	9	A12 / Willow Marsh Ln	S	W	9:33:43	6	6	0	0.0%	0.0	Pass Low
35	9	A12 / Willow Marsh Ln	N	S	9:42:34	472	472	0	0.1%	0.0	Pass Low
36	9	A12 / Willow Marsh Ln	N	W	9:42:43	2	2	0	-10.0%	0.1	Pass Low
37	9	A12 / Willow Marsh Ln	W	S	9:44:34	1	1	0	20.0%	0.2	Pass Low
38	9	A12 / Willow Marsh Ln	W	N	9:44:37	3	4	1	36.7%	0.6	Pass Low
39	10	A12 / Lymballs Ln	S	N	10:37:37	647	659	12	1.8%	0.5	Pass Low
40	10	A12 / Lymballs Ln	S	E	10:37:45	1	1	0	-10.0%	0.1	Pass Low
41	10	A12 / Lymballs Ln	N	S	10:42:42	473	473	0	-0.1%	0.0	Pass Low
42	10	A12 / Lymballs Ln	N	E	10:42:45	3	3	0	0.0%	0.0	Pass Low
43	10	A12 / Lymballs Ln	E	N	10:46:37	5	5	0	-4.0%	0.1	Pass Low
44	10	A12 / Lymballs Ln	E	S	10:46:42	1	1	0	-40.0%	0.4	Pass Low
45	11	A12 / A144	S	N	11:37:38	516	523	7	1.3%	0.3	Pass Low
46	11	A12 / A144	S	W	11:37:40	136	145	9	6.5%	0.7	Pass Low
47	11	A12 / A144	W	N	11:41:38	14	14	0	0.7%	0.0	Pass Low
48	11	A12 / A144	W	S	11:41:42	103	103	0	-0.4%	0.0	Pass Low
49	11	A12 / A144	N	W	11:49:40	22	22	0	-0.5%	0.0	Pass Low
50	11	A12 / A144	N	S	11:49:42	373	372	-1	-0.4%	0.1	Pass Low

	Sum Obs.	Sum Mod.	Diff	% Diff	Ave. GEH
Overall Stats	10549	10633	83	0.8%	0.2



**Vehicle Flow Information
Calibration Statistics
Car Vehicles
PM Peak**

Index	Junction	Name	Origin	Destination	Reference	Observed Flow	Modelled Flow	Difference	% Difference	G.E.H. Value (using hourly flows)	Flow Test (using hourly flows)
1	3	A1120 / A12	N	E	3:1:4	111	112	1	1.1%	0.1	Pass Low
2	3	A1120 / A12	N	W	3:1:5	21	21	0	-1.0%	0.0	Pass Low
3	3	A1120 / A12	W	N	3:4:3	18	18	0	-2.2%	0.1	Pass Low
4	3	A1120 / A12	W	E	3:4:4	478	478	0	0.0%	0.0	Pass Low
5	3	A1120 / A12	E	N	3:5:3	107	110	3	2.5%	0.3	Pass Low
6	3	A1120 / A12	E	W	3:5:5	316	313	-3	-0.9%	0.2	Pass Low
7	4	A12 / B1122	W	E	4:8:9	532	534	2	0.5%	0.1	Pass Low
8	4	A12 / B1122	W	S	4:8:10	57	57	0	-0.7%	0.1	Pass Low
9	4	A12 / B1122	S	E	4:11:9	55	57	2	3.8%	0.3	Pass Low
10	4	A12 / B1122	S	W	4:11:12	46	47	1	2.0%	0.1	Pass Low
11	4	A12 / B1122	E	S	4:13:10	59	58	-1	-1.4%	0.1	Pass Low
12	4	A12 / B1122	E	W	4:13:12	377	374	-3	-0.8%	0.1	Pass Low
13	5	A12 / Westleton Rd	S	N	5:16:17	562	569	7	1.2%	0.3	Pass Low
14	5	A12 / Westleton Rd	S	E	5:16:19	25	25	0	0.4%	0.0	Pass Low
15	5	A12 / Westleton Rd	N	S	5:108:13	410	403	-7	-1.7%	0.4	Pass Low
16	5	A12 / Westleton Rd	N	E	5:108:19	4	4	0	-7.5%	0.2	Pass Low
17	5	A12 / Westleton Rd	E	S	5:20:13	26	27	1	1.9%	0.1	Pass Low
18	5	A12 / Westleton Rd	E	N	5:20:17	7	8	1	7.1%	0.2	Pass Low
19	6	A12 / Petrol Station Exit	S	N	6:17:17	569	577	8	1.4%	0.3	Pass Low
20	6	A12 / Petrol Station Exit	N	S	6:56:55	392	393	1	0.2%	0.0	Pass Low
21	6	A12 / Petrol Station Exit	E	N	6:28:17	19	18	-1	-4.2%	0.2	Pass Low
22	6	A12 / Petrol Station Exit	E	S	6:28:55	22	22	0	0.0%	0.0	Pass Low
23	7	A12 / Petrol Station Entrance	S	N	7:17:17	548	573	25	4.6%	1.1	Pass Low
24	7	A12 / Petrol Station Entrance	S	E	7:17:47	21	22	1	3.8%	0.2	Pass Low
25	7	A12 / Petrol Station Entrance	N	S	7:55:55	392	393	1	0.2%	0.0	Pass Low
26	7	A12 / Petrol Station Entrance	N	E	7:55:47	23	23	0	0.9%	0.0	Pass Low
27	8	A12 / The St	S	N	8:33:33	553	555	2	0.3%	0.1	Pass Low
28	8	A12 / The St	S	E	8:33:35	14	14	0	1.4%	0.1	Pass Low
29	8	A12 / The St	N	S	8:34:34	402	402	0	0.0%	0.0	Pass Low
30	8	A12 / The St	N	E	8:34:35	11	11	-1	-4.5%	0.2	Pass Low
31	8	A12 / The St	E	N	8:36:33	8	7	-1	-7.5%	0.2	Pass Low
32	8	A12 / The St	E	S	8:36:34	13	14	1	4.6%	0.2	Pass Low
33	9	A12 / Willow Marsh Ln	S	N	9:33:37	558	561	3	0.5%	0.1	Pass Low
34	9	A12 / Willow Marsh Ln	S	W	9:33:43	3	3	0	-3.3%	0.1	Pass Low
35	9	A12 / Willow Marsh Ln	N	S	9:42:34	412	412	0	-0.1%	0.0	Pass Low
36	9	A12 / Willow Marsh Ln	N	W	9:42:43	1	1	0	-10.0%	0.1	Pass Low
37	9	A12 / Willow Marsh Ln	W	S	9:44:34	1	1	0	20.0%	0.2	Pass Low
38	9	A12 / Willow Marsh Ln	W	N	9:44:37	1	2	1	80.0%	0.7	Pass Low
39	10	A12 / Lymballs Ln	S	N	10:37:37	558	567	9	1.7%	0.4	Pass Low
40	10	A12 / Lymballs Ln	S	E	10:37:45	1	1	0	-10.0%	0.1	Pass Low
41	10	A12 / Lymballs Ln	N	S	10:42:42	412	411	-1	-0.3%	0.1	Pass Low
42	10	A12 / Lymballs Ln	N	E	10:42:45	2	2	0	-5.0%	0.1	Pass Low
43	10	A12 / Lymballs Ln	E	N	10:46:37	5	5	0	-4.0%	0.1	Pass Low
44	10	A12 / Lymballs Ln	E	S	10:46:42	1	1	0	-40.0%	0.4	Pass Low
45	11	A12 / A144	S	N	11:37:38	439	444	5	1.1%	0.2	Pass Low
46	11	A12 / A144	S	W	11:37:40	124	132	8	6.3%	0.7	Pass Low
47	11	A12 / A144	W	N	11:41:38	12	12	0	0.8%	0.0	Pass Low
48	11	A12 / A144	W	S	11:41:42	82	81	-1	-0.7%	0.1	Pass Low
49	11	A12 / A144	N	W	11:49:40	16	16	0	0.0%	0.0	Pass Low
50	11	A12 / A144	N	S	11:49:42	332	330	-2	-0.5%	0.1	Pass Low

	Sum Obs.	Sum Mod.	Diff	% Diff	Ave. GEH
Overall Stats	9158	9218	60	0.7%	0.2



**Vehicle Flow Information
Calibration Statistics
HGV Vehicles
PM Peak**

Index	Junction	Name	Origin	Destination	Reference	Observed Flow	Modelled Flow	Difference	% Difference	G.E.H. Value (using hourly flows)	Flow Test (using hourly flows)
1	3	A1120 / A12	N	E	3:1:4	0	0	0		0.4	Pass Low
2	3	A1120 / A12	N	W	3:1:5	0	0	0		0.0	Pass Low
3	3	A1120 / A12	W	N	3:4:3	0	0	0		0.0	Pass Low
4	3	A1120 / A12	W	E	3:4:4	10	10	0	-1.0%	0.0	Pass Low
5	3	A1120 / A12	E	N	3:5:3	0	0	0		0.9	Pass Low
6	3	A1120 / A12	E	W	3:5:5	8	9	1	15.0%	0.4	Pass Low
7	4	A12 / B1122	W	E	4:8:9	9	9	0	-3.3%	0.1	Pass Low
8	4	A12 / B1122	W	S	4:8:10	1	1	0	30.0%	0.3	Pass Low
9	4	A12 / B1122	S	E	4:11:9	1	1	0	20.0%	0.2	Pass Low
10	4	A12 / B1122	S	W	4:11:12	0	0	0		0.6	Pass Low
11	4	A12 / B1122	E	S	4:13:10	0	0	0		0.4	Pass Low
12	4	A12 / B1122	E	W	4:13:12	8	10	2	18.8%	0.5	Pass Low
13	5	A12 / Westleton Rd	S	N	5:16:17	10	10	0	3.0%	0.1	Pass Low
14	5	A12 / Westleton Rd	S	E	5:16:19	0	0	0		0.0	Pass Low
15	5	A12 / Westleton Rd	N	S	5:108:13	8	10	2	20.0%	0.5	Pass Low
16	5	A12 / Westleton Rd	N	E	5:108:19	0	0	0		0.0	Pass Low
17	5	A12 / Westleton Rd	E	S	5:20:13	0	0	0		0.0	Pass Low
18	5	A12 / Westleton Rd	E	N	5:20:17	0	0	0		0.0	Pass Low
19	6	A12 / Petrol Station Exit	S	N	6:17:17	10	11	1	6.0%	0.2	Pass Low
20	6	A12 / Petrol Station Exit	N	S	6:56:55	8	10	2	18.8%	0.5	Pass Low
21	6	A12 / Petrol Station Exit	E	N	6:28:17	0	0	0		0.0	Pass Low
22	6	A12 / Petrol Station Exit	E	S	6:28:55	0	0	0		0.0	Pass Low
23	7	A12 / Petrol Station Entrance	S	N	7:17:17	10	11	1	6.0%	0.2	Pass Low
24	7	A12 / Petrol Station Entrance	S	E	7:17:47	0	0	0		0.0	Pass Low
25	7	A12 / Petrol Station Entrance	N	S	7:55:55	8	10	2	18.8%	0.5	Pass Low
26	7	A12 / Petrol Station Entrance	N	E	7:55:47	0	0	0		0.0	Pass Low
27	8	A12 / The St	S	N	8:33:33	10	11	1	10.0%	0.3	Pass Low
28	8	A12 / The St	S	E	8:33:35	0	0	0		0.0	Pass Low
29	8	A12 / The St	N	S	8:34:34	8	9	1	13.8%	0.4	Pass Low
30	8	A12 / The St	N	E	8:34:35	0	0	0		0.0	Pass Low
31	8	A12 / The St	E	N	8:36:33	0	0	0		0.0	Pass Low
32	8	A12 / The St	E	S	8:36:34	0	0	0		0.0	Pass Low
33	9	A12 / Willow Marsh Ln	S	N	9:33:37	7	8	1	15.7%	0.4	Pass Low
34	9	A12 / Willow Marsh Ln	S	W	9:33:43	3	3	0	3.3%	0.1	Pass Low
35	9	A12 / Willow Marsh Ln	N	S	9:42:34	8	9	1	11.3%	0.3	Pass Low
36	9	A12 / Willow Marsh Ln	N	W	9:42:43	0	0	0		0.0	Pass Low
37	9	A12 / Willow Marsh Ln	W	S	9:44:34	0	0	0		0.0	Pass Low
38	9	A12 / Willow Marsh Ln	W	N	9:44:37	0	0	0		0.0	Pass Low
39	10	A12 / Lymballs Ln	S	N	10:37:37	7	8	1	15.7%	0.4	Pass Low
40	10	A12 / Lymballs Ln	S	E	10:37:45	0	0	0		0.0	Pass Low
41	10	A12 / Lymballs Ln	N	S	10:42:42	8	9	1	10.0%	0.3	Pass Low
42	10	A12 / Lymballs Ln	N	E	10:42:45	1	1	0	10.0%	0.1	Pass Low
43	10	A12 / Lymballs Ln	E	N	10:46:37	0	0	0		0.0	Pass Low
44	10	A12 / Lymballs Ln	E	S	10:46:42	0	0	0		0.0	Pass Low
45	11	A12 / A144	S	N	11:37:38	5	6	1	26.0%	0.5	Pass Low
46	11	A12 / A144	S	W	11:37:40	2	2	0	10.0%	0.1	Pass Low
47	11	A12 / A144	W	N	11:41:38	1	1	0	0.0%	0.0	Pass Low
48	11	A12 / A144	W	S	11:41:42	1	1	0	10.0%	0.1	Pass Low
49	11	A12 / A144	N	W	11:49:40	0	0	0		0.0	Pass Low
50	11	A12 / A144	N	S	11:49:42	8	9	1	6.3%	0.2	Pass Low

	Sum Obs.	Sum Mod.	Diff	% Diff	Ave. GEH
Overall Stats	160	178	18	11.3%	0.2



**Vehicle Flow Information
Calibration Statistics
LGV Vehicles
PM Peak**

Index	Junction	Name	Origin	Destination	Reference	Observed Flow	Modelled Flow	Difference	% Difference	G.E.H. Value (using hourly flows)	Flow Test (using hourly flows)
1	3	A1120 / A12	N	E	3:1:4	20	20	0	2.0%	0.1	Pass Low
2	3	A1120 / A12	N	W	3:1:5	1	1	0	20.0%	0.2	Pass Low
3	3	A1120 / A12	W	N	3:4:3	1	1	0	30.0%	0.3	Pass Low
4	3	A1120 / A12	W	E	3:4:4	58	58	0	-0.5%	0.0	Pass Low
5	3	A1120 / A12	E	N	3:5:3	21	20	-1	-3.3%	0.2	Pass Low
6	3	A1120 / A12	E	W	3:5:5	37	37	0	0.3%	0.0	Pass Low
7	4	A12 / B1122	W	E	4:8:9	73	73	0	0.3%	0.0	Pass Low
8	4	A12 / B1122	W	S	4:8:10	5	5	0	-6.0%	0.1	Pass Low
9	4	A12 / B1122	S	E	4:11:9	8	9	1	6.3%	0.2	Pass Low
10	4	A12 / B1122	S	W	4:11:12	9	9	0	-2.2%	0.1	Pass Low
11	4	A12 / B1122	E	S	4:13:10	5	5	0	8.0%	0.2	Pass Low
12	4	A12 / B1122	E	W	4:13:12	49	48	-1	-1.4%	0.1	Pass Low
13	5	A12 / Westleton Rd	S	N	5:16:17	80	80	0	0.5%	0.0	Pass Low
14	5	A12 / Westleton Rd	S	E	5:16:19	1	1	0	40.0%	0.4	Pass Low
15	5	A12 / Westleton Rd	N	S	5:108:13	51	51	0	-0.6%	0.0	Pass Low
16	5	A12 / Westleton Rd	N	E	5:108:19	0	0	0		0.0	Pass Low
17	5	A12 / Westleton Rd	E	S	5:20:13	3	2	-1	-26.7%	0.5	Pass Low
18	5	A12 / Westleton Rd	E	N	5:20:17	0	0	0		0.0	Pass Low
19	6	A12 / Petrol Station Exit	S	N	6:17:17	80	81	1	1.0%	0.1	Pass Low
20	6	A12 / Petrol Station Exit	N	S	6:56:55	46	46	0	0.2%	0.0	Pass Low
21	6	A12 / Petrol Station Exit	E	N	6:28:17	2	2	0	0.0%	0.0	Pass Low
22	6	A12 / Petrol Station Exit	E	S	6:28:55	5	5	0	-2.0%	0.0	Pass Low
23	7	A12 / Petrol Station Entrance	S	N	7:17:17	77	79	2	2.9%	0.2	Pass Low
24	7	A12 / Petrol Station Entrance	S	E	7:17:47	3	4	1	16.7%	0.3	Pass Low
25	7	A12 / Petrol Station Entrance	N	S	7:55:55	46	46	0	0.0%	0.0	Pass Low
26	7	A12 / Petrol Station Entrance	N	E	7:55:47	6	6	0	-5.0%	0.1	Pass Low
27	8	A12 / The St	S	N	8:33:33	79	79	0	0.3%	0.0	Pass Low
28	8	A12 / The St	S	E	8:33:35	0	0	0		0.0	Pass Low
29	8	A12 / The St	N	S	8:34:34	52	52	-1	-1.0%	0.1	Pass Low
30	8	A12 / The St	N	E	8:34:35	0	0	0		0.0	Pass Low
31	8	A12 / The St	E	N	8:36:33	1	1	0	10.0%	0.1	Pass Low
32	8	A12 / The St	E	S	8:36:34	0	0	0		0.6	Pass Low
33	9	A12 / Willow Marsh Ln	S	N	9:33:37	80	80	0	0.5%	0.0	Pass Low
34	9	A12 / Willow Marsh Ln	S	W	9:33:43	0	0	0		0.0	Pass Low
35	9	A12 / Willow Marsh Ln	N	S	9:42:34	52	52	0	-0.4%	0.0	Pass Low
36	9	A12 / Willow Marsh Ln	N	W	9:42:43	1	1	0	-10.0%	0.1	Pass Low
37	9	A12 / Willow Marsh Ln	W	S	9:44:34	0	0	0		0.0	Pass Low
38	9	A12 / Willow Marsh Ln	W	N	9:44:37	2	2	0	15.0%	0.2	Pass Low
39	10	A12 / Lymballs Ln	S	N	10:37:37	82	83	1	1.5%	0.1	Pass Low
40	10	A12 / Lymballs Ln	S	E	10:37:45	0	0	0		0.0	Pass Low
41	10	A12 / Lymballs Ln	N	S	10:42:42	53	53	0	-0.2%	0.0	Pass Low
42	10	A12 / Lymballs Ln	N	E	10:42:45	0	0	0		0.0	Pass Low
43	10	A12 / Lymballs Ln	E	N	10:46:37	0	0	0		0.0	Pass Low
44	10	A12 / Lymballs Ln	E	S	10:46:42	0	0	0		0.0	Pass Low
45	11	A12 / A144	S	N	11:37:38	72	73	0	0.7%	0.1	Pass Low
46	11	A12 / A144	S	W	11:37:40	10	11	1	8.0%	0.2	Pass Low
47	11	A12 / A144	W	N	11:41:38	1	1	0	0.0%	0.0	Pass Low
48	11	A12 / A144	W	S	11:41:42	20	20	0	0.5%	0.0	Pass Low
49	11	A12 / A144	N	W	11:49:40	6	6	0	-1.7%	0.0	Pass Low
50	11	A12 / A144	N	S	11:49:42	33	33	0	-1.2%	0.1	Pass Low

	Sum Obs.	Sum Mod.	Diff	% Diff	Ave. GEH
Overall Stats	1231	1236	5	0.4%	0.1



Queue Graphs

Junction Number 3
AM Peak

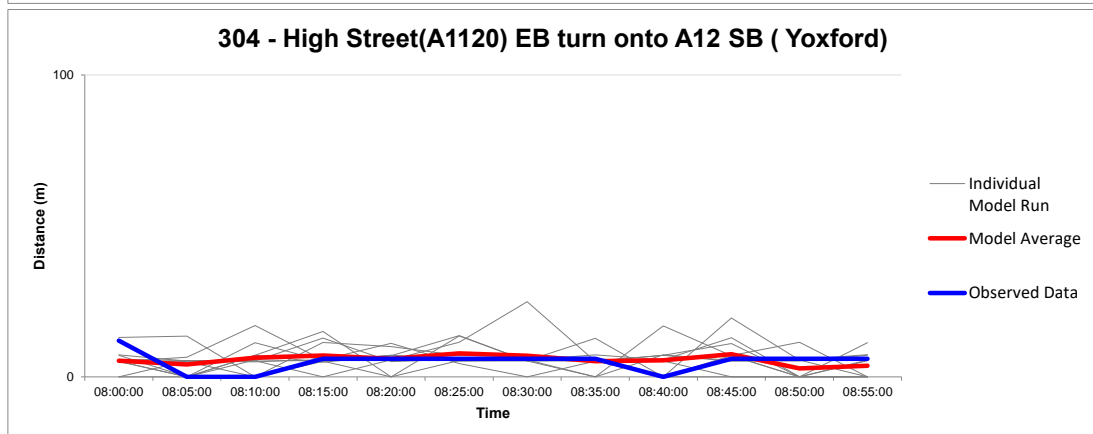
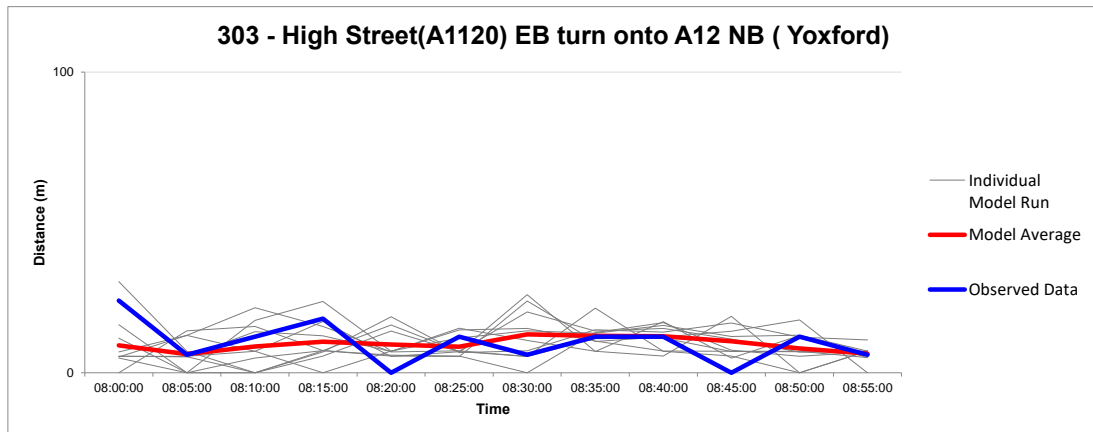
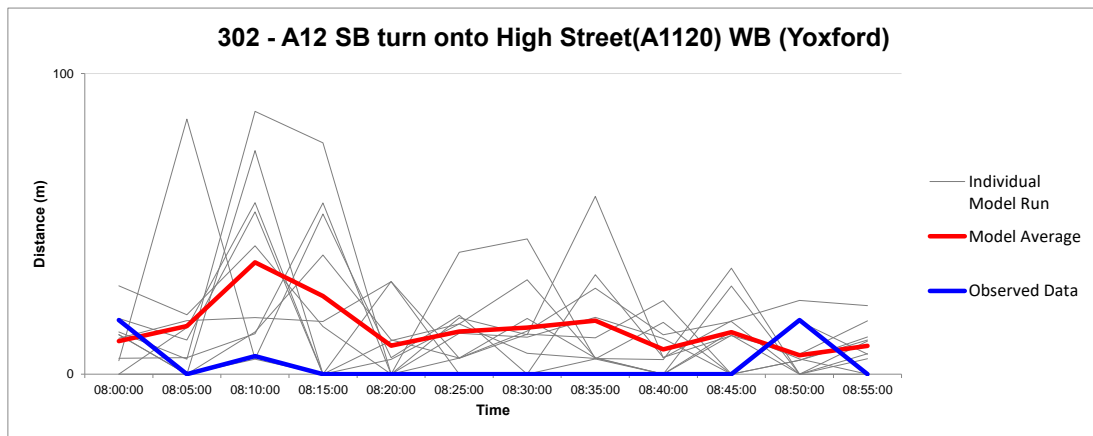
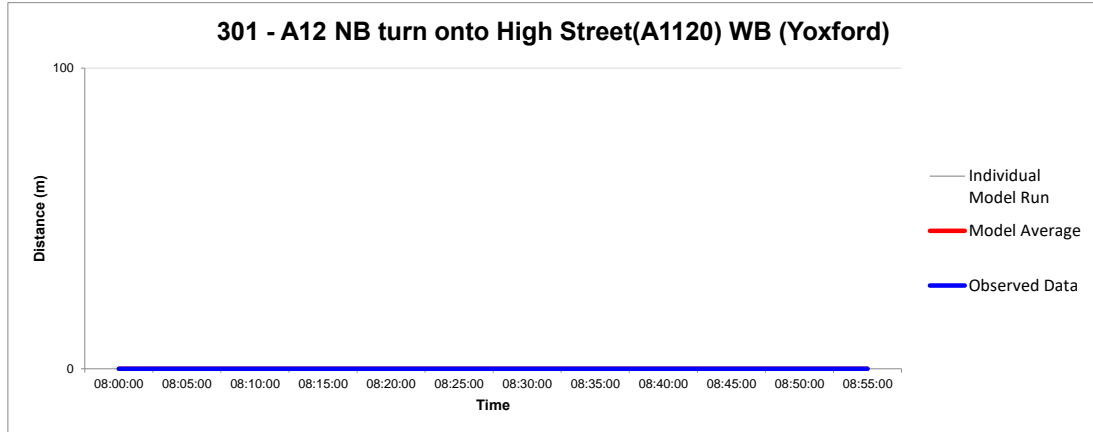



Queue Graphs

Junction Number 4
AM Peak

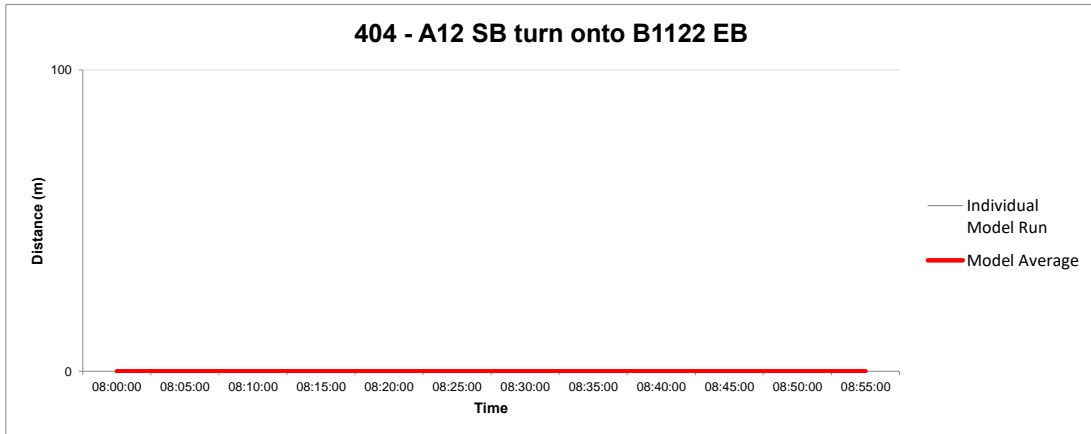
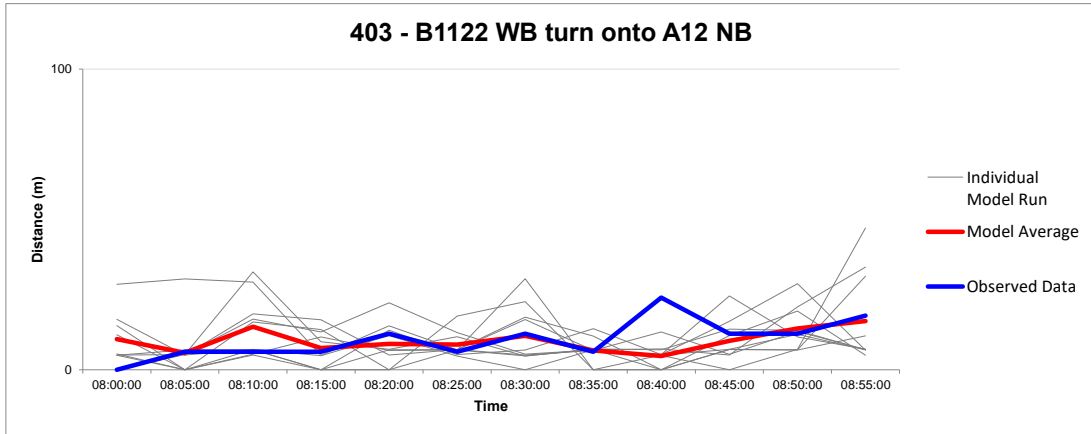
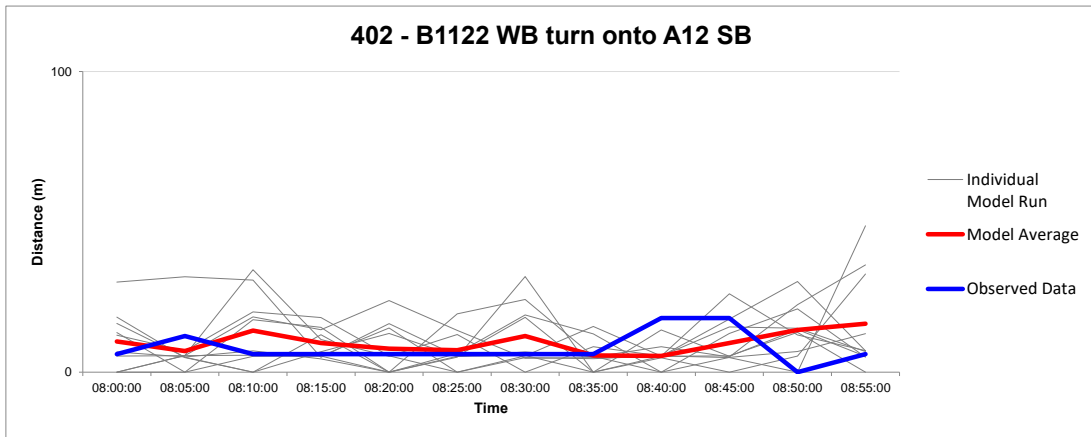
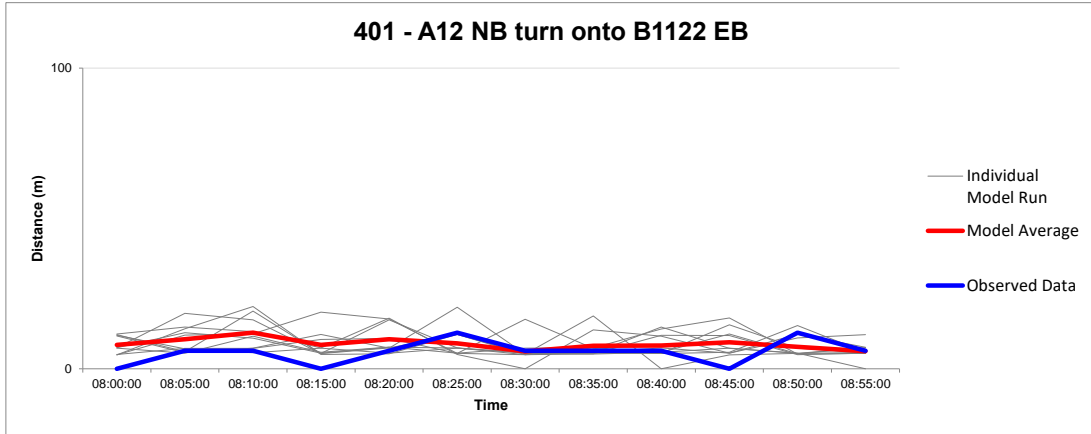



Queue Graphs

Junction Number 5
AM Peak

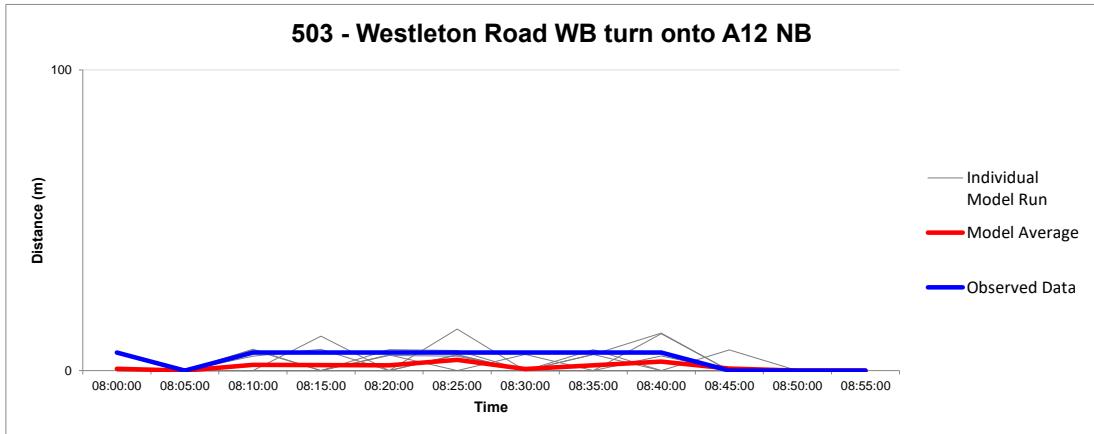
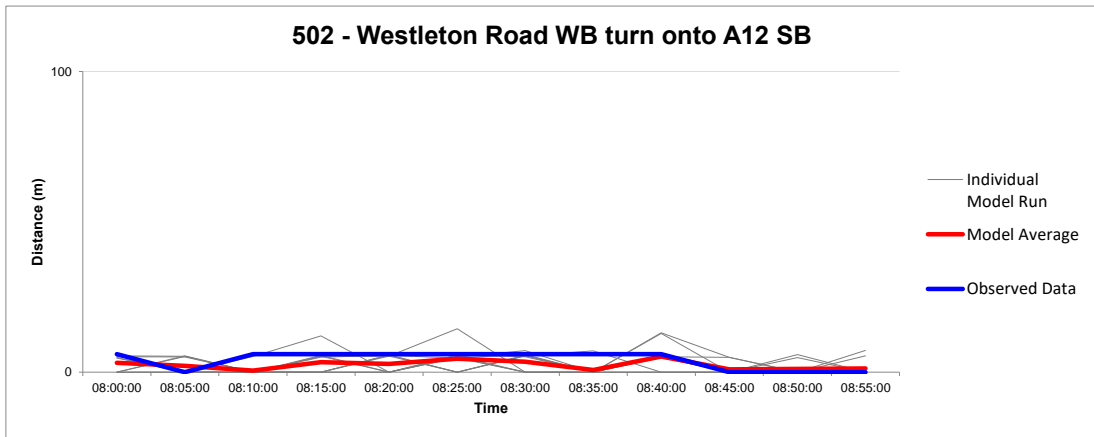
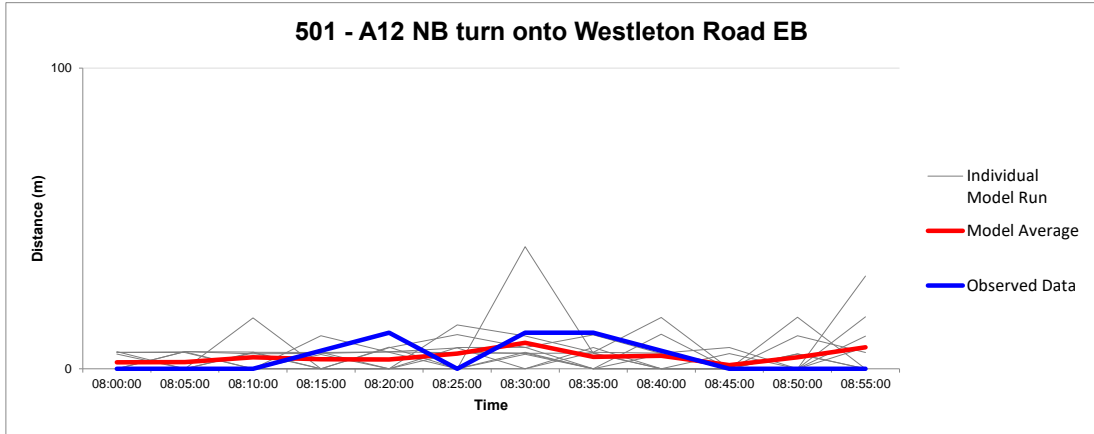



Queue Graphs

Junction Number 6
AM Peak

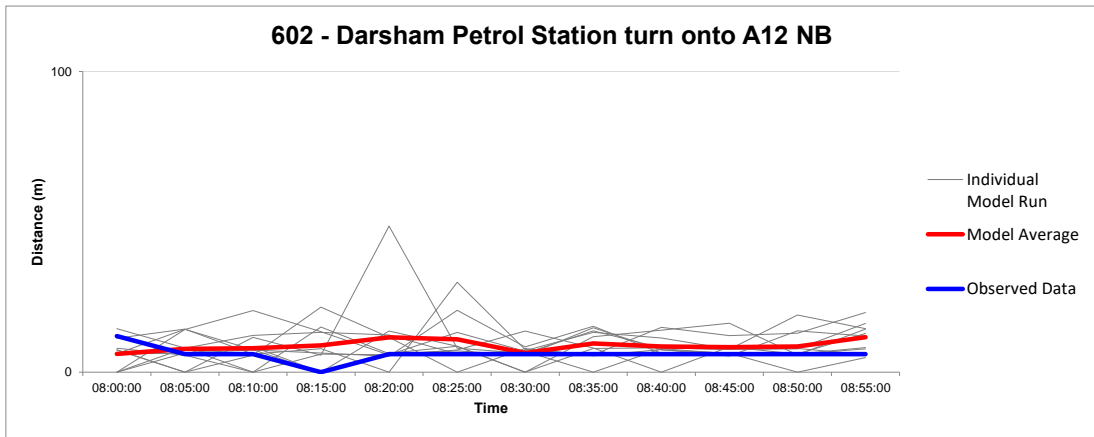
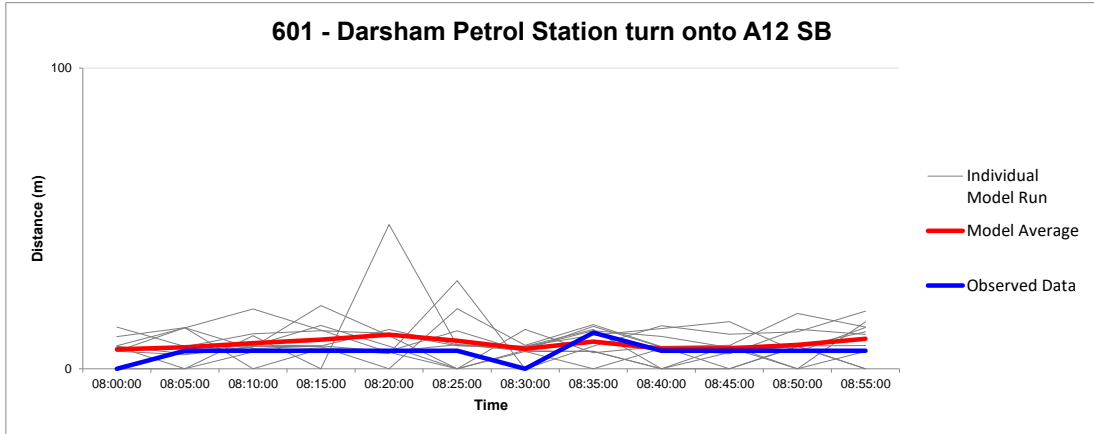



Queue Graphs

Junction Number 7
AM Peak

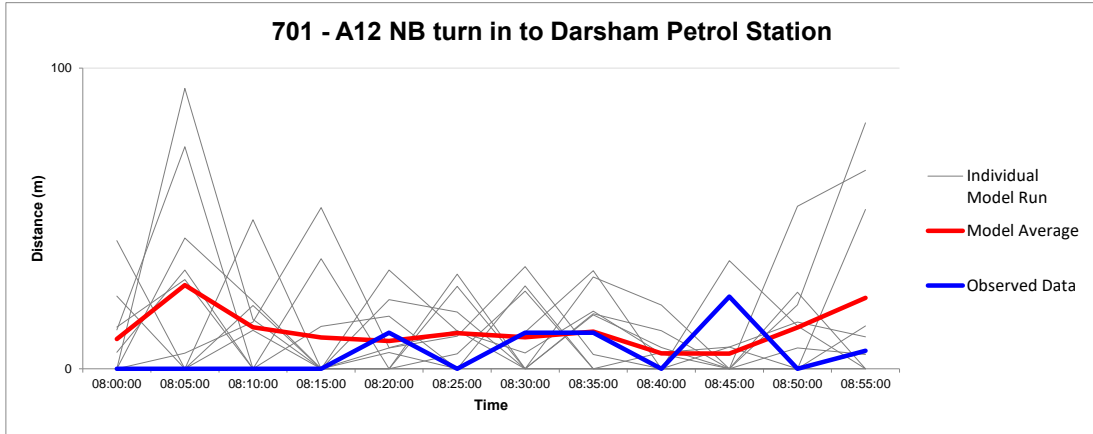



Queue Graphs

Junction Number 8
AM Peak

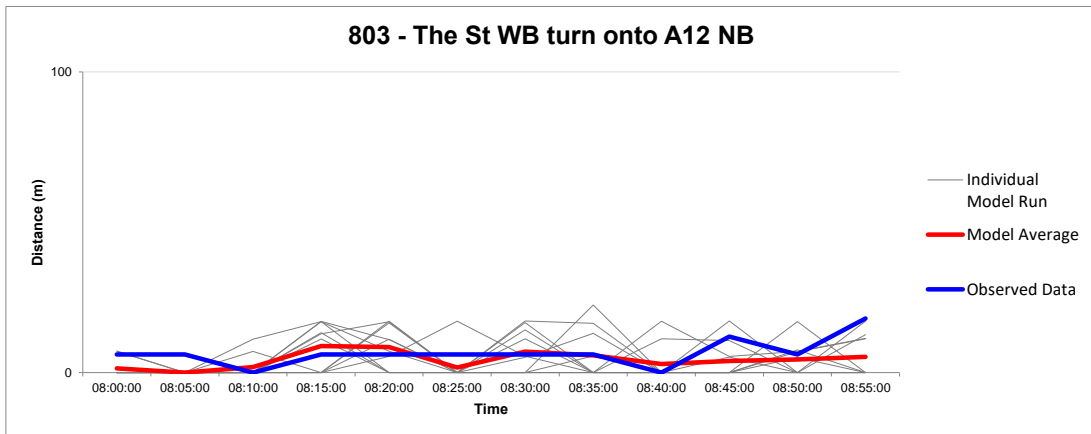
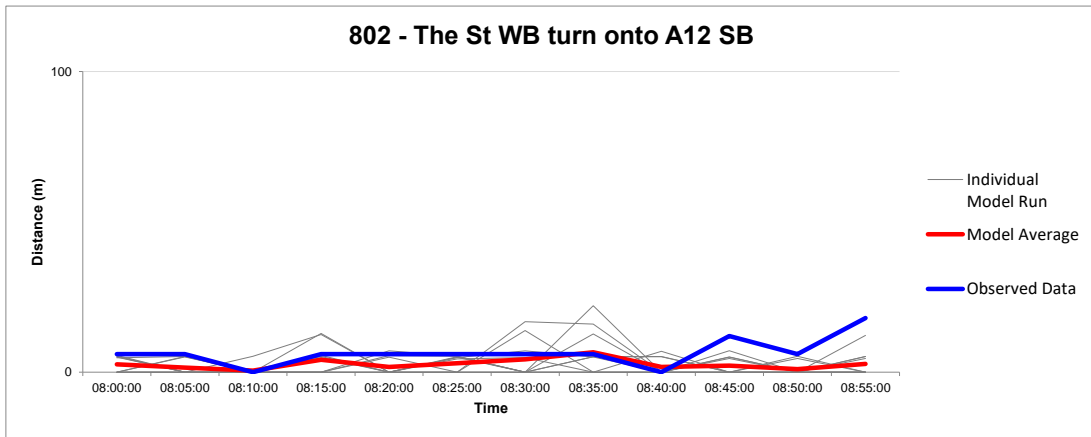
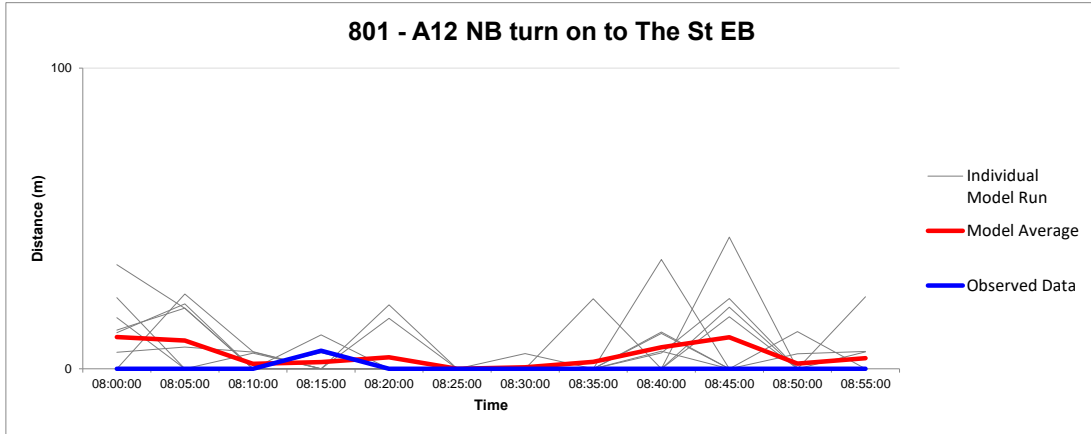



Queue Graphs

Junction Number 9
AM Peak

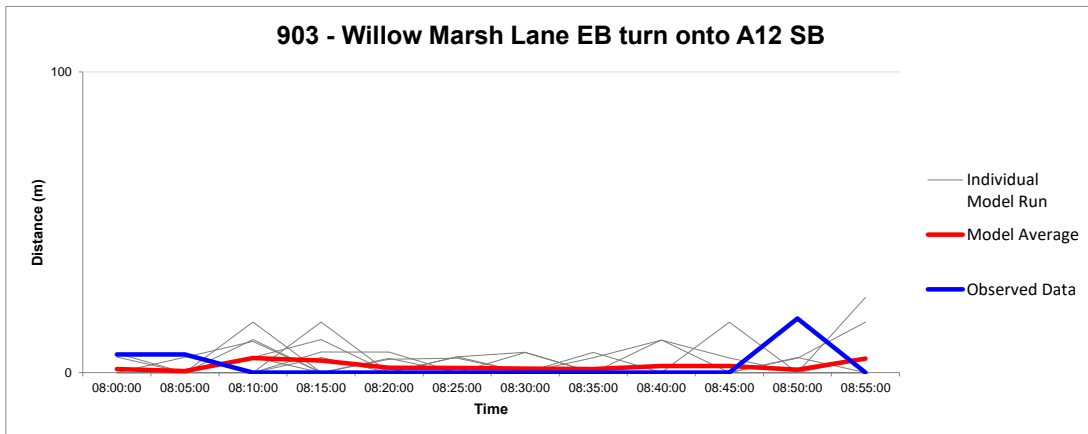
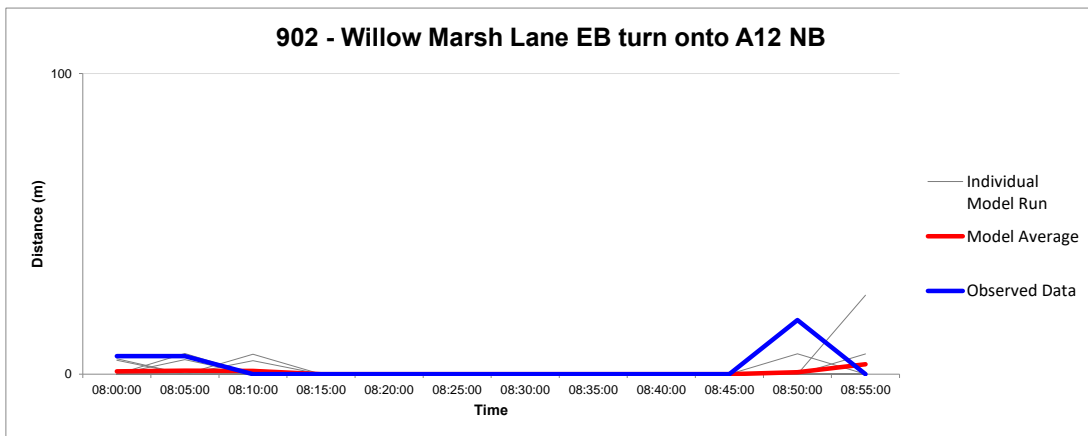
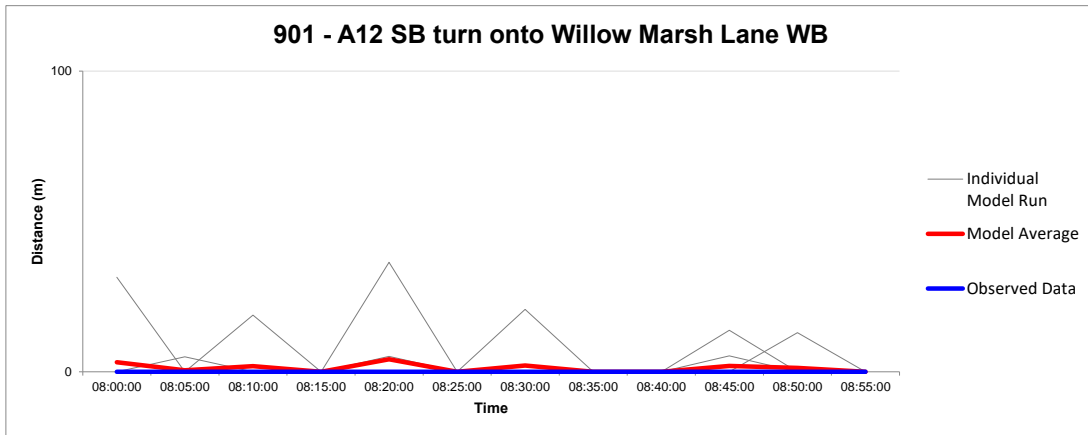



Queue Graphs

Junction Number 10
AM Peak

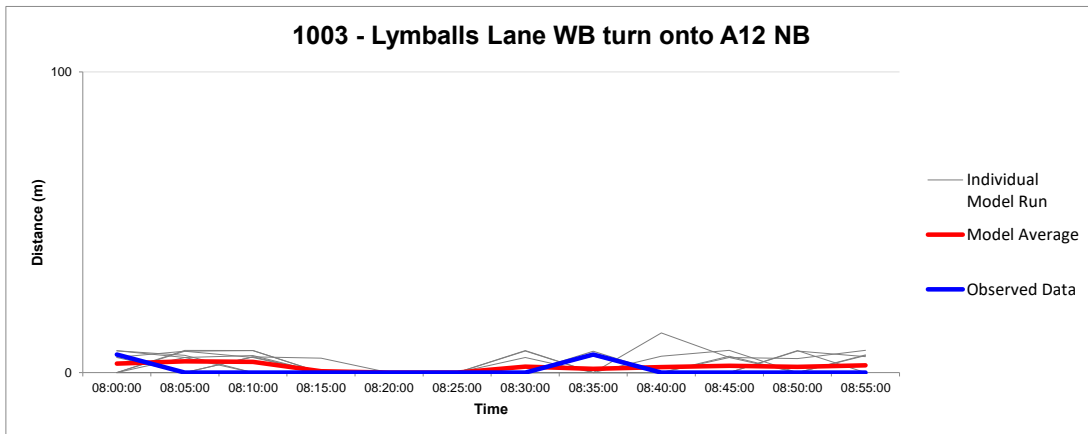
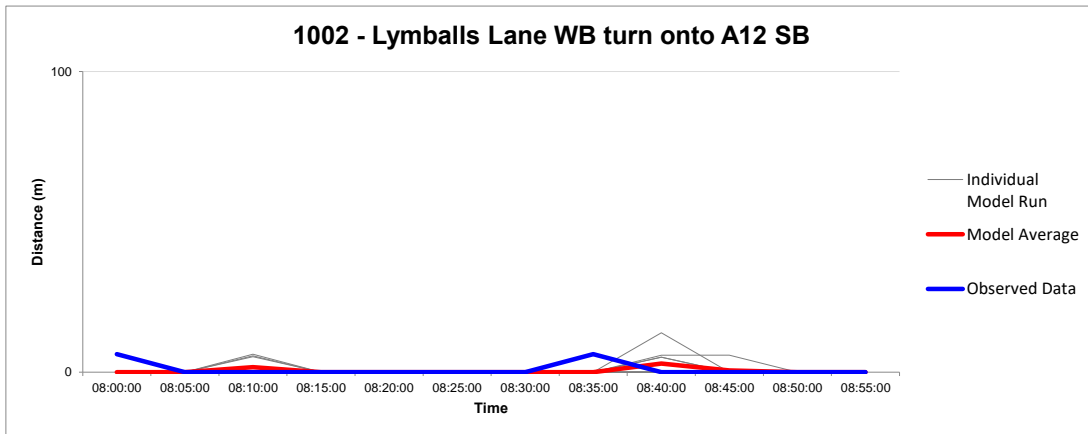
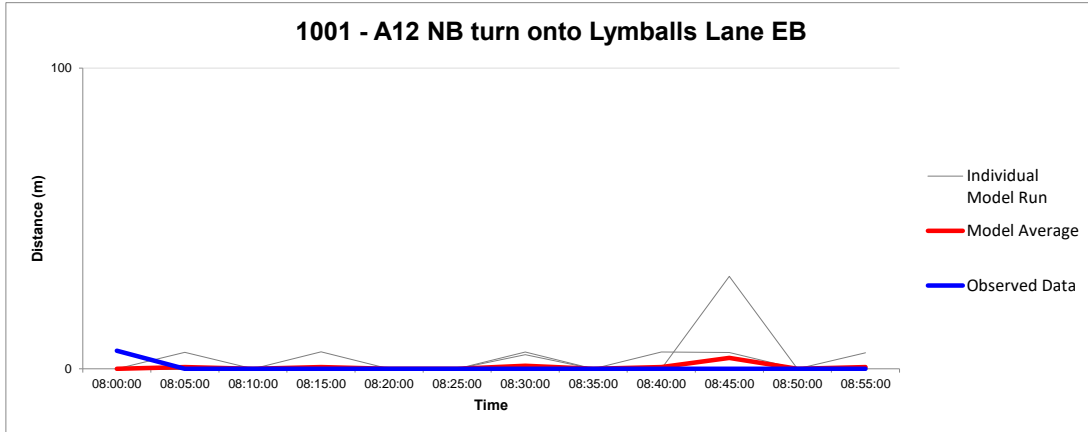



Queue Graphs

Junction Number 11
AM Peak

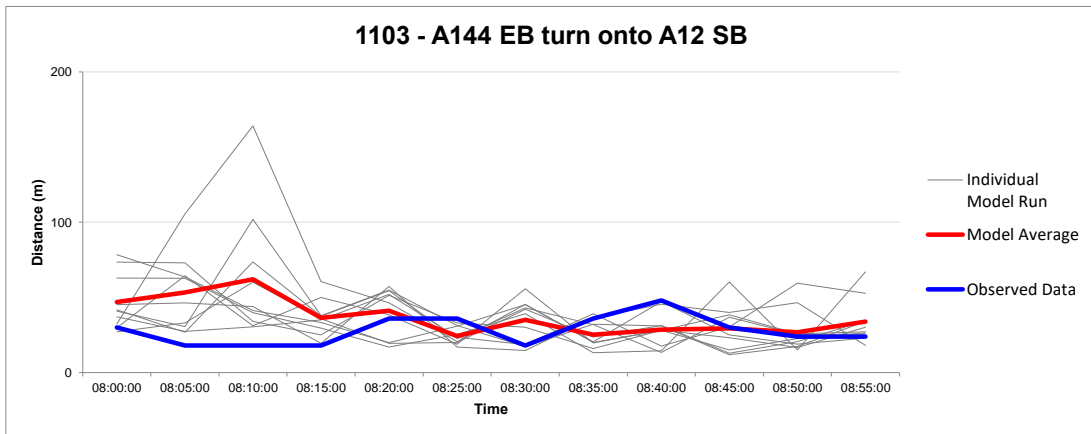
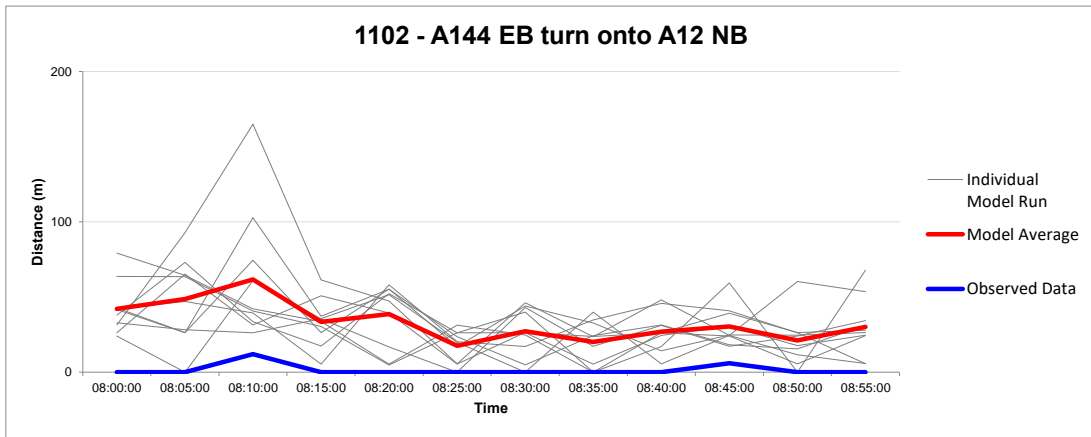
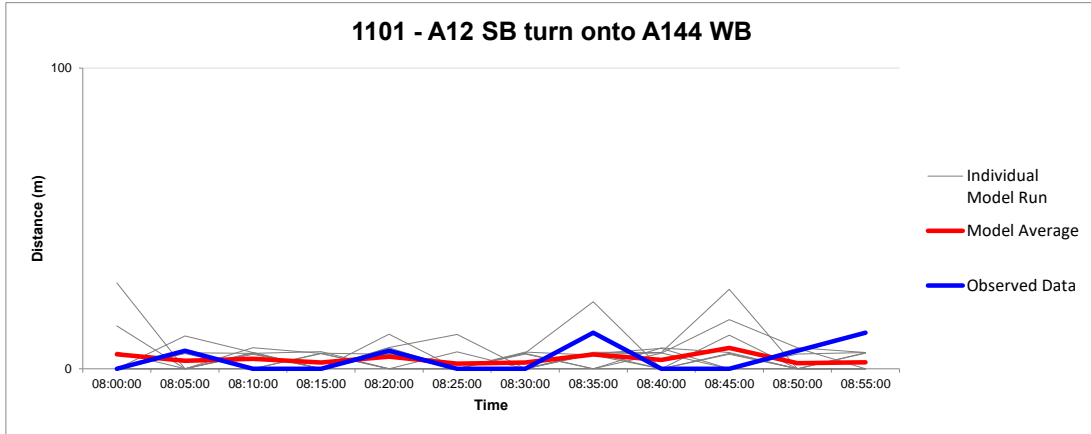



Queue Graphs

Junction Number 12
AM Peak

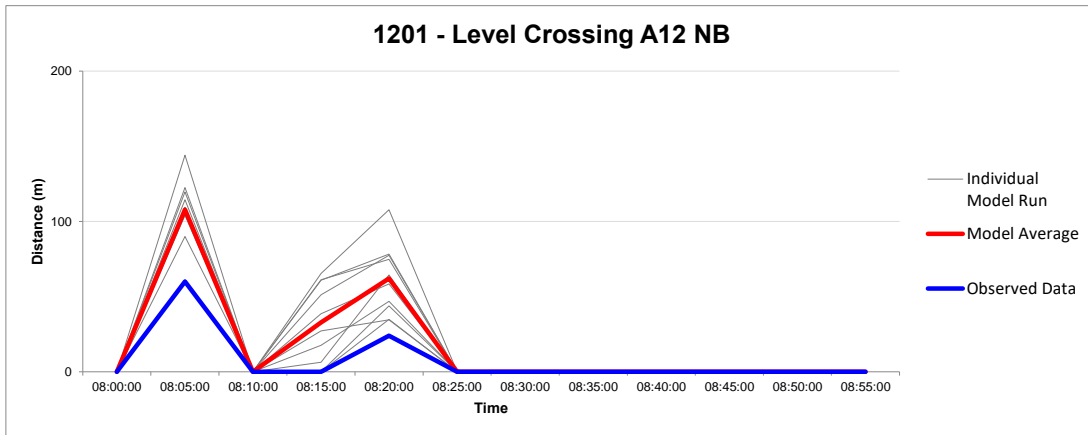



Queue Graphs

Junction Number 13
AM Peak

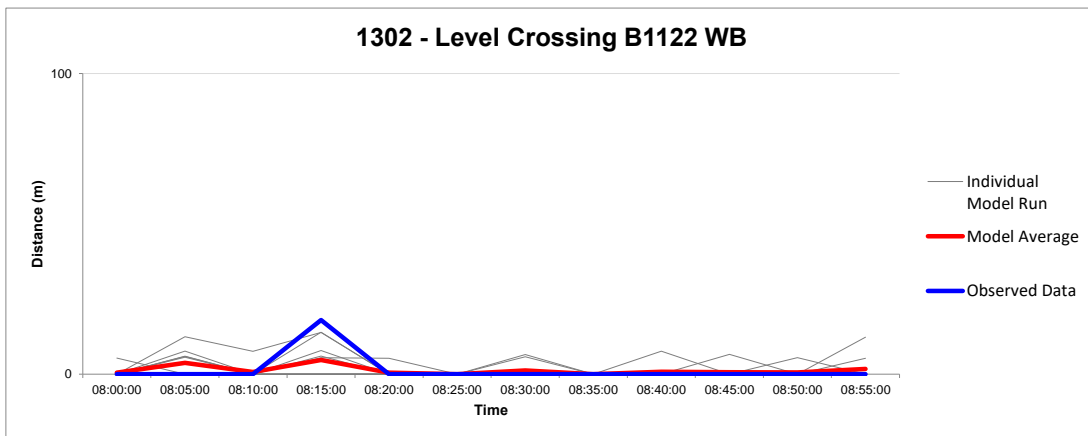
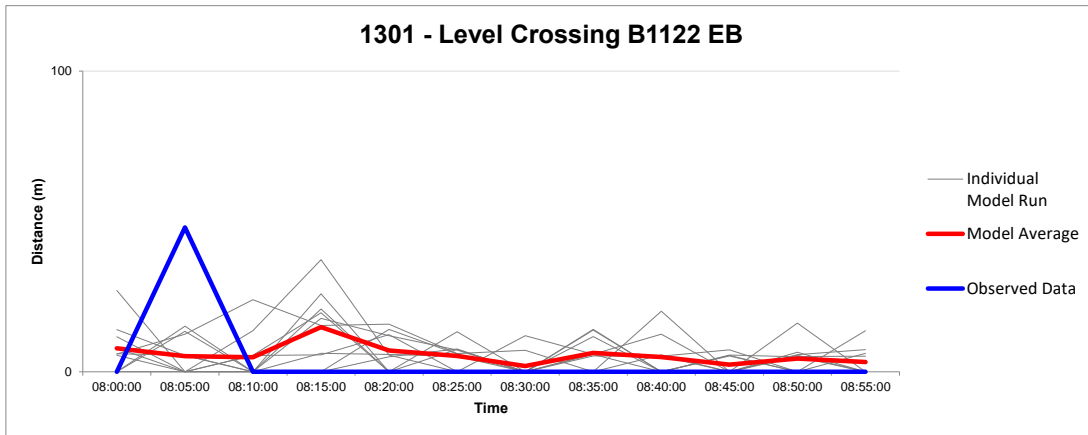



Queue Graphs

Junction Number 3
IP Peak

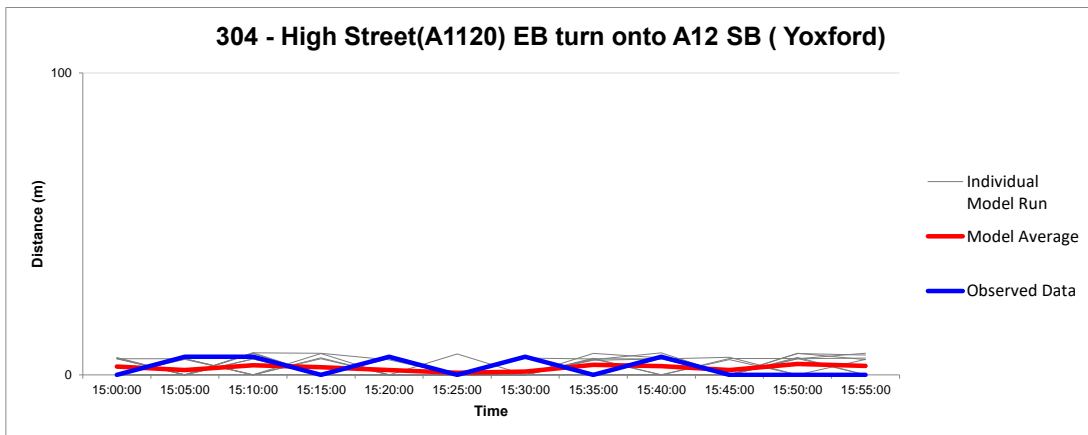
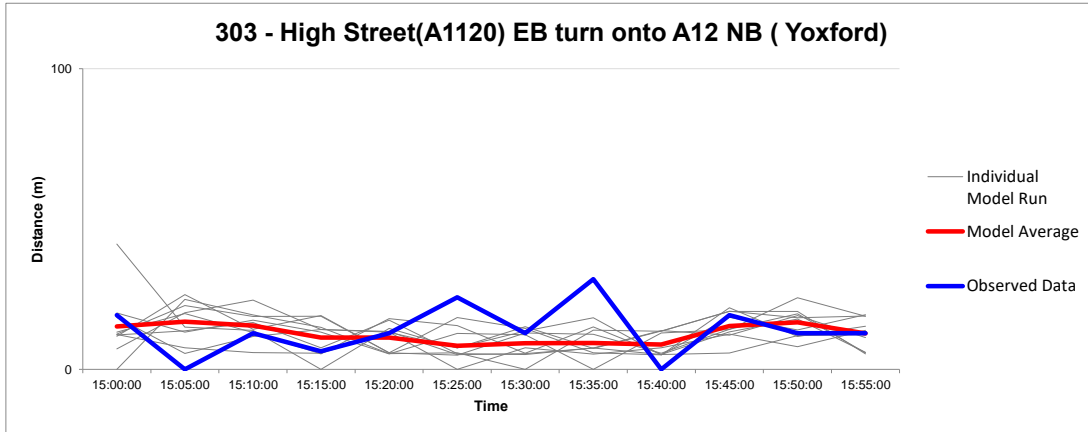
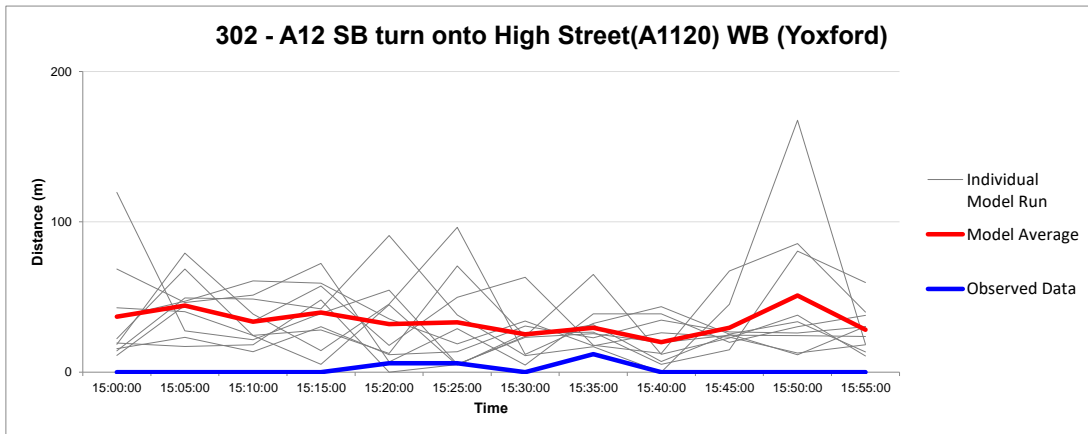
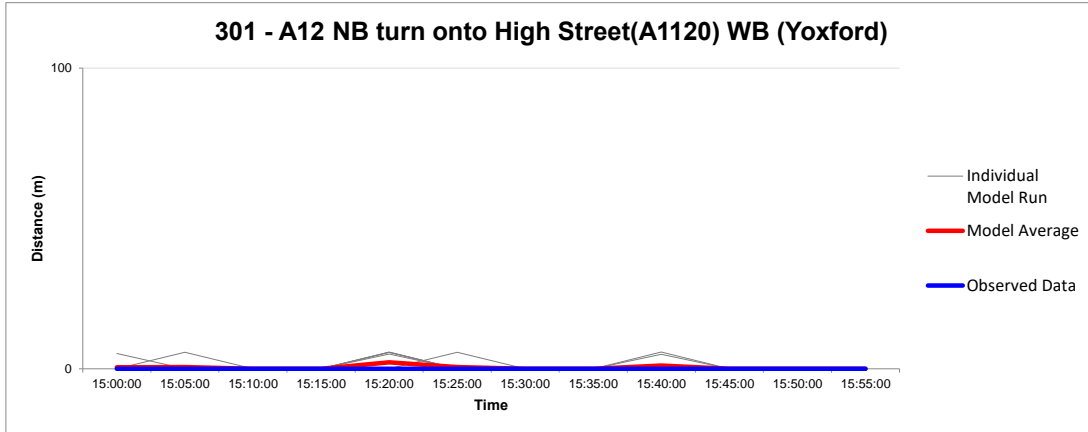



Queue Graphs

Junction Number 4
IP Peak

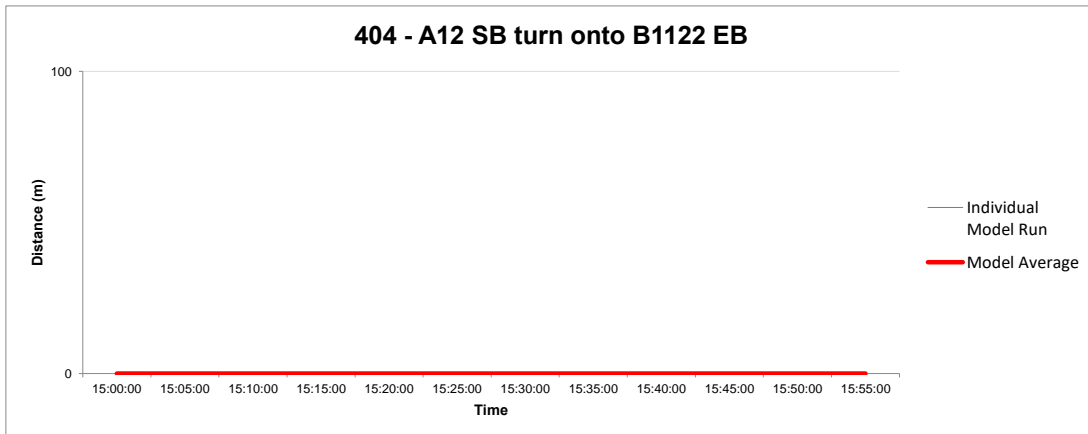
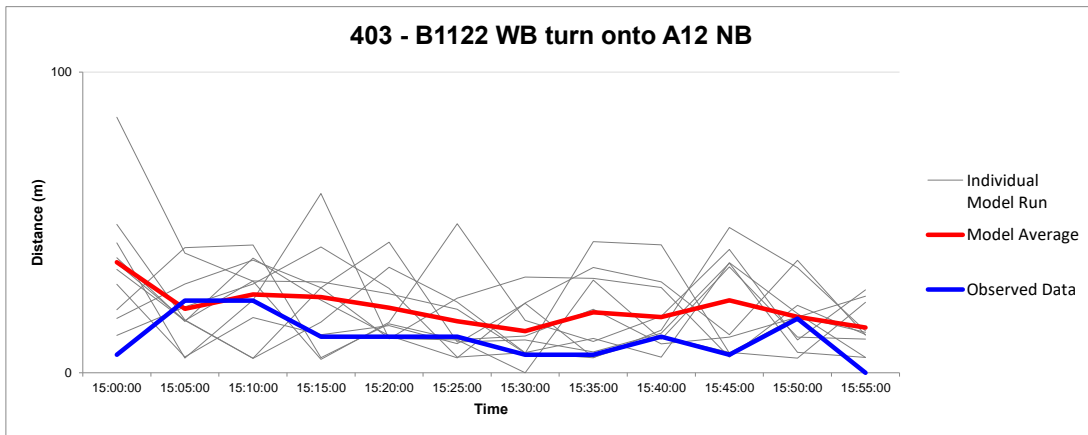
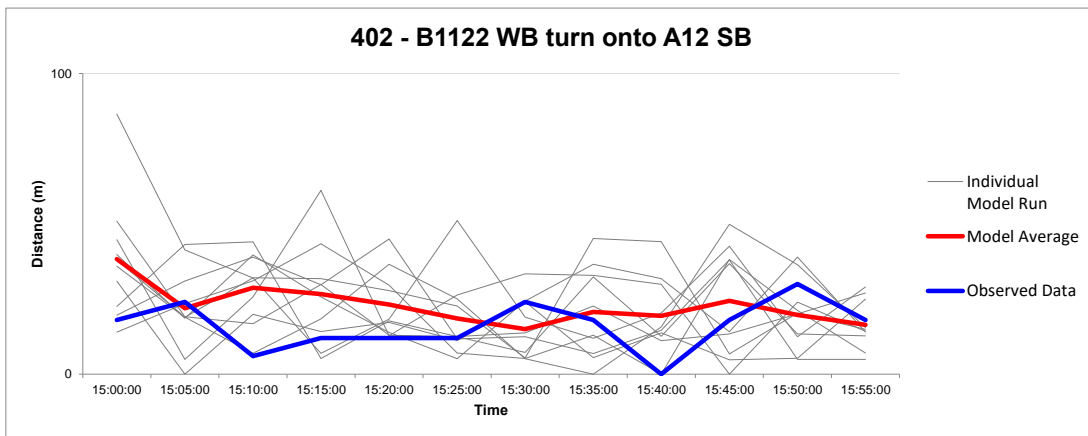
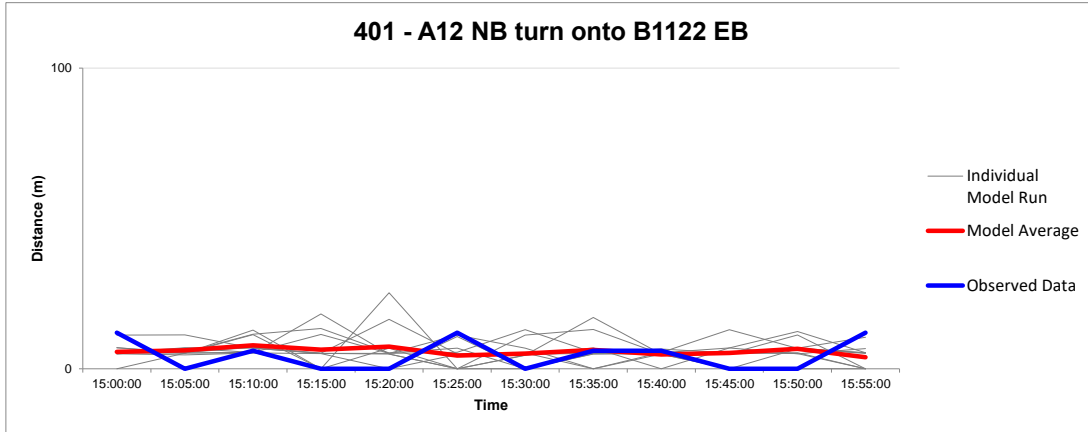



Queue Graphs

Junction Number 5
IP Peak

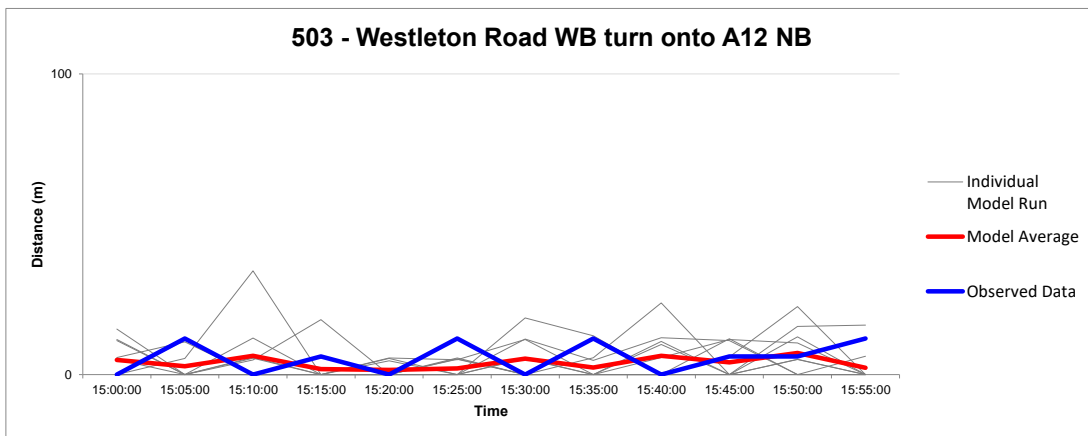
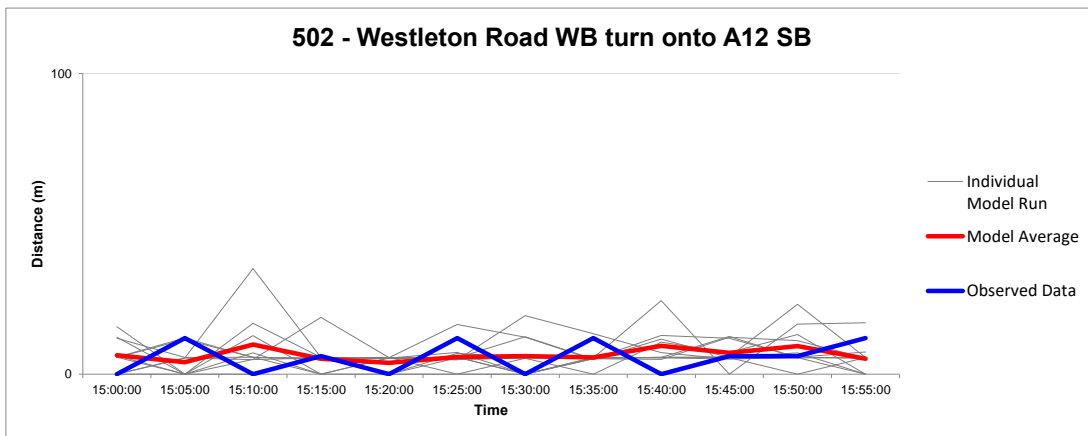
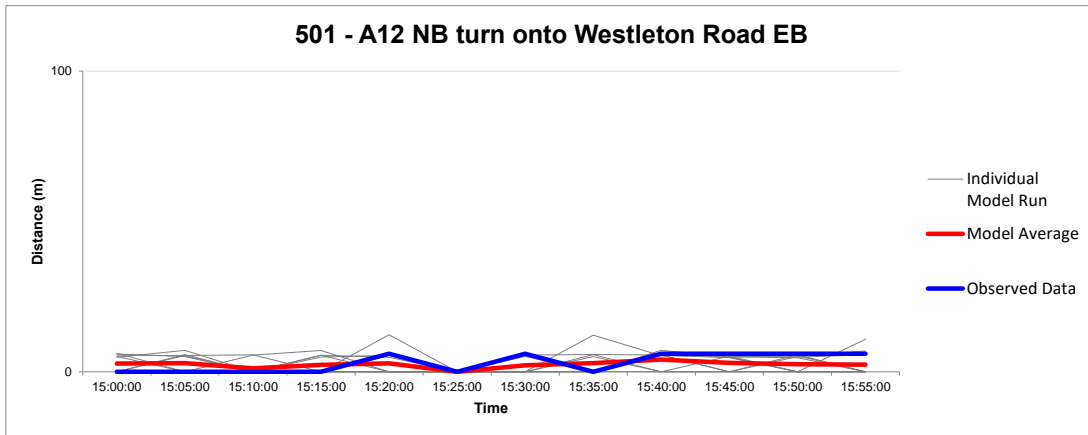



Queue Graphs

Junction Number 6
IP Peak

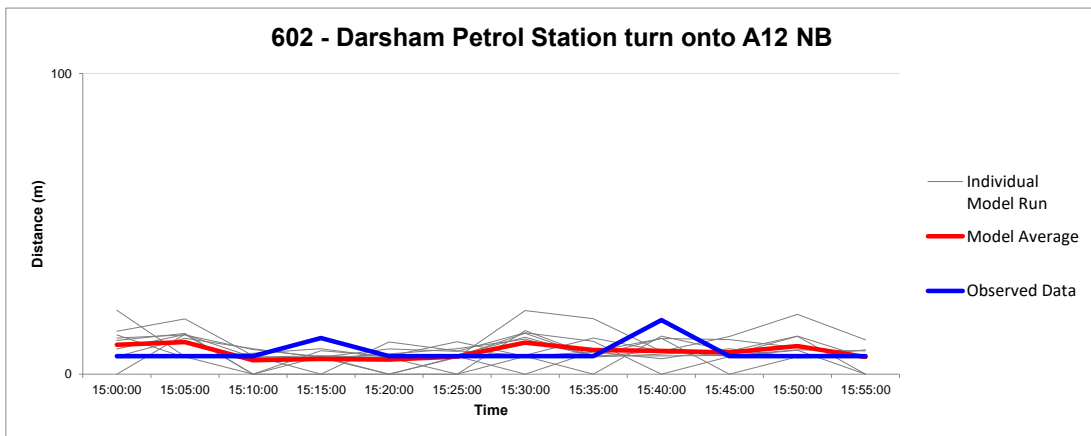
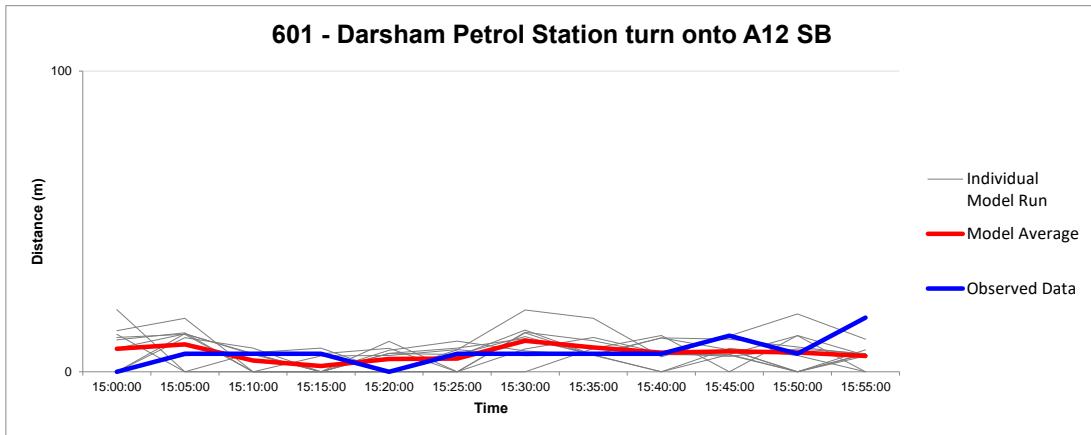



Queue Graphs

Junction Number 7
IP Peak

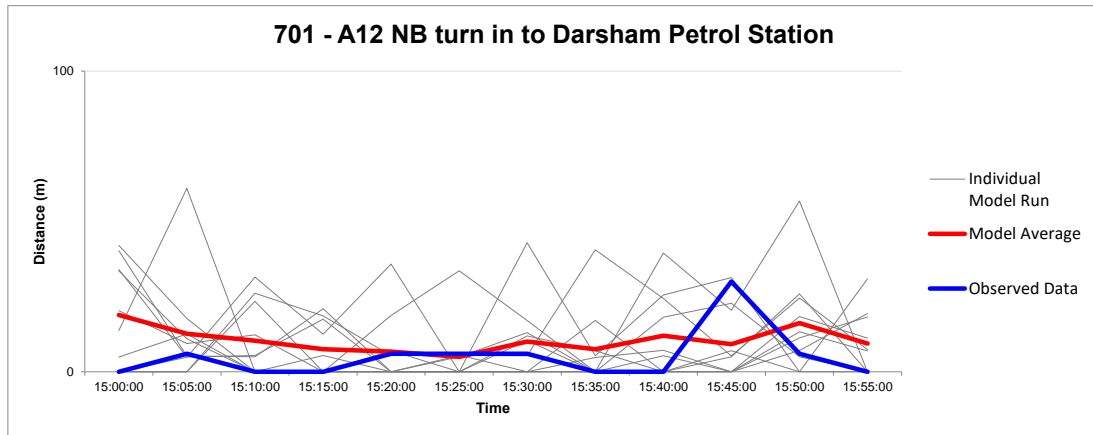



Queue Graphs

Junction Number 8
IP Peak

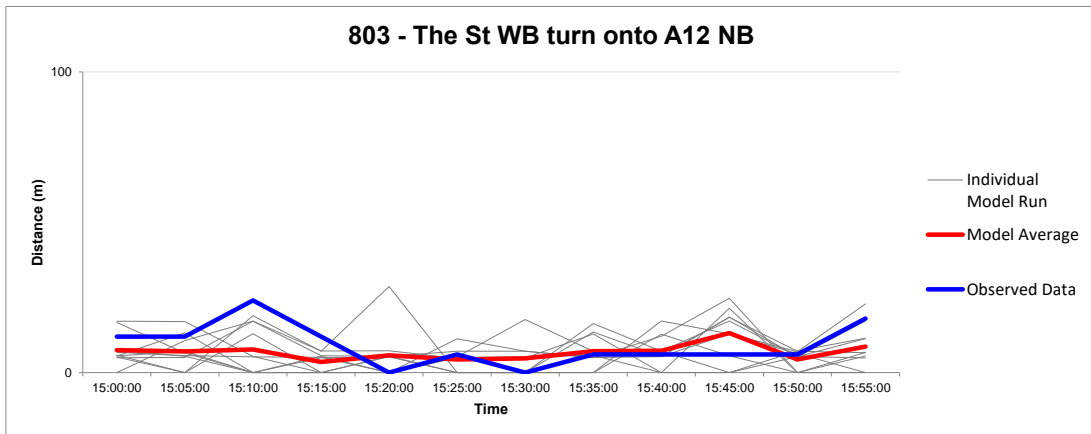
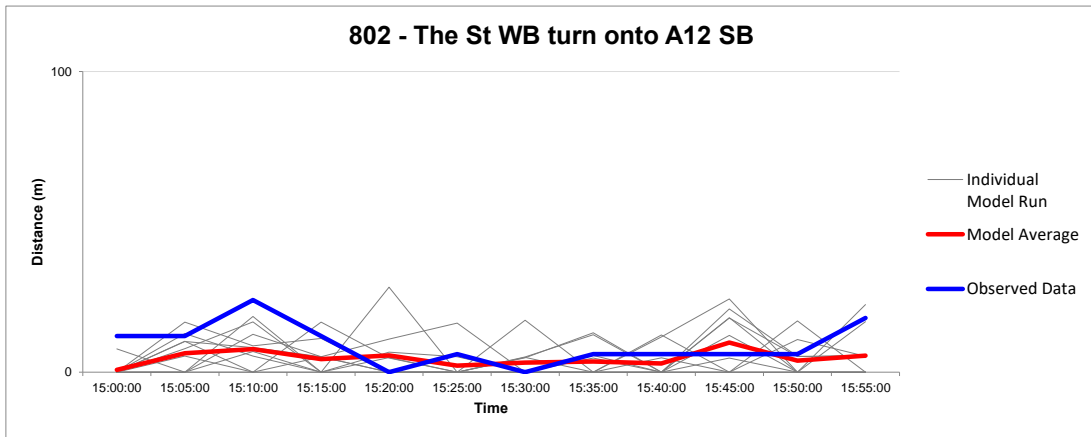
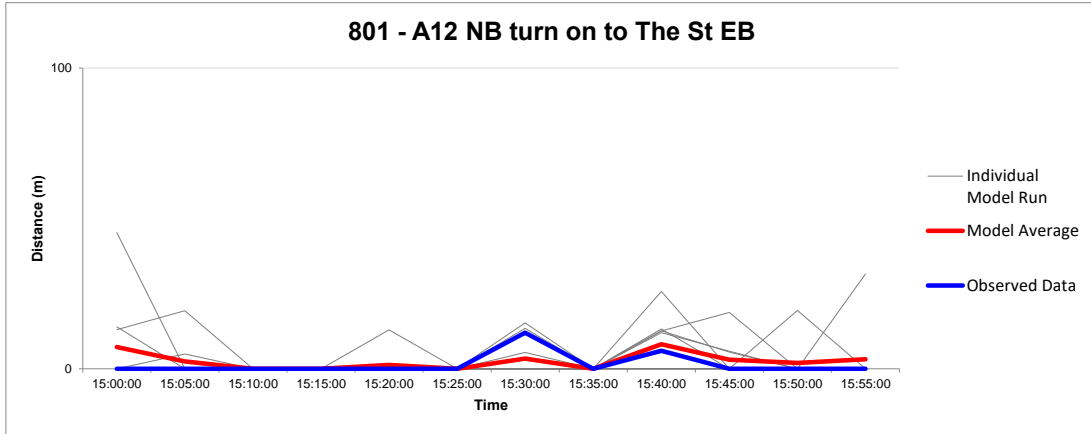



Queue Graphs

Junction Number 9
IP Peak

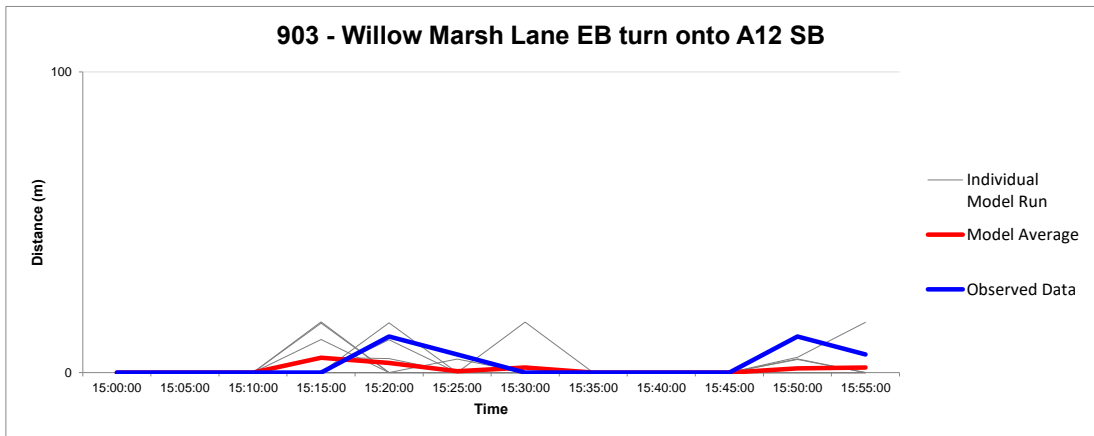
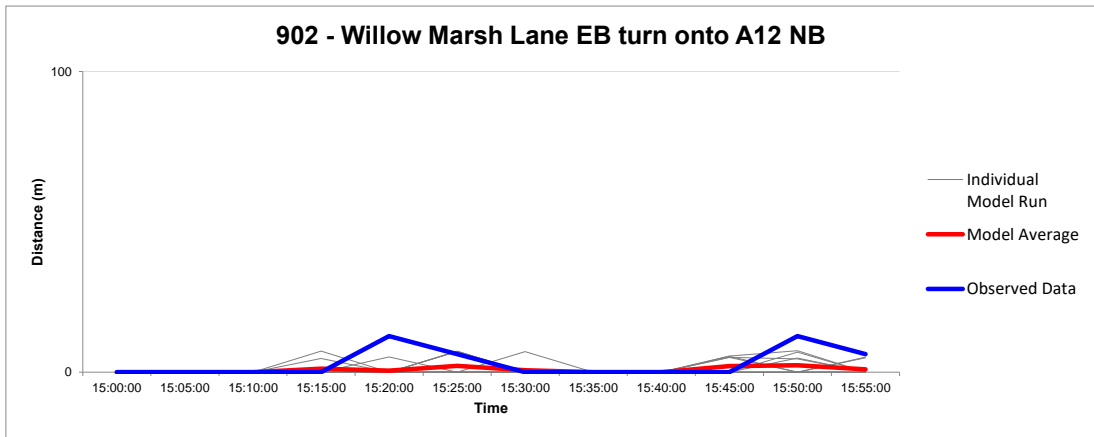
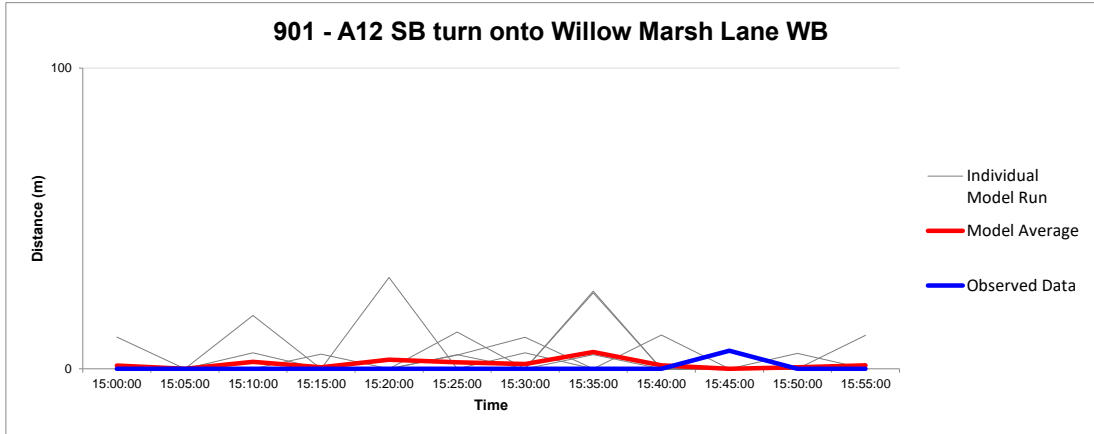



Queue Graphs

Junction Number 10
IP Peak

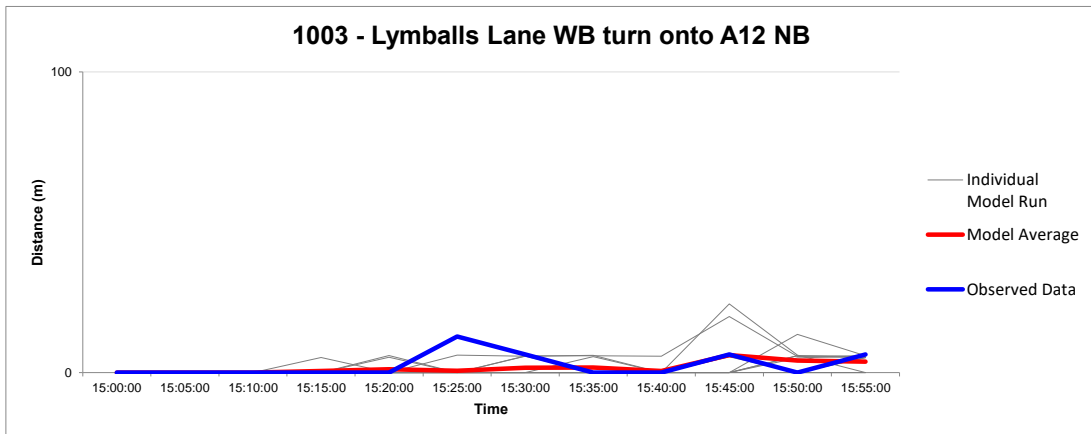
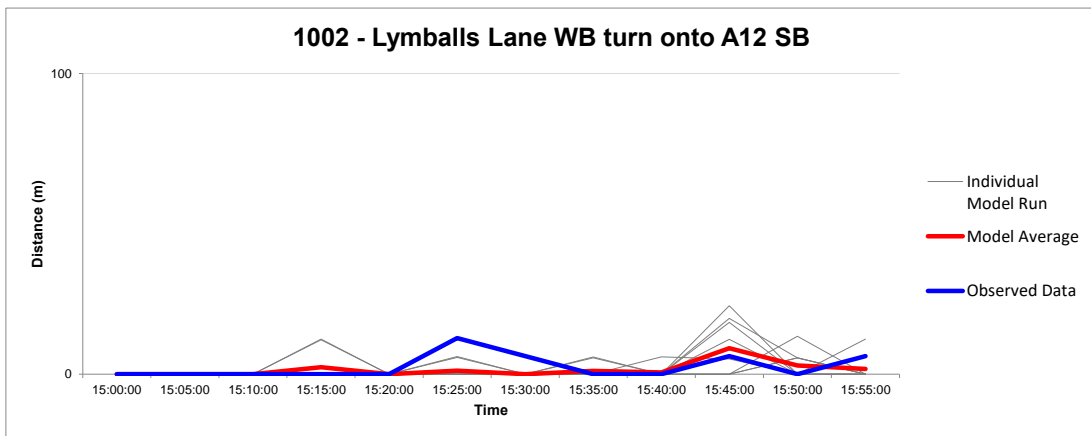
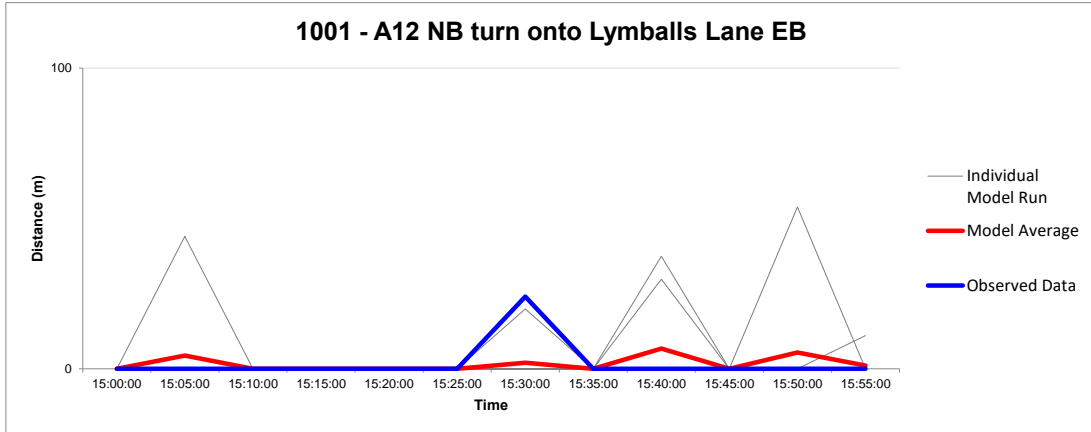



Queue Graphs

Junction Number 11
IP Peak

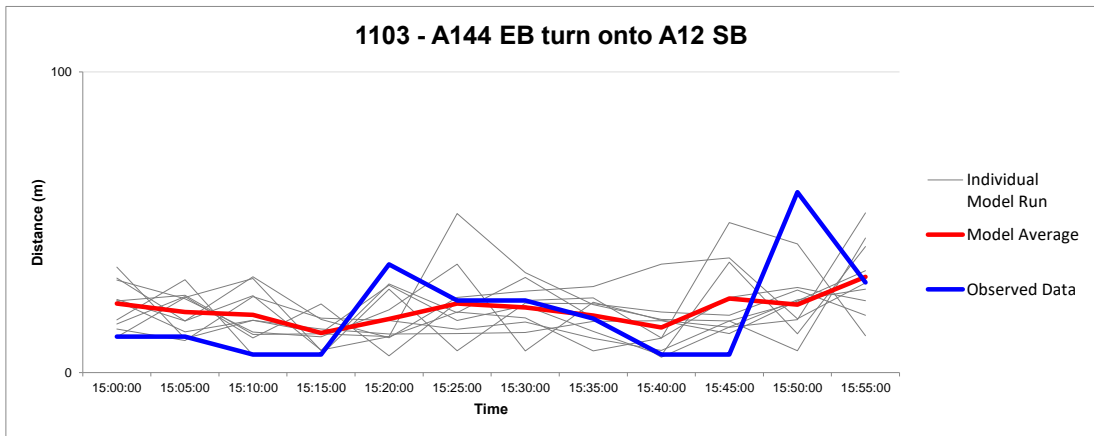
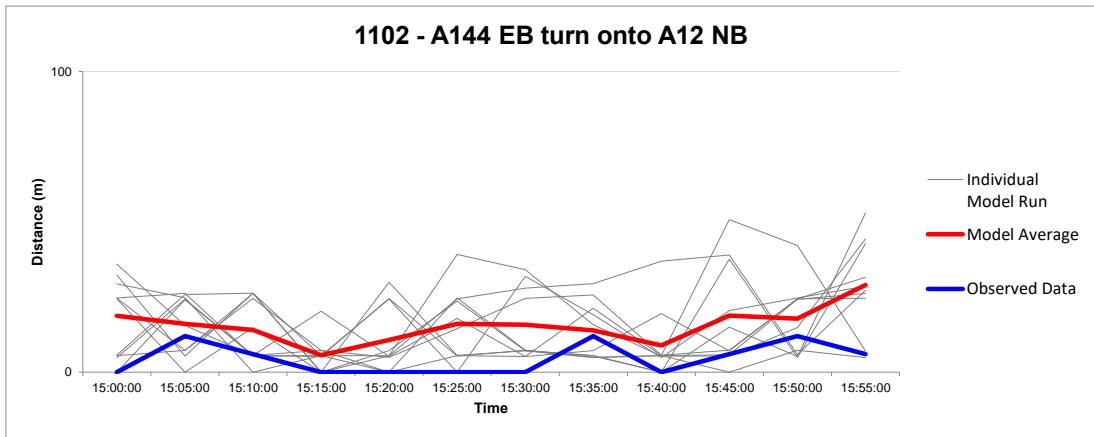
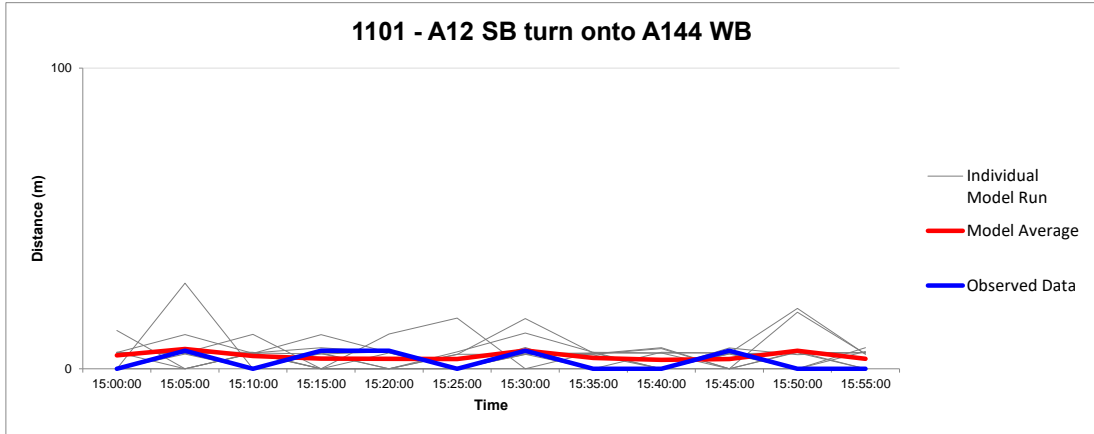



Queue Graphs

Junction Number 12
IP Peak

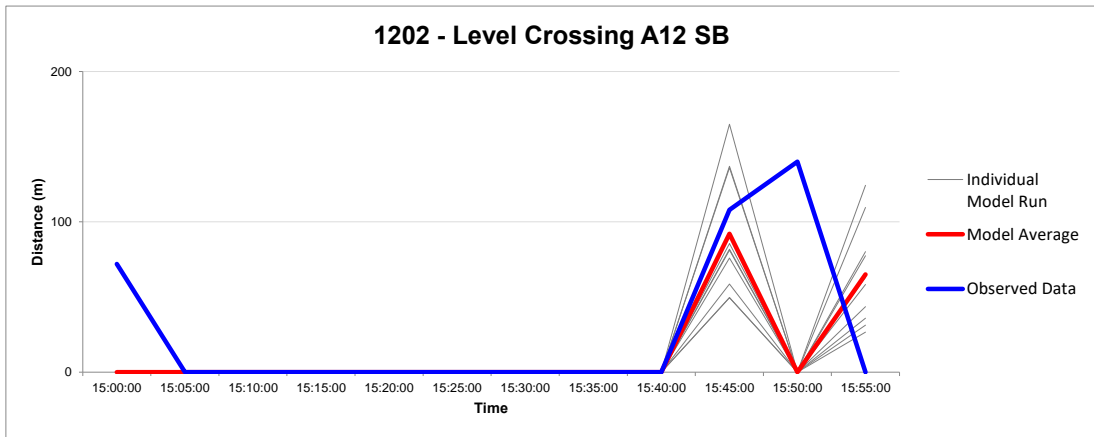
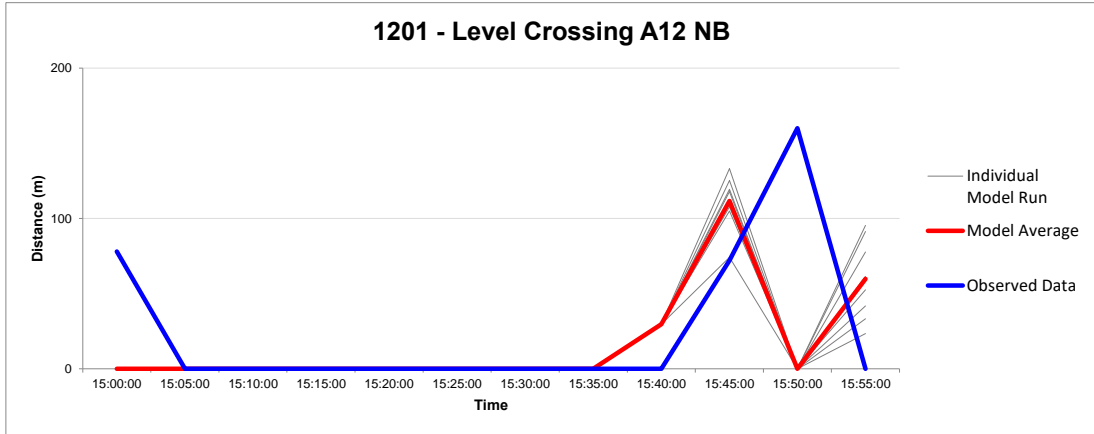



Queue Graphs

Junction Number 13
IP Peak

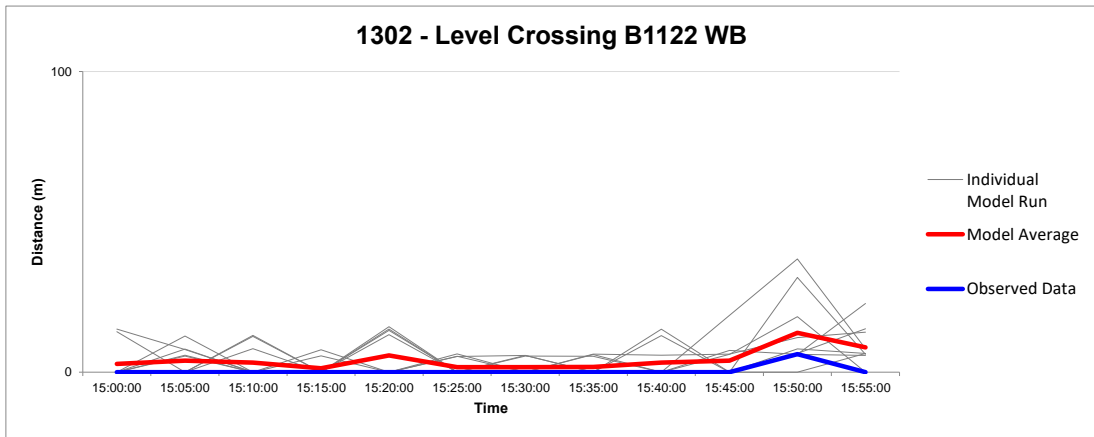
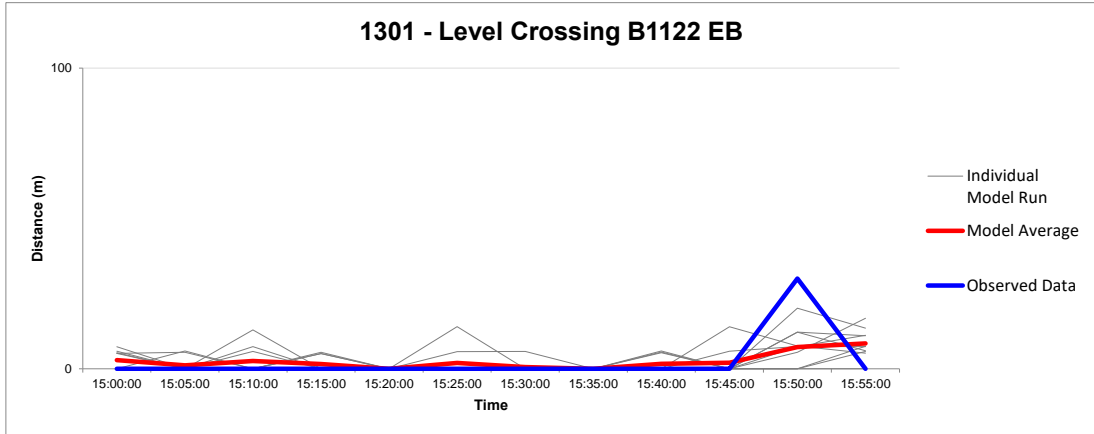



Queue Graphs

Junction Number 3
PM Peak

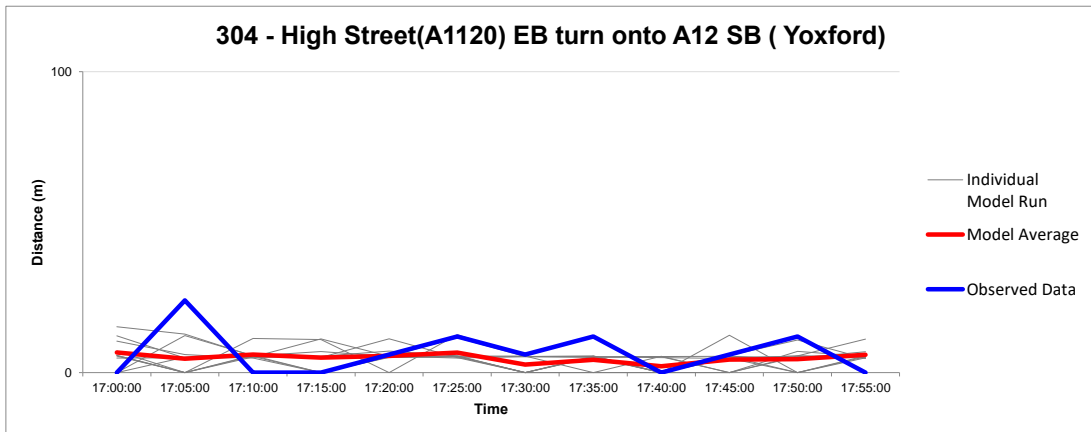
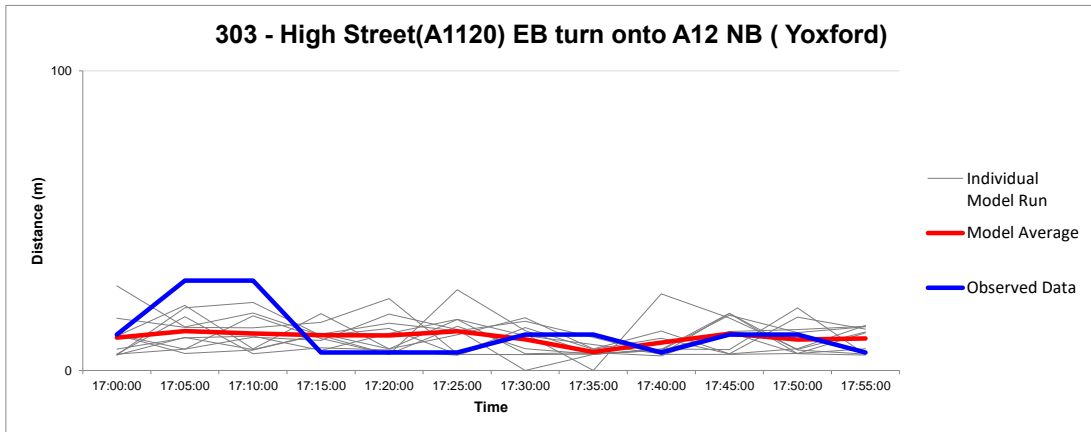
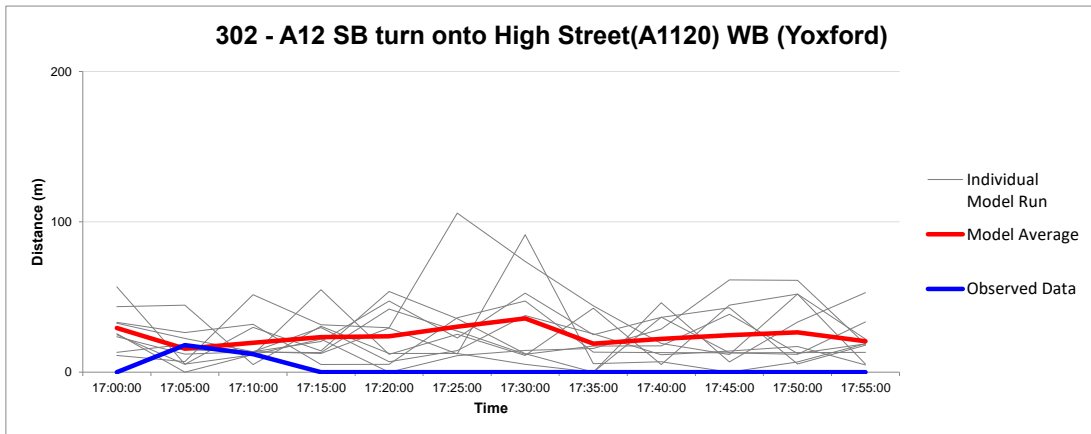
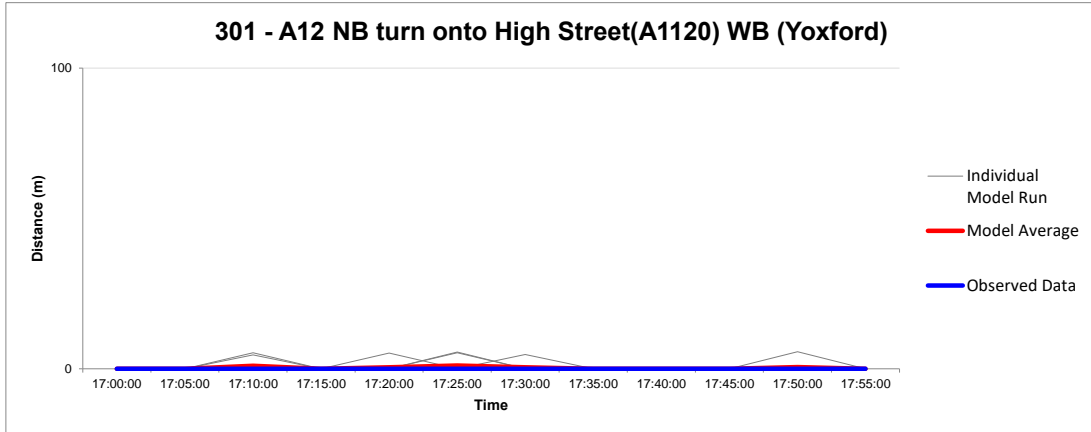



Queue Graphs

Junction Number 4
PM Peak

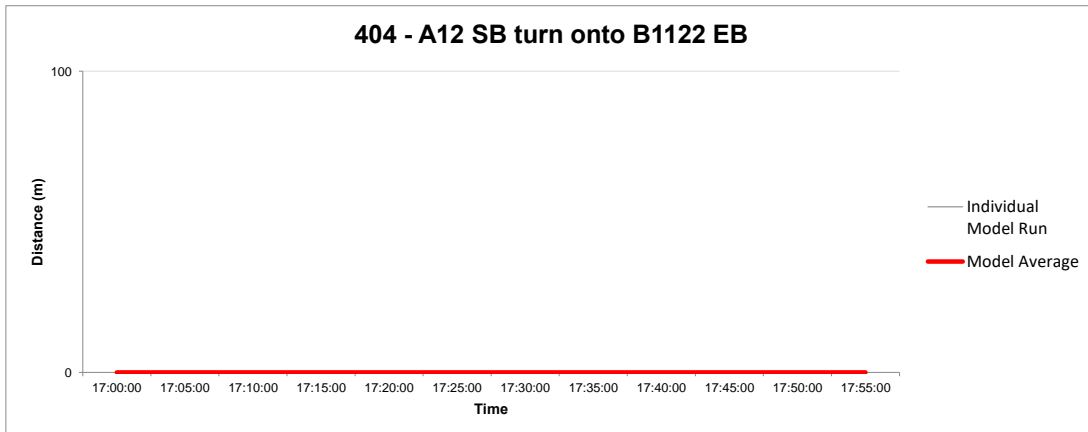
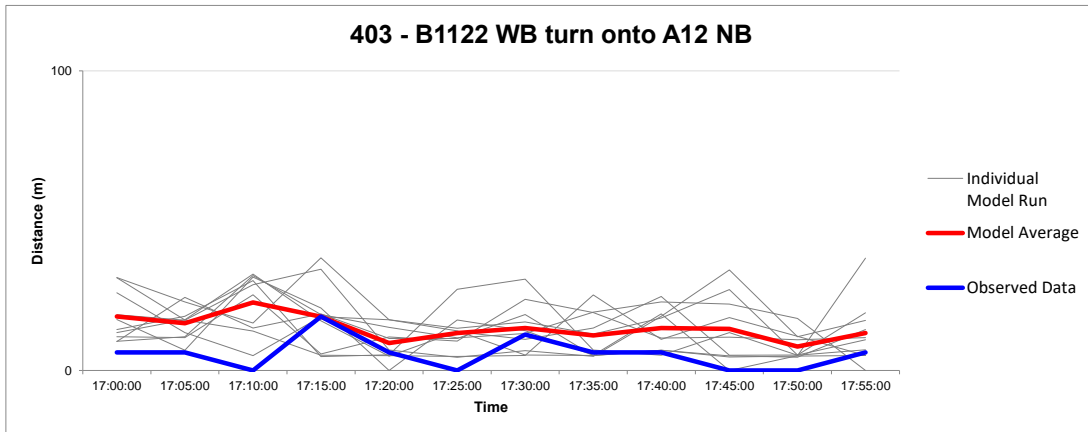
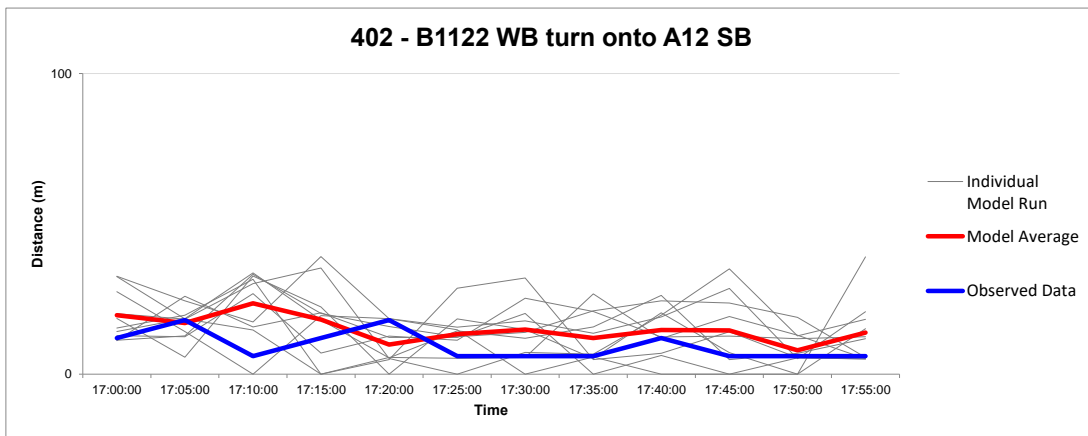
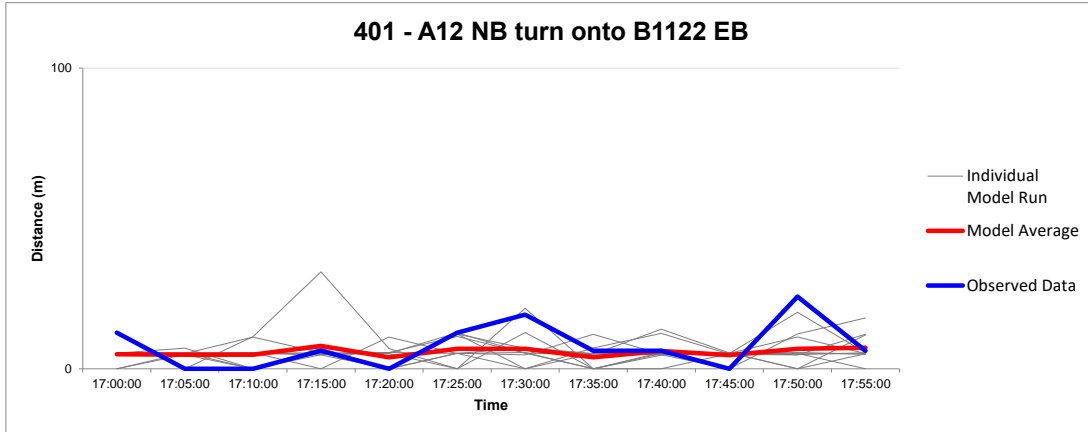



Queue Graphs

Junction Number 5
PM Peak

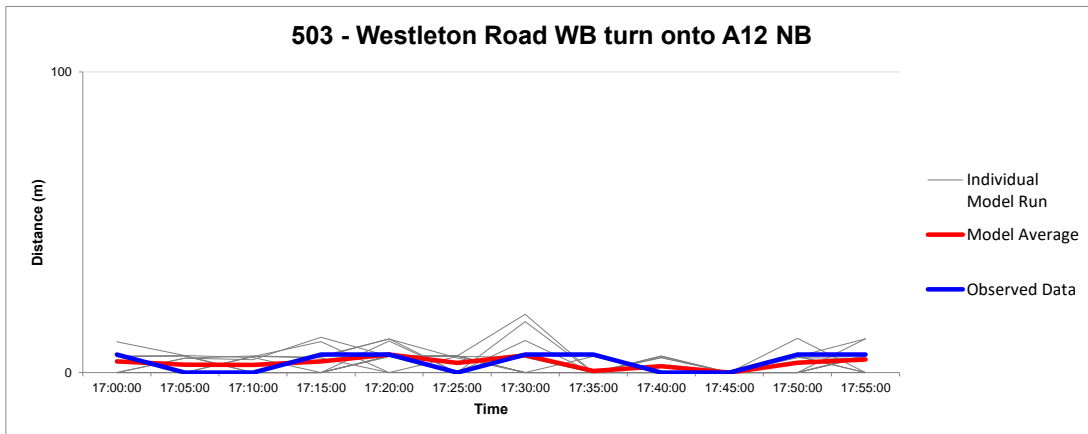
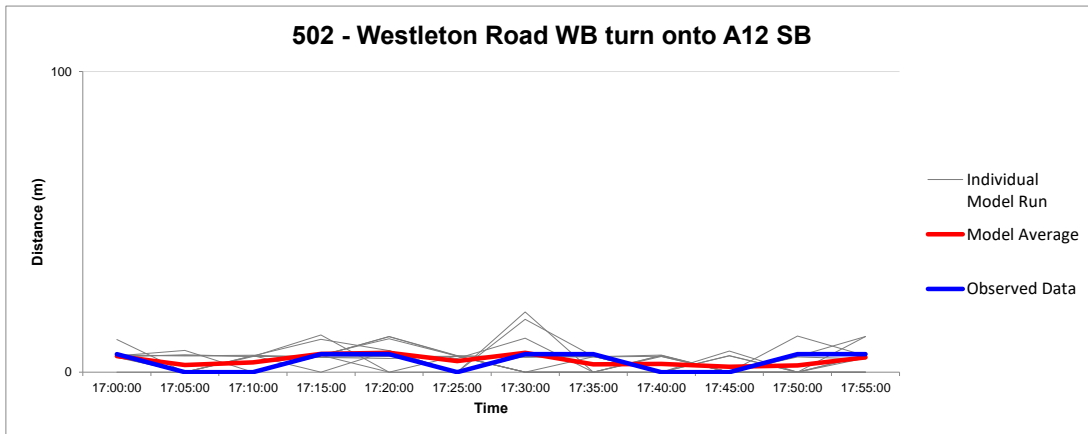
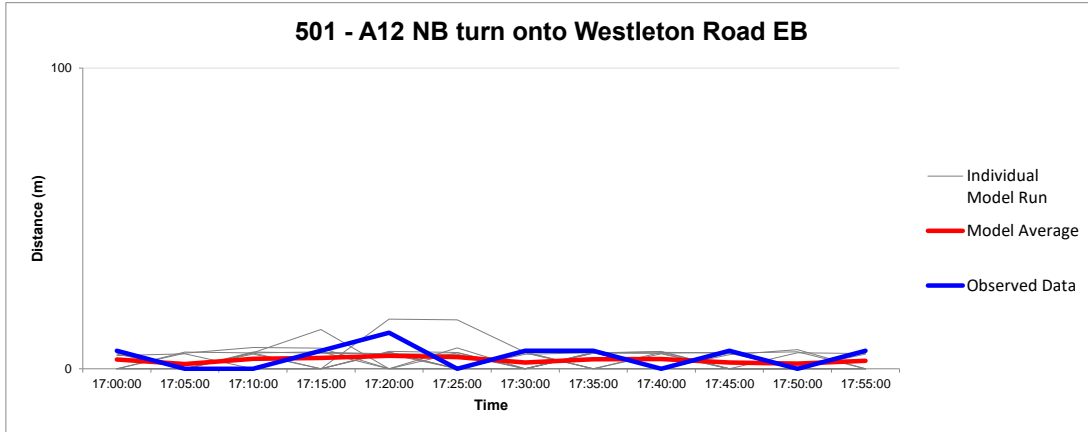



Queue Graphs

Junction Number 6
PM Peak

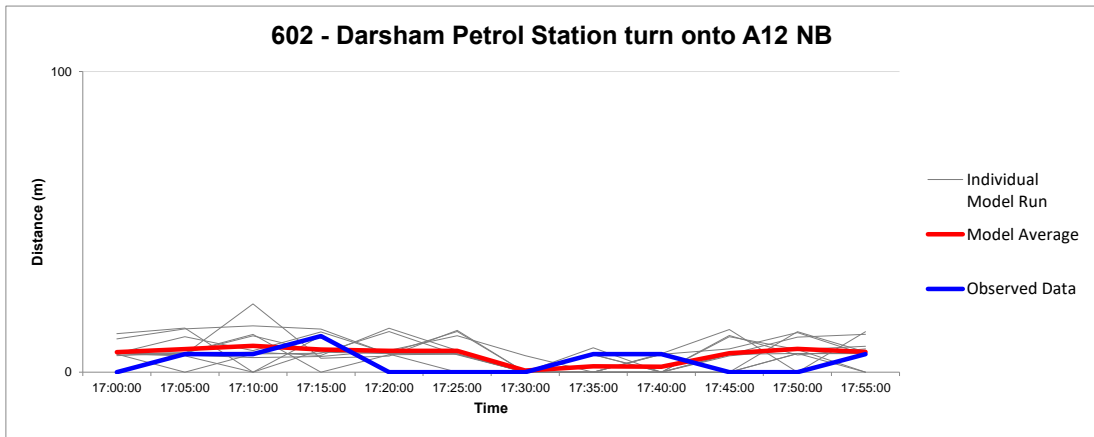
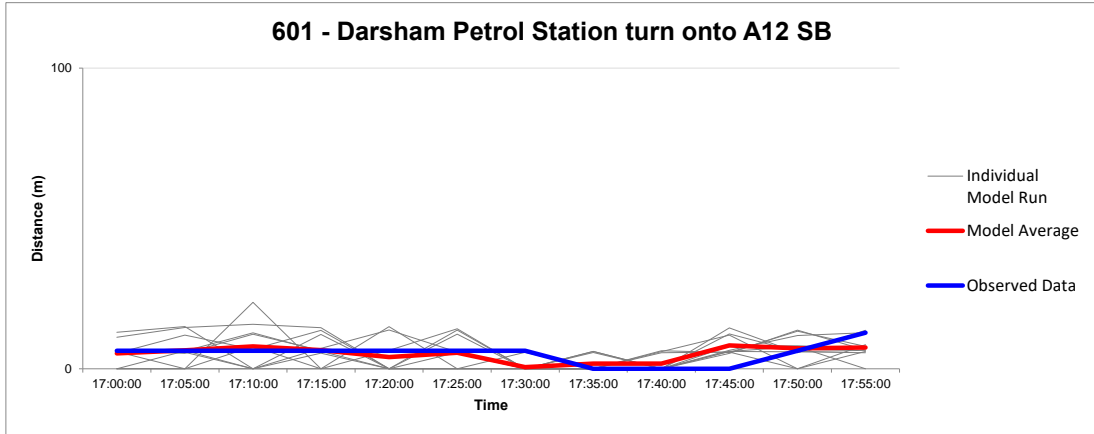



Queue Graphs

Junction Number 7
PM Peak

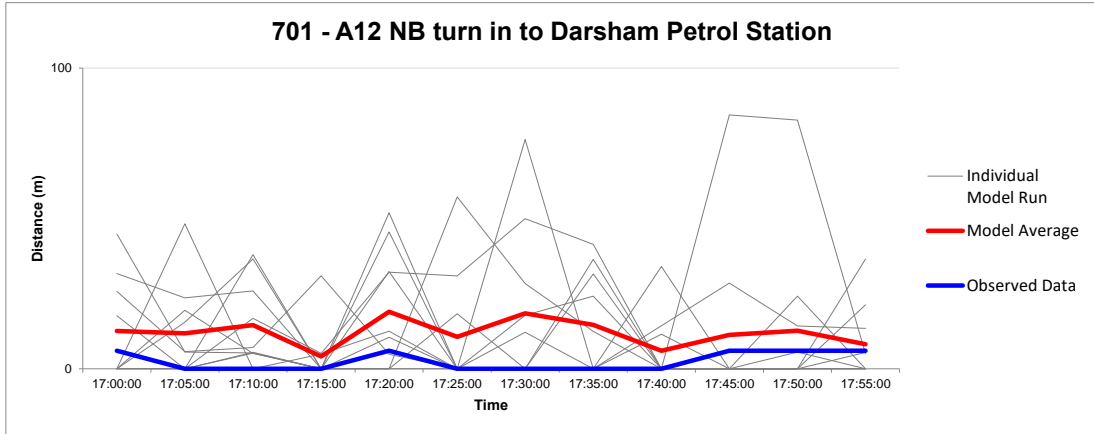



Queue Graphs

Junction Number 8
PM Peak

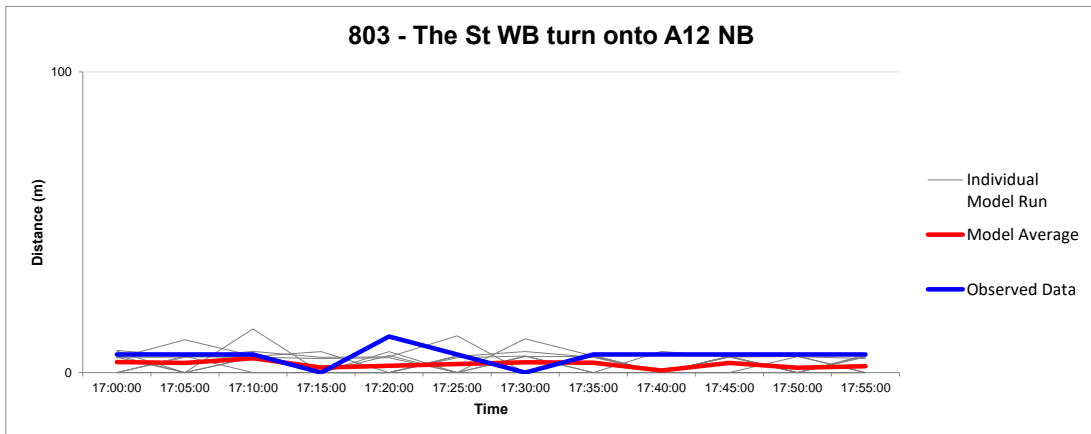
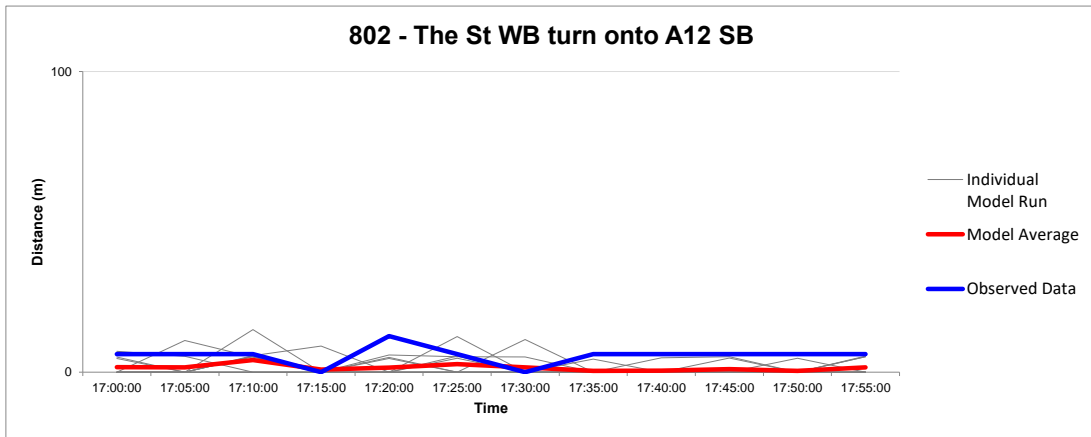
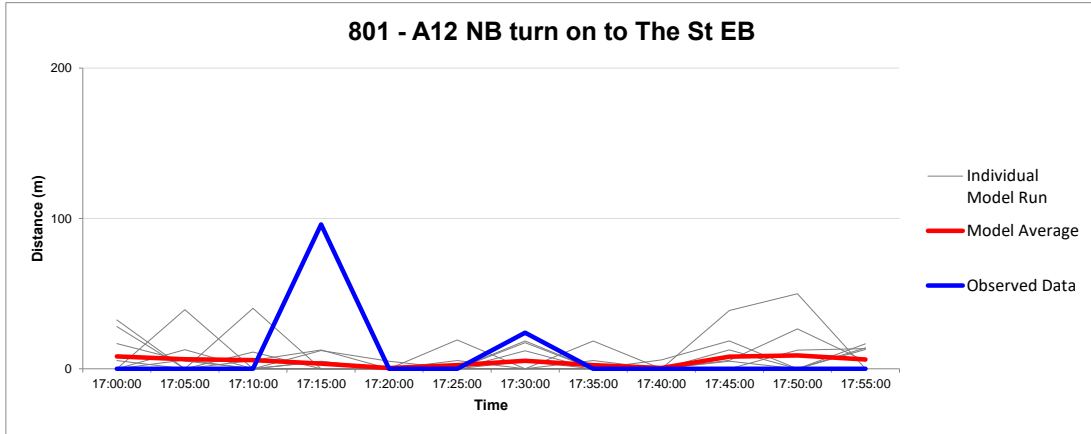



Queue Graphs

Junction Number 9
PM Peak

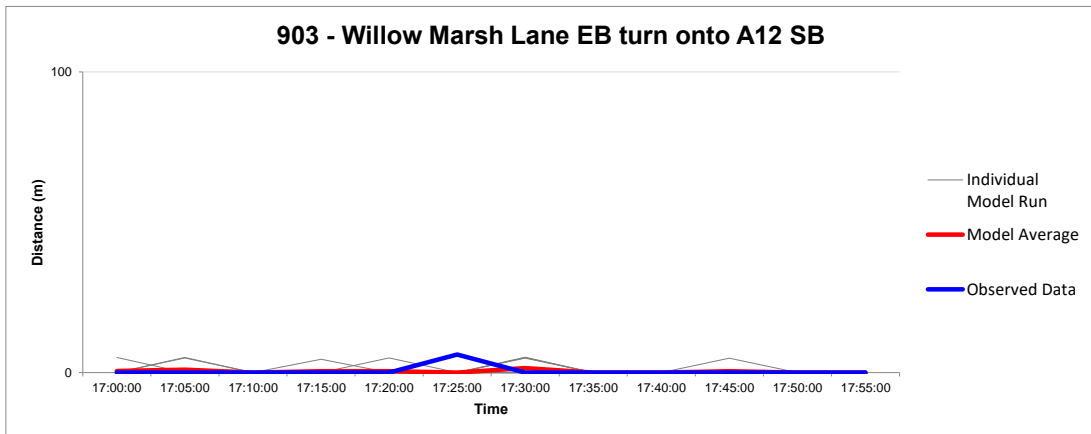
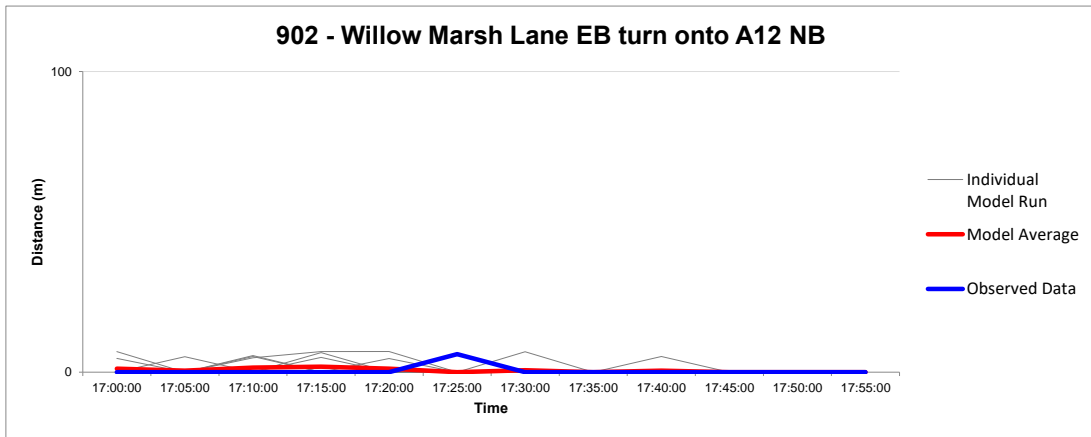
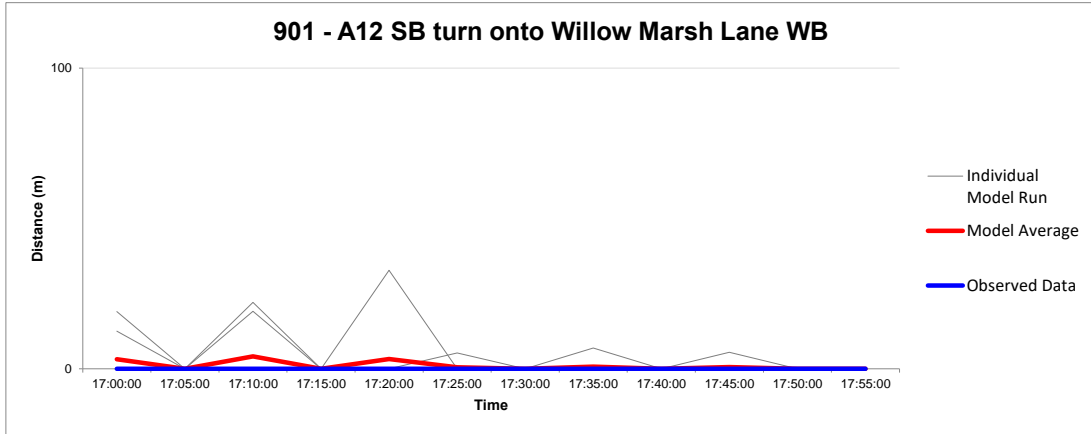



Queue Graphs

Junction Number 10
PM Peak

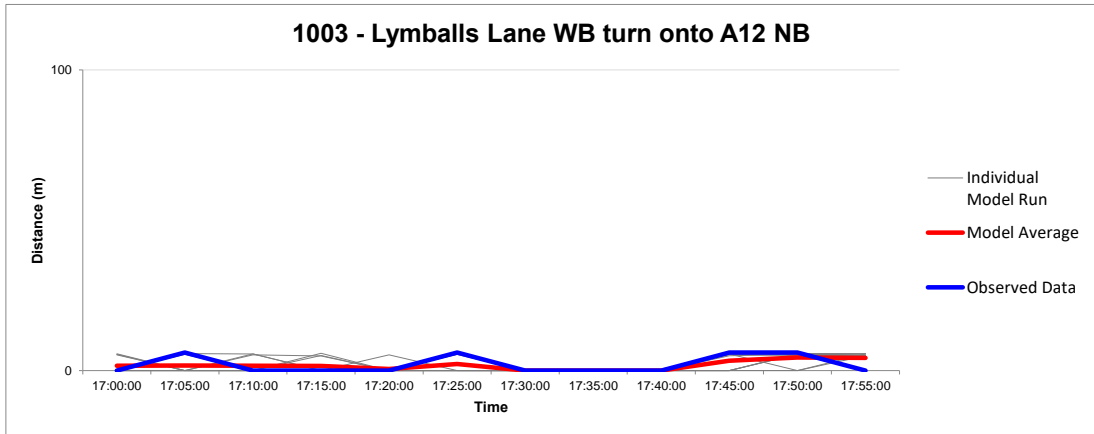
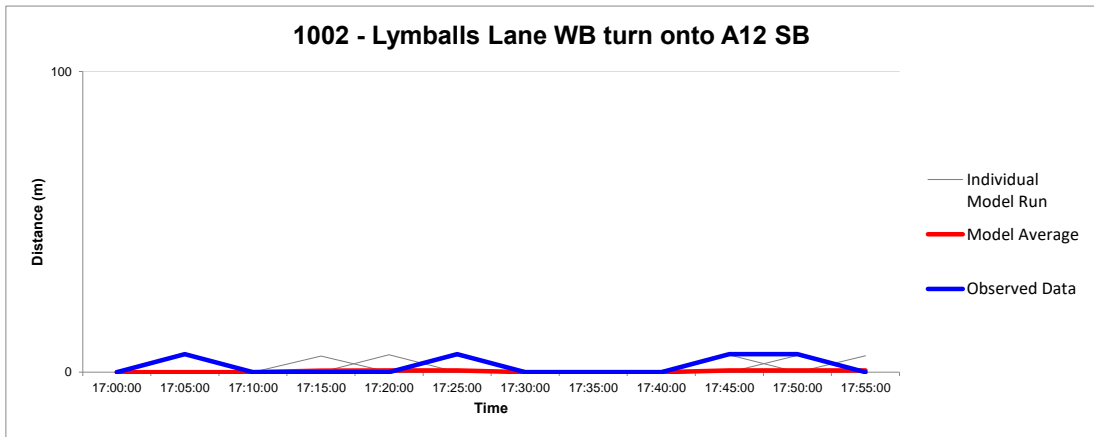
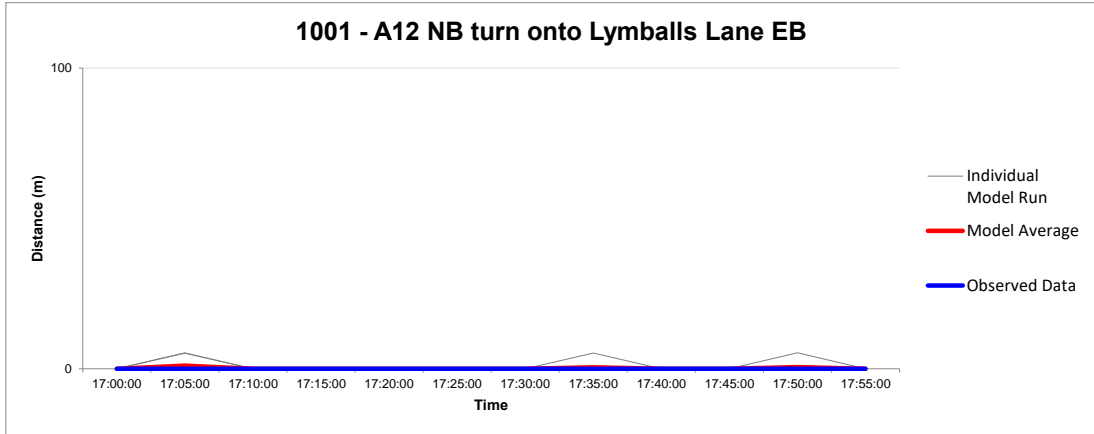



Queue Graphs

Junction Number 11
PM Peak

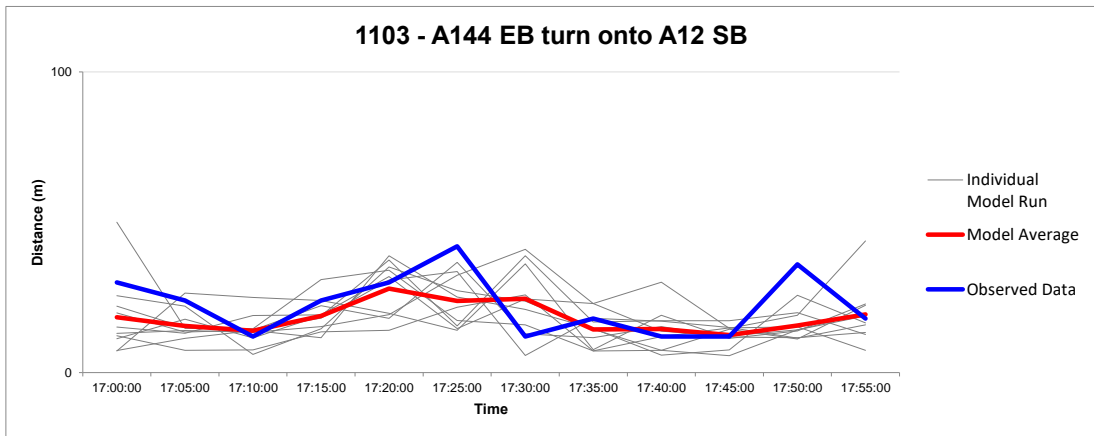
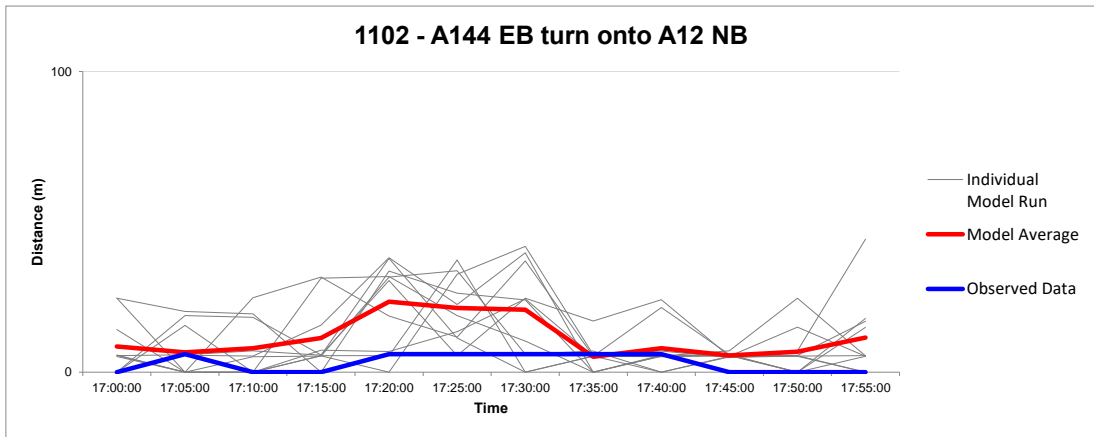
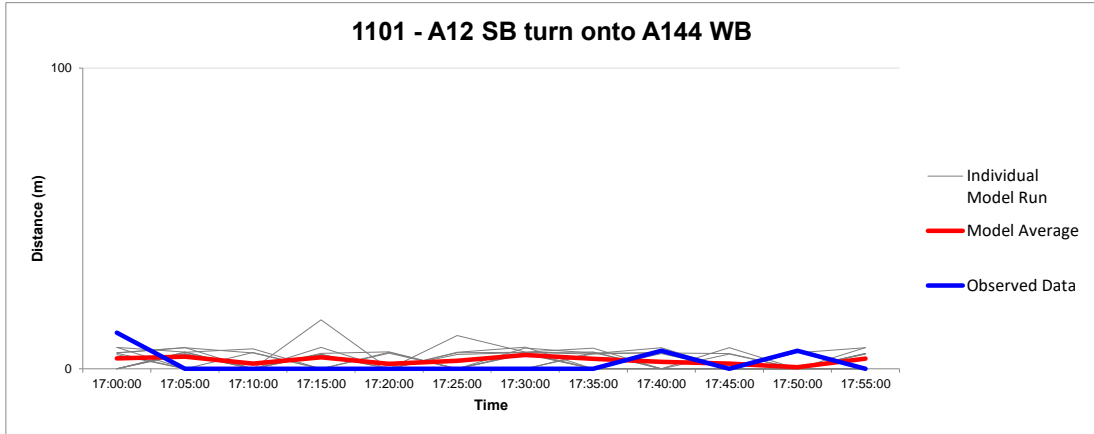



Queue Graphs

Junction Number 12
PM Peak

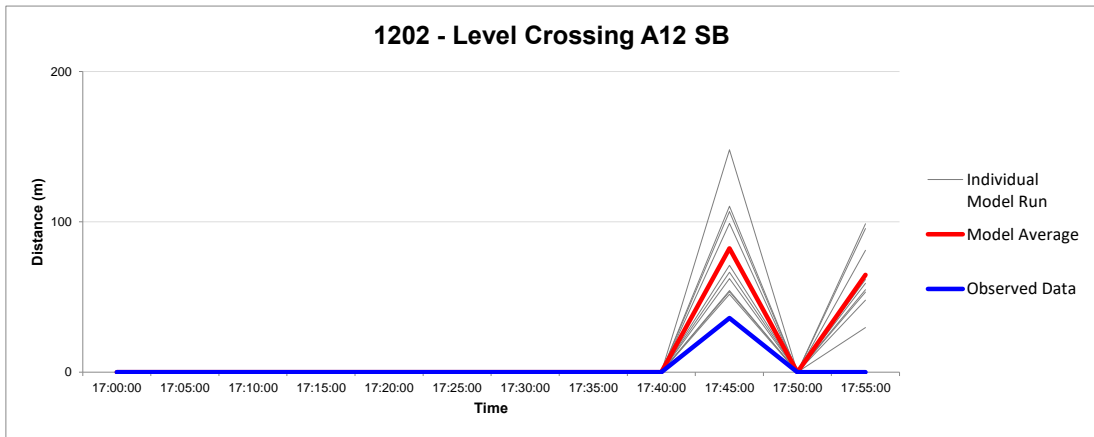
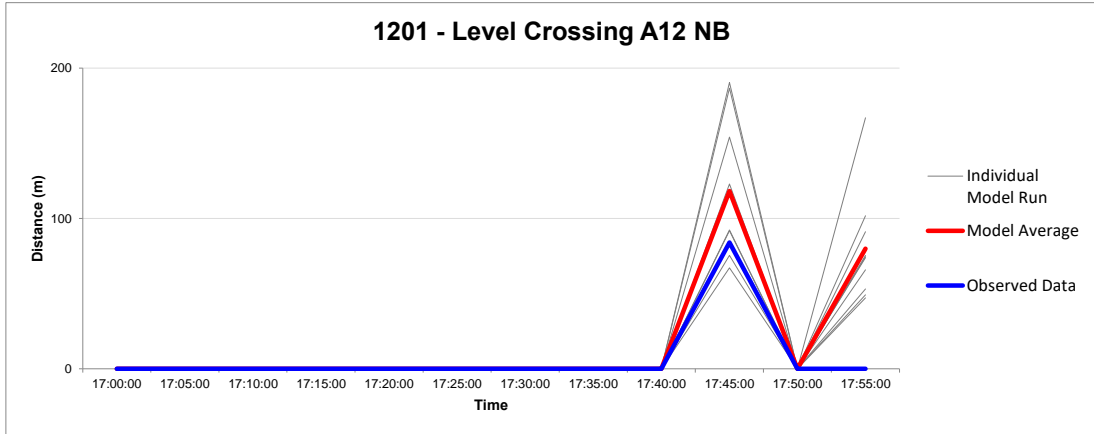



Queue Graphs

Junction Number 13
PM Peak

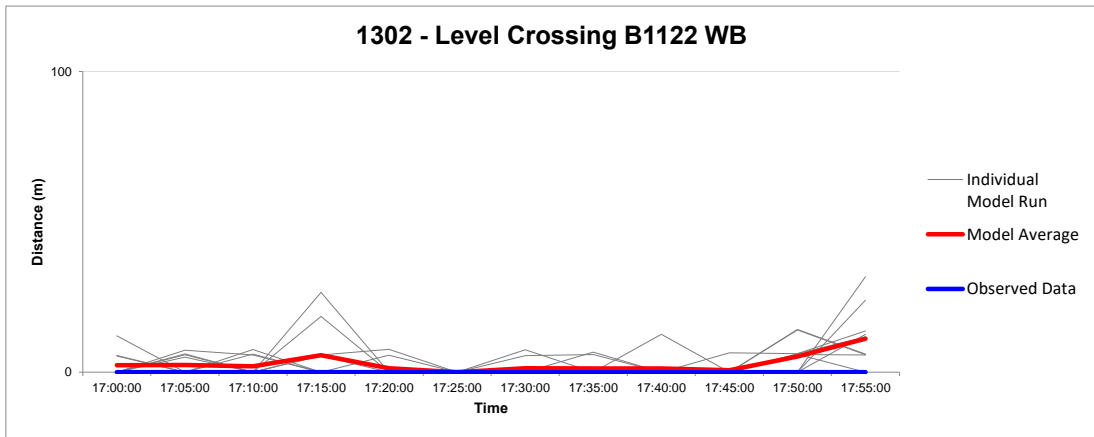
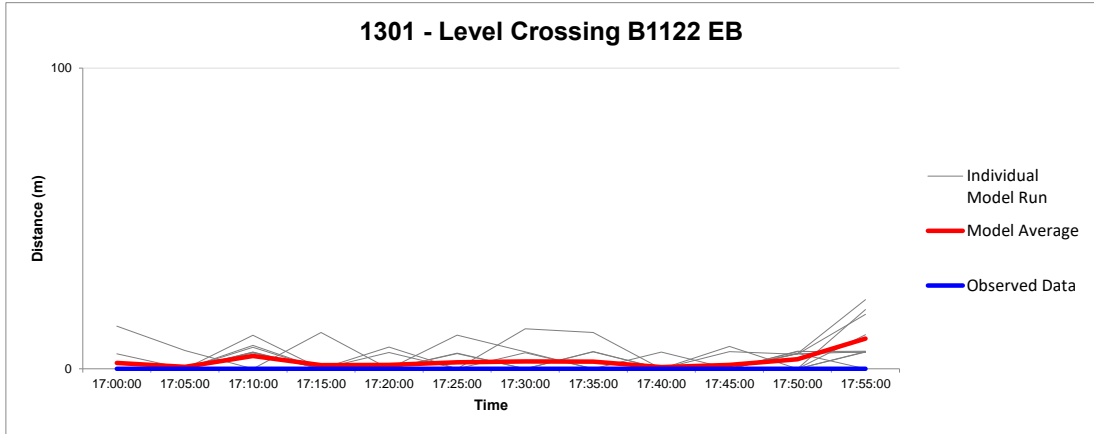



Journey Times
Validation Statistics

AM Peak

Route:	Segment	Graph Group	Observed		Modelled			% Diff	Diff	Conf?	15%	60s	WebTAG	Distance (m)
			Average	95% Conf	Average	95% Conf	Var Chk							
1 - Section 1 NB	Partial - A	1	14		14	0	TRUE	2.9%	0	FALSE	TRUE	TRUE	TRUE	185
2 - Section 2 NB	Partial - B	1	60		68	0	TRUE	13.3%	8	FALSE	TRUE	TRUE	TRUE	1114
3 - Section 3 NB	Partial - C	1	68		68	0	TRUE	-0.9%	-1	FALSE	TRUE	TRUE	TRUE	1055
4 - Section 4 NB	Partial - D	1	52		54	0	TRUE	2.9%	1	FALSE	TRUE	TRUE	TRUE	1062
5 - Section 1 SB	Partial - E	2	48		54	0	TRUE	14.1%	7	FALSE	TRUE	TRUE	TRUE	1066
6 - Section 2 SB	Partial - F	2	66		71	0	TRUE	8.2%	5	FALSE	TRUE	TRUE	TRUE	1074
7 - Section 3 SB	Partial - G	2	61		68	0	TRUE	11.4%	7	FALSE	TRUE	TRUE	TRUE	1096
8 - Section 4 SB	Partial - H	2	13		16	0	TRUE	24.7%	3	FALSE	FALSE	TRUE	TRUE	190



Journey Time Summary
for Group Number 1

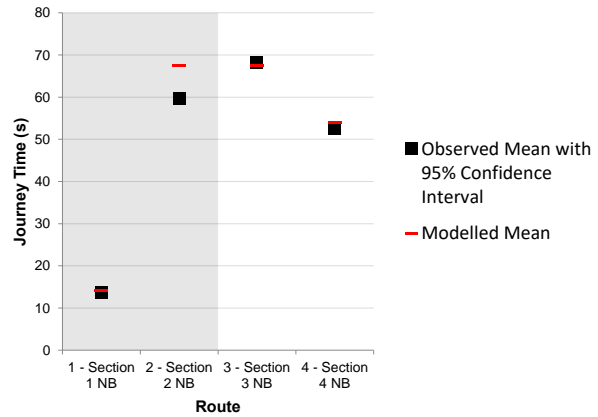

Journey Time Summary by Distance for Group Number 1

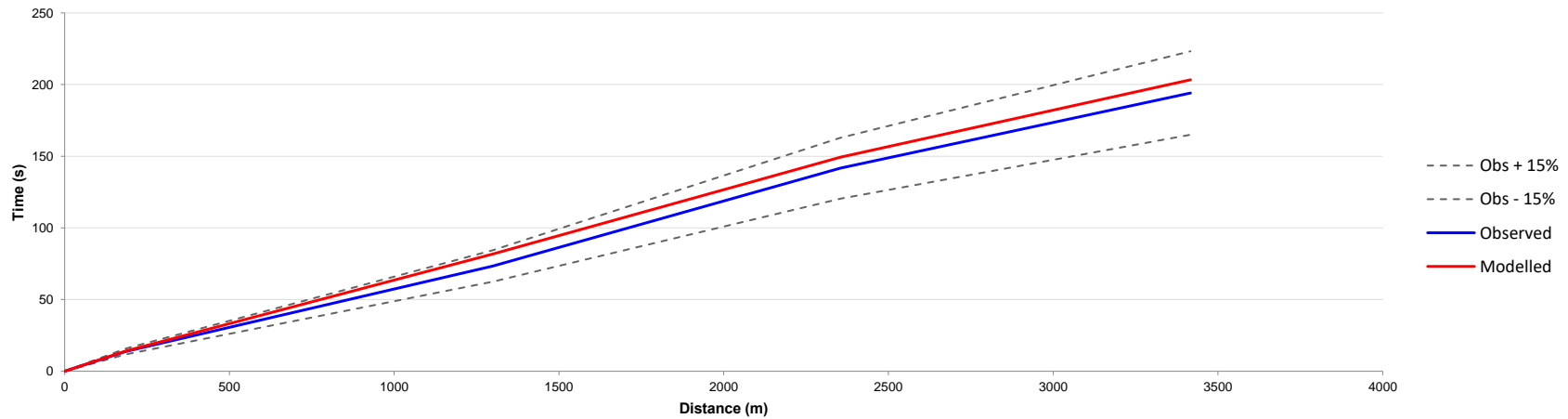



Journey Times Validation Statistics

AM Peak

Journey Time Summary for Group Number 2

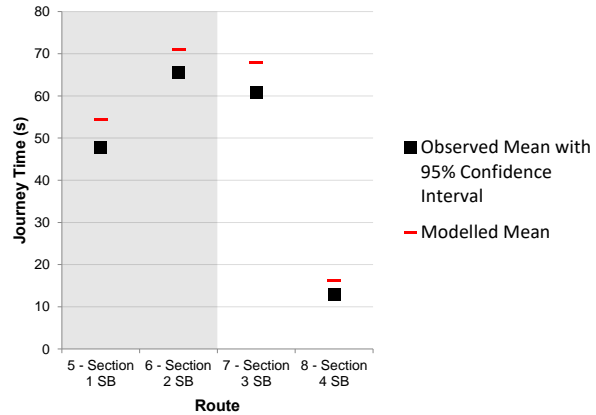

Journey Time Summary by Distance for Group Number 2

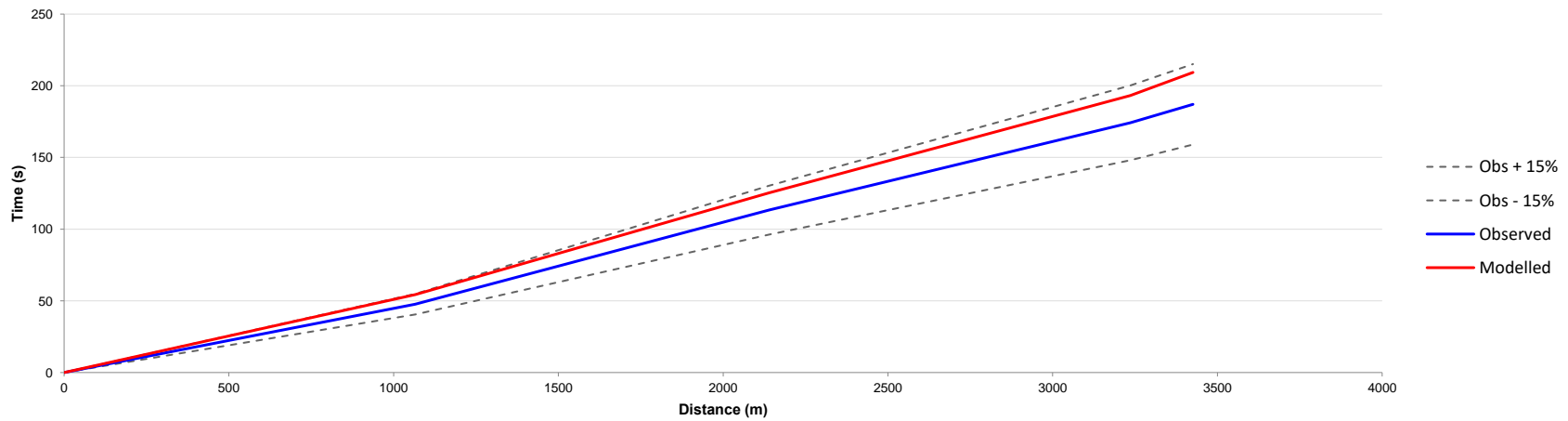



Journey Times
Validation Statistics

IP Peak

Route:	Segment	Graph Group	Observed		Modelled			% Diff	Diff	Conf?	15%	60s	WebTAG	Distance (m)
			Average	95% Conf	Average	95% Conf	Var Chk							
1 - Section 1 NB	Partial - A	1	13		14	0	TRUE	9.4%	1	FALSE	TRUE	TRUE	TRUE	185
2 - Section 2 NB	Partial - B	1	58		68	0	TRUE	16.4%	10	FALSE	FALSE	TRUE	TRUE	1114
3 - Section 3 NB	Partial - C	1	72		67	0	TRUE	-6.7%	-5	FALSE	TRUE	TRUE	TRUE	1055
4 - Section 4 NB	Partial - D	1	60		55	0	TRUE	-9.5%	-6	FALSE	TRUE	TRUE	TRUE	1062
5 - Section 1 SB	Partial - E	2	51		54	0	TRUE	5.7%	3	FALSE	TRUE	TRUE	TRUE	1066
6 - Section 2 SB	Partial - F	2	85		69	0	TRUE	-19.1%	-16	FALSE	FALSE	TRUE	TRUE	1074
7 - Section 3 SB	Partial - G	2	62		67	0	TRUE	8.7%	5	FALSE	TRUE	TRUE	TRUE	1096
8 - Section 4 SB	Partial - H	2	23		18	0	TRUE	-24.8%	-6	FALSE	FALSE	TRUE	TRUE	190



**Journey Time Summary
for Group Number 1**

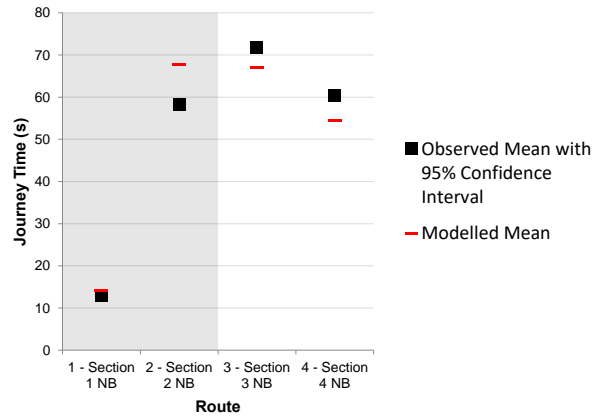

Journey Time Summary by Distance for Group Number 1

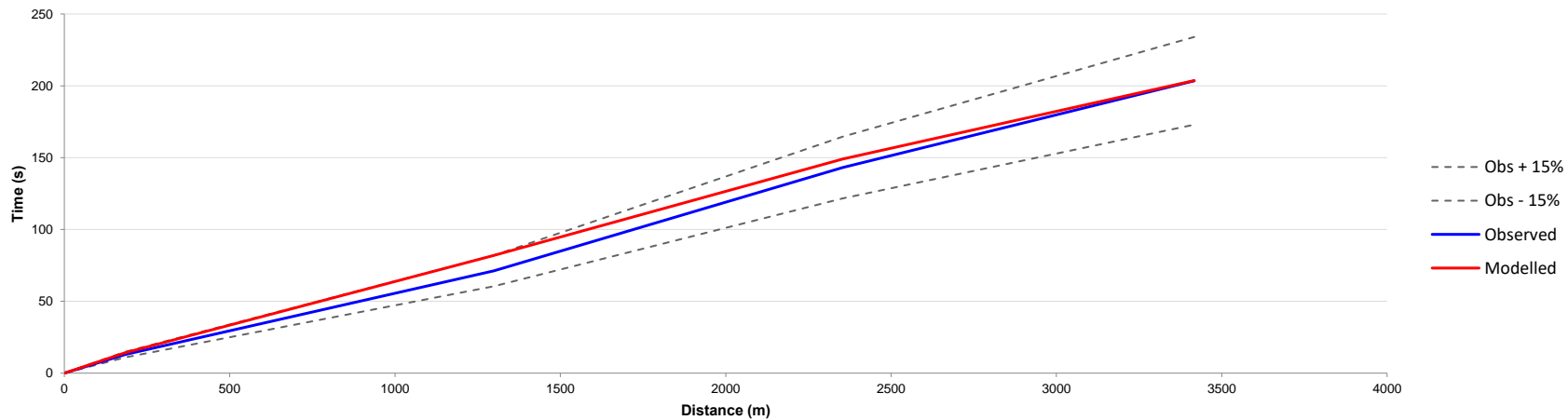



Journey Times Validation Statistics

IP Peak

Journey Time Summary for Group Number 2

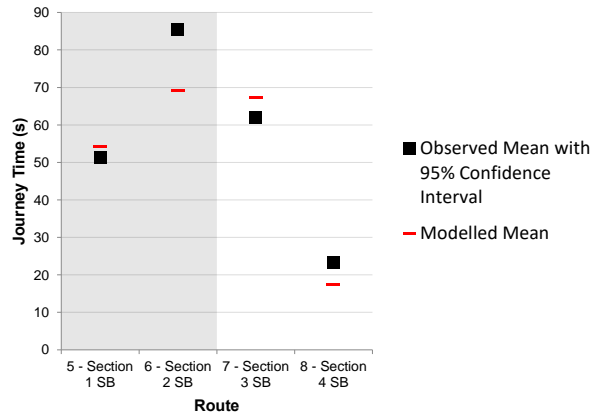

Journey Time Summary by Distance for Group Number 2

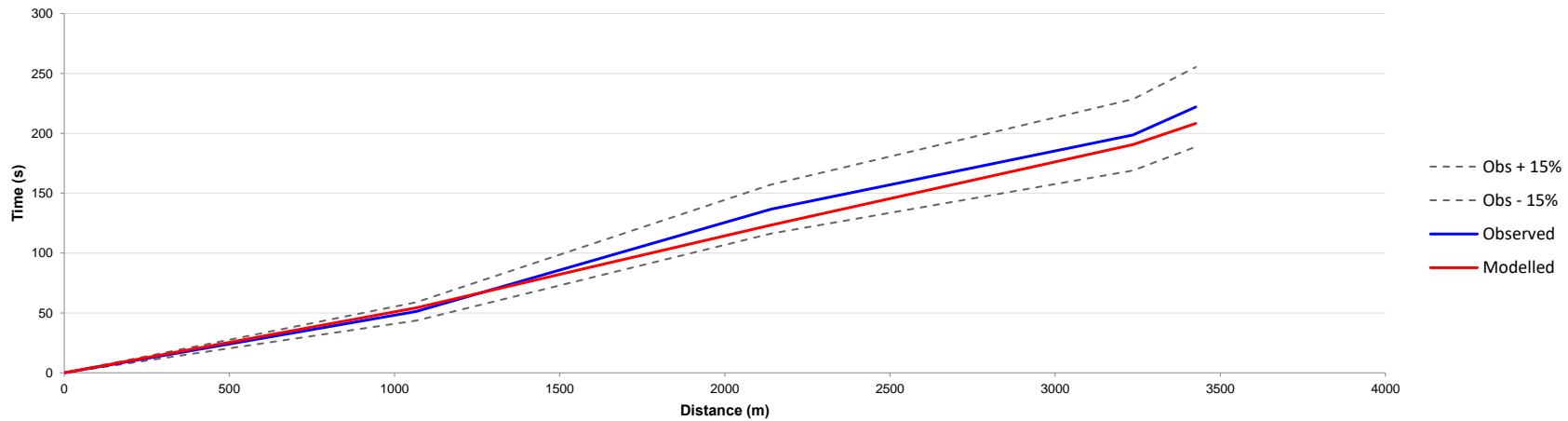



Journey Times
Validation Statistics

PM Peak

Route:	Segment	Graph Group	Observed		Modelled			% Diff	Diff	Conf?	15%	60s	WebTAG	Distance (m)
			Average	95% Conf	Average	95% Conf	Var Chk							
1 - Section 1 NB	Partial - A	1	16		14	0	TRUE	-12.2%	-2	FALSE	TRUE	TRUE	TRUE	185
2 - Section 2 NB	Partial - B	1	57		68	0	TRUE	19.3%	11	FALSE	FALSE	TRUE	TRUE	1114
3 - Section 3 NB	Partial - C	1	67		67	0	TRUE	-1.1%	-1	FALSE	TRUE	TRUE	TRUE	1055
4 - Section 4 NB	Partial - D	1	48		54	0	TRUE	13.2%	6	FALSE	TRUE	TRUE	TRUE	1062
5 - Section 1 SB	Partial - E	2	49		53	0	TRUE	9.0%	4	FALSE	TRUE	TRUE	TRUE	1066
6 - Section 2 SB	Partial - F	2	72		69	1	TRUE	-3.9%	-3	FALSE	TRUE	TRUE	TRUE	1074
7 - Section 3 SB	Partial - G	2	62		67	0	TRUE	9.2%	6	FALSE	TRUE	TRUE	TRUE	1096
8 - Section 4 SB	Partial - H	2	15		17	0	TRUE	16.0%	2	FALSE	FALSE	TRUE	TRUE	190



Journey Time Summary
for Group Number 1

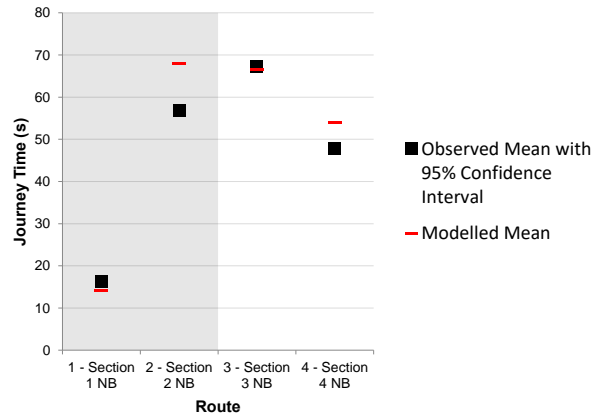

Journey Time Summary by Distance for Group Number 1

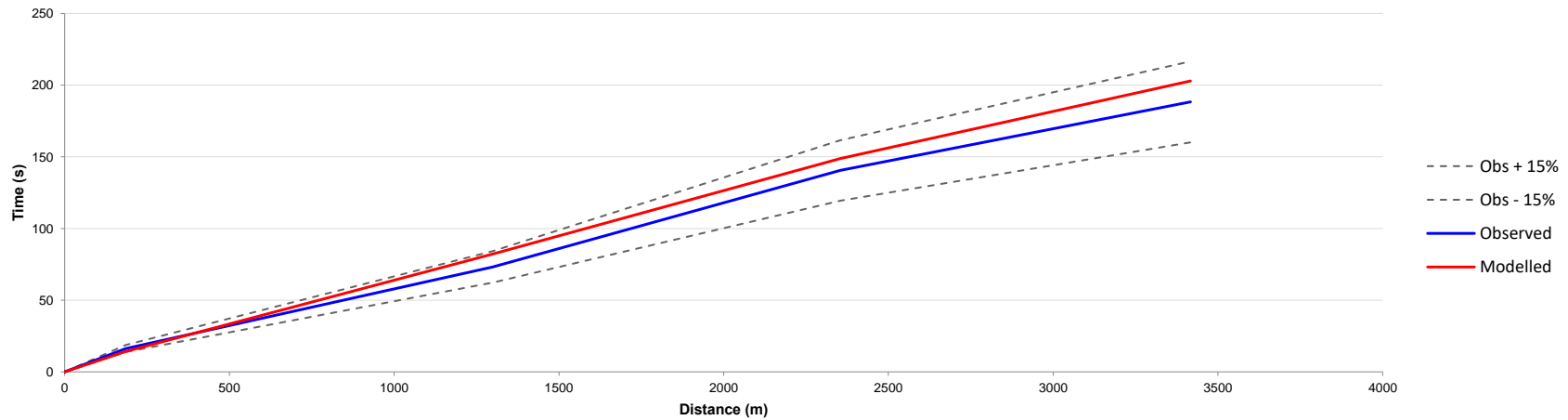



**Journey Time Summary
for Group Number 2**

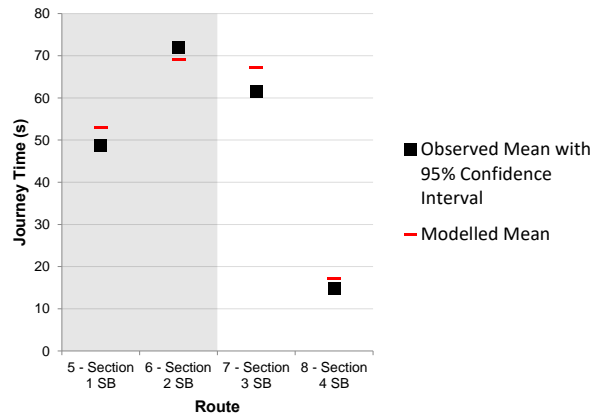

Journey Time Summary by Distance for Group Number 2

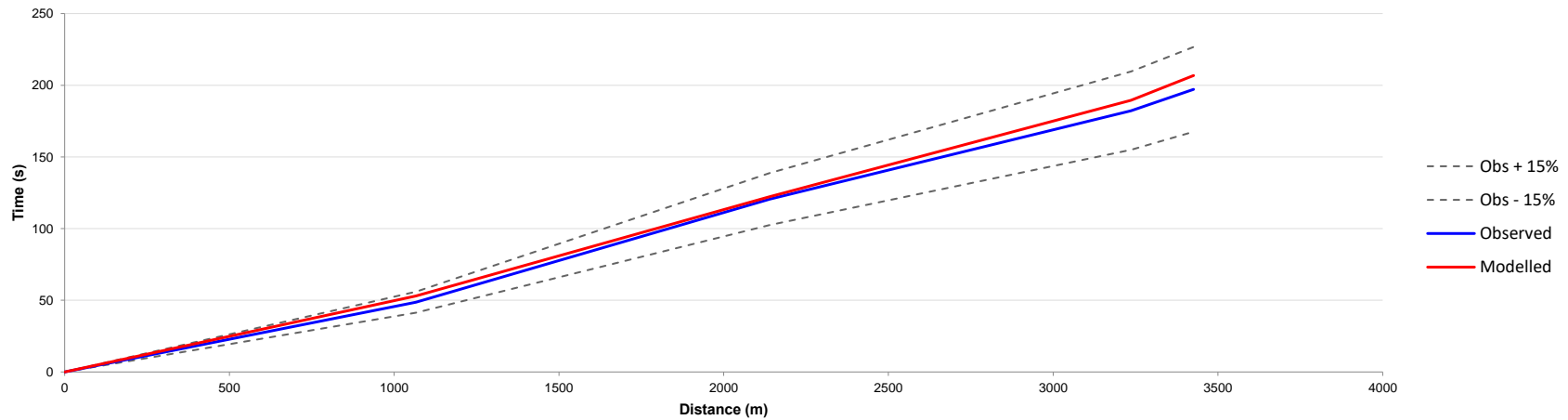

Appendix C

2023 FORECAST MODEL RESULTS





	2015 BY (AM)	2023 RC (AM)	2023 EY (AM)	2015 BY (PM)	2023 RC (PM)	2023 EY (PM)
Total Time Taken (s)	989514	1161272	1332257	1797945	2010877	2199047
Total Distance (m)	17192684	19960686	22488930	31020763	34406446	37033487
Total Vehicles	3124	3602	4159	5858	6505	7102
Total Delay (s)	87147	109403	137900	166614	195509	232980
Average Time (s) / Vehicle	317	322	320	307	309	310
Average Time (s) / Mile	93	94	95	93	94	96
Average Distance (m) / Vehicle	5504	5542	5407	5295	5289	5214
Average Speed (mph)	39	38	38	39	38	38
Average Speed (kph)	63	62	61	62	62	61
Average Delay / Vehicle	28	30	33	28	30	33

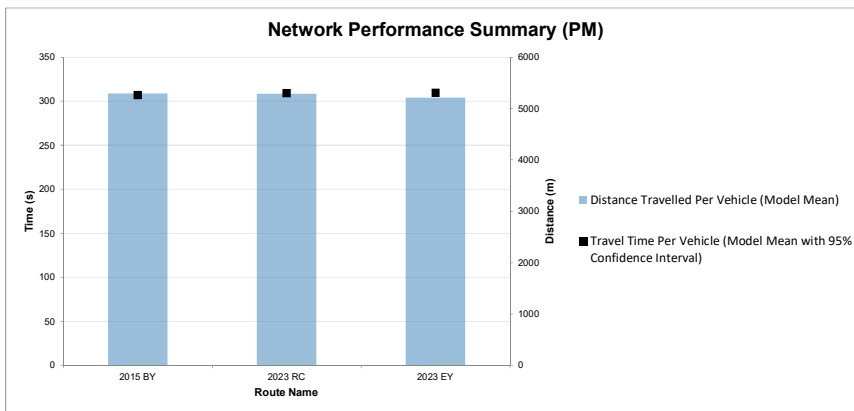
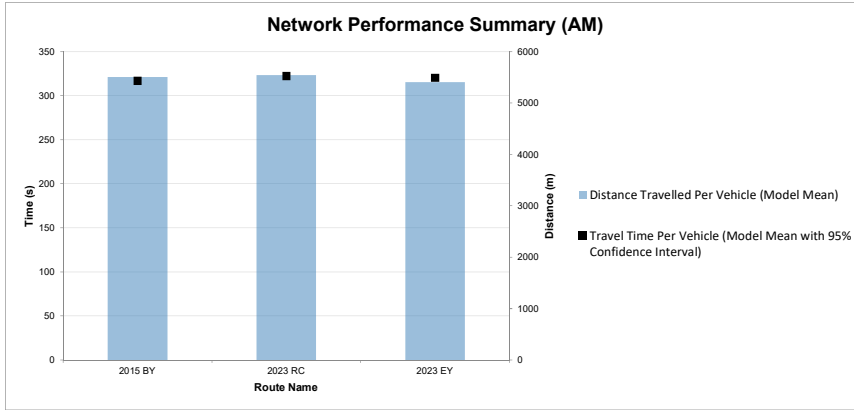



Full Routes Summary (AM)

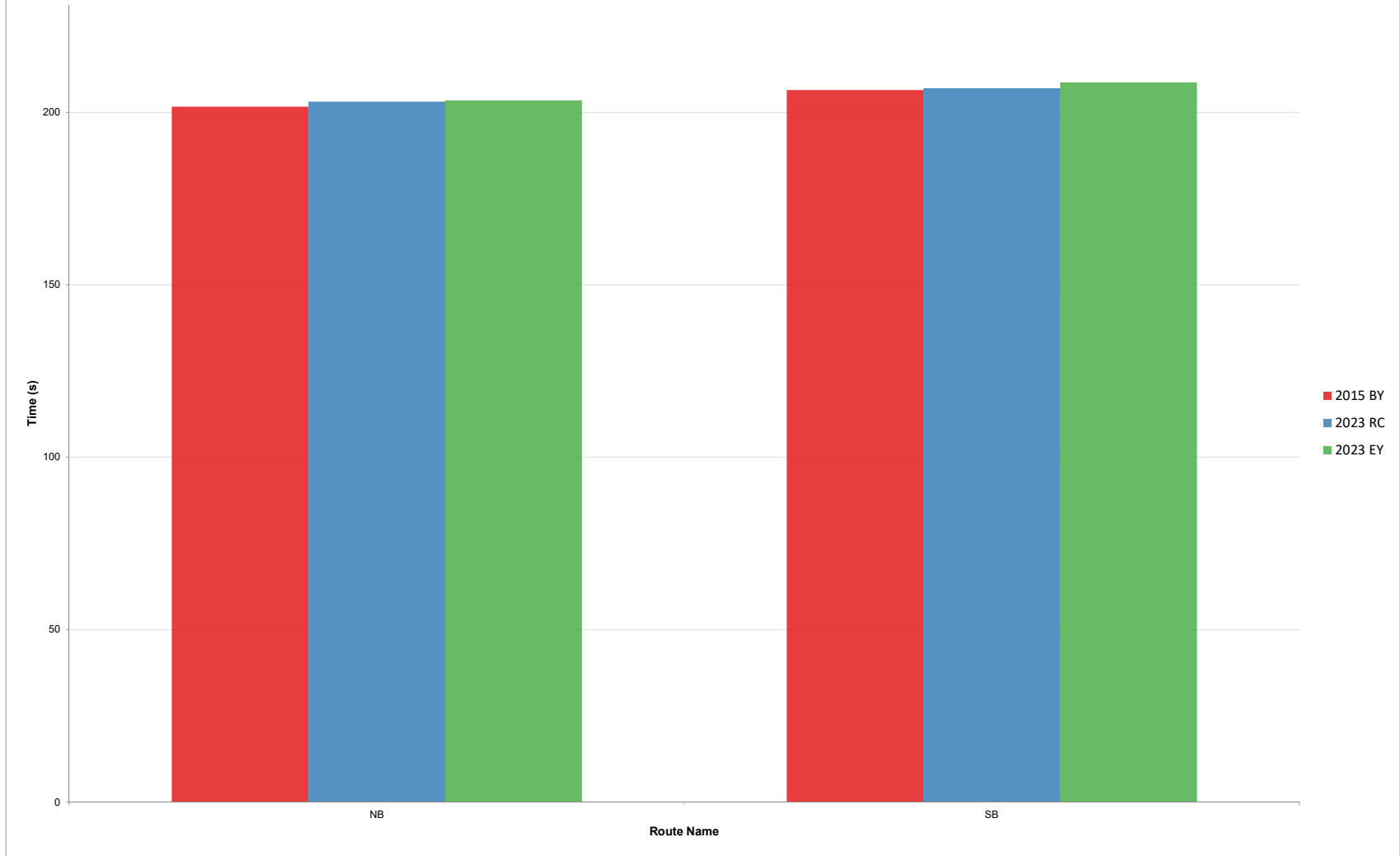



**Journey Time Summary
for NB**

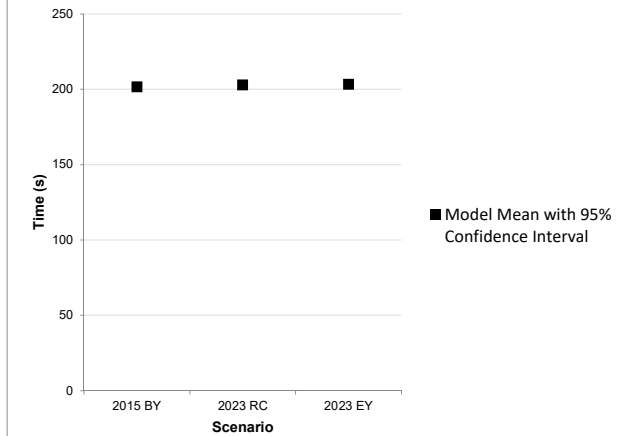

Journey Time Summary by Distance for NB

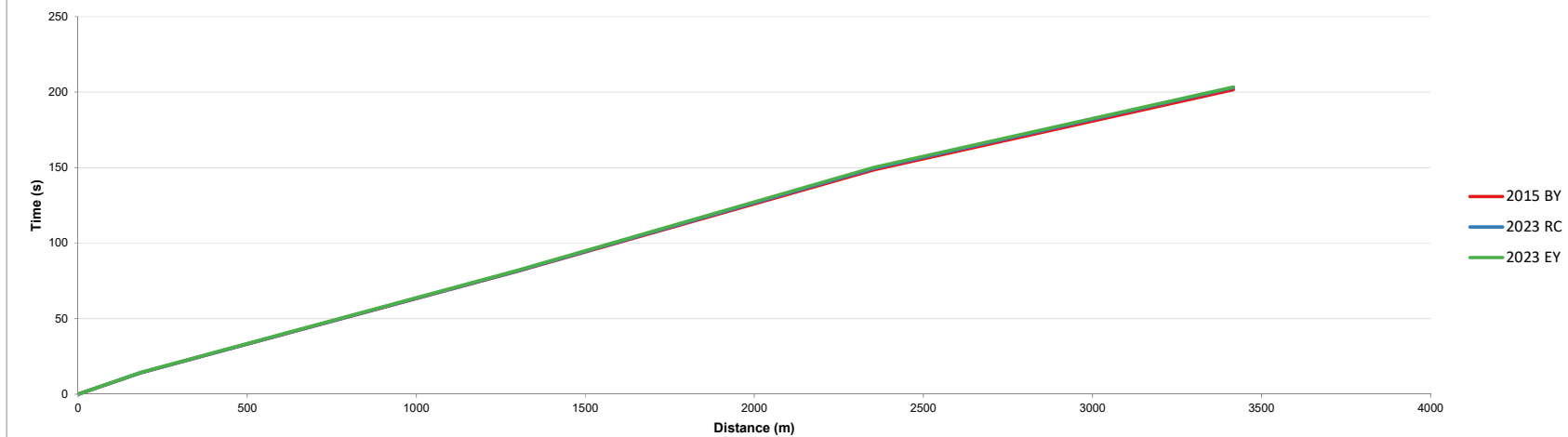



Journey Time Summary for SB

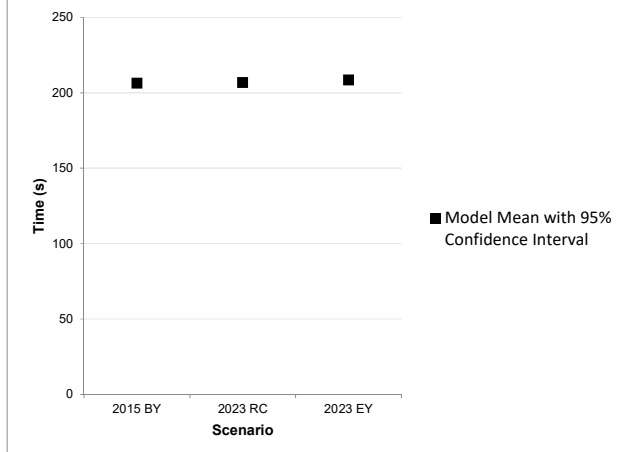

Journey Time Summary by Distance for SB

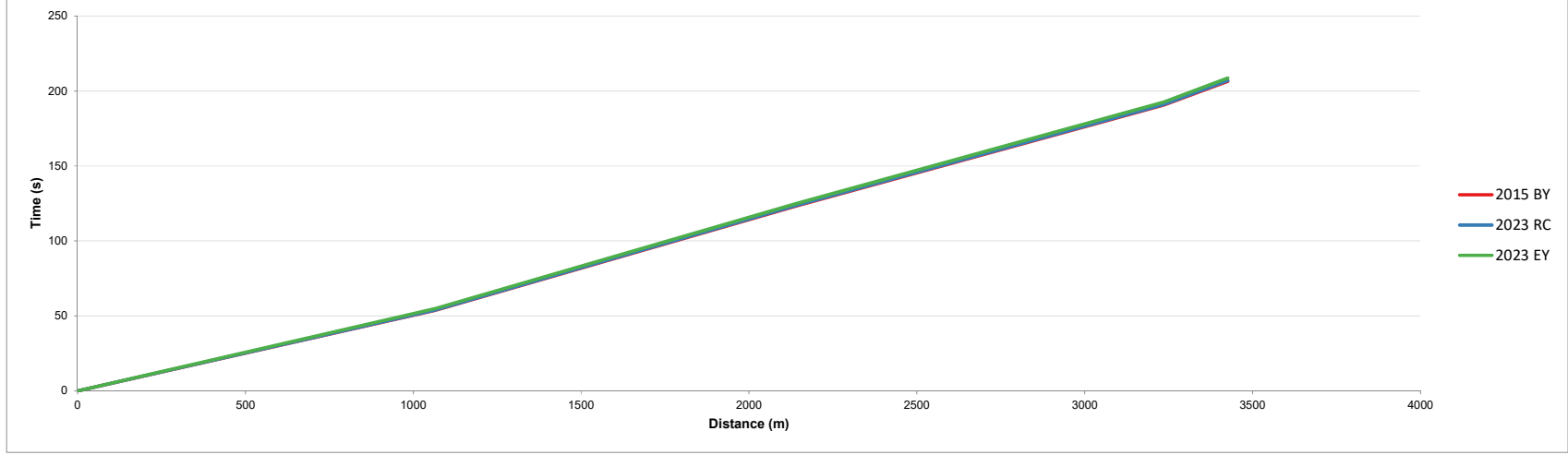

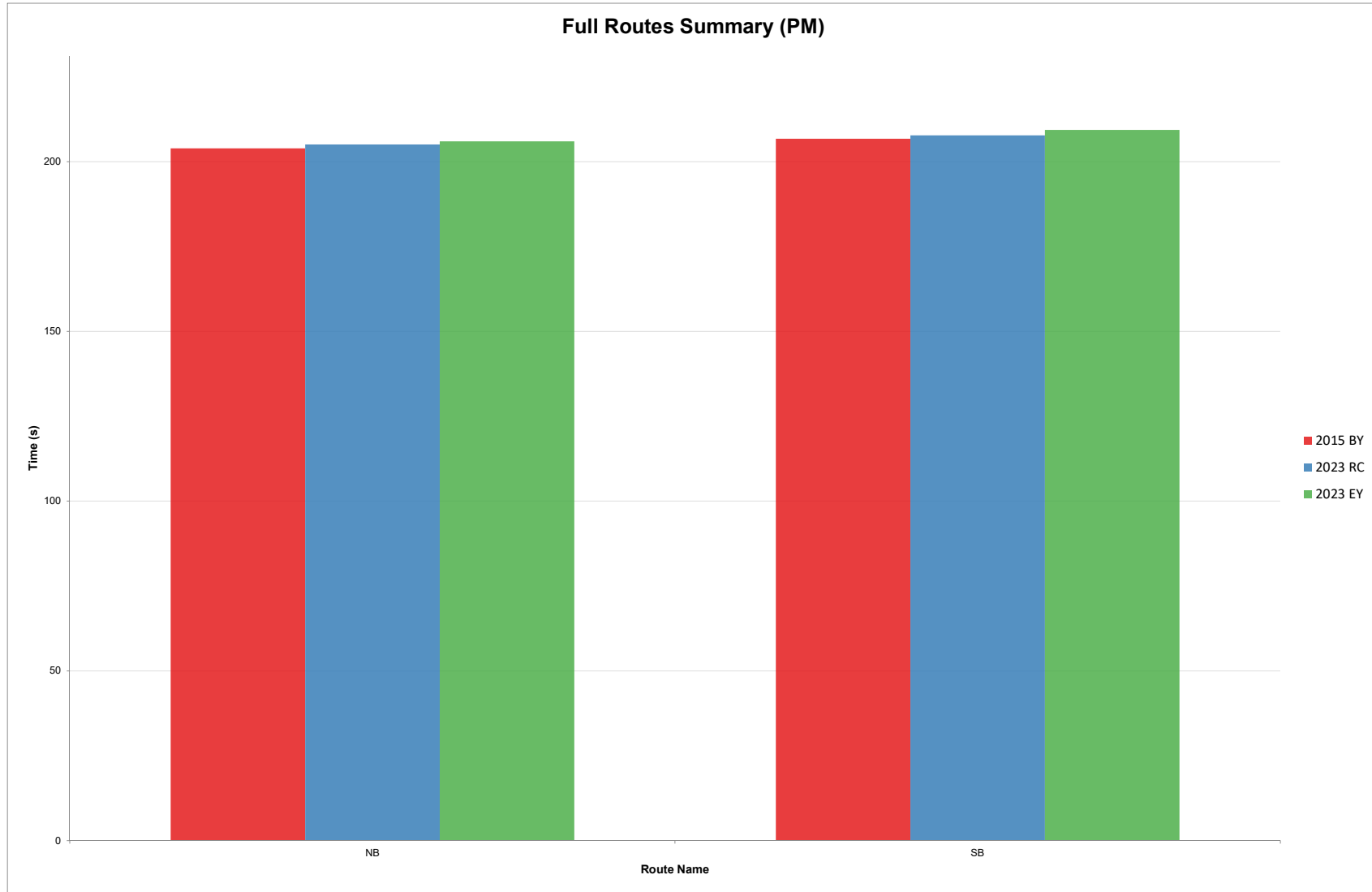

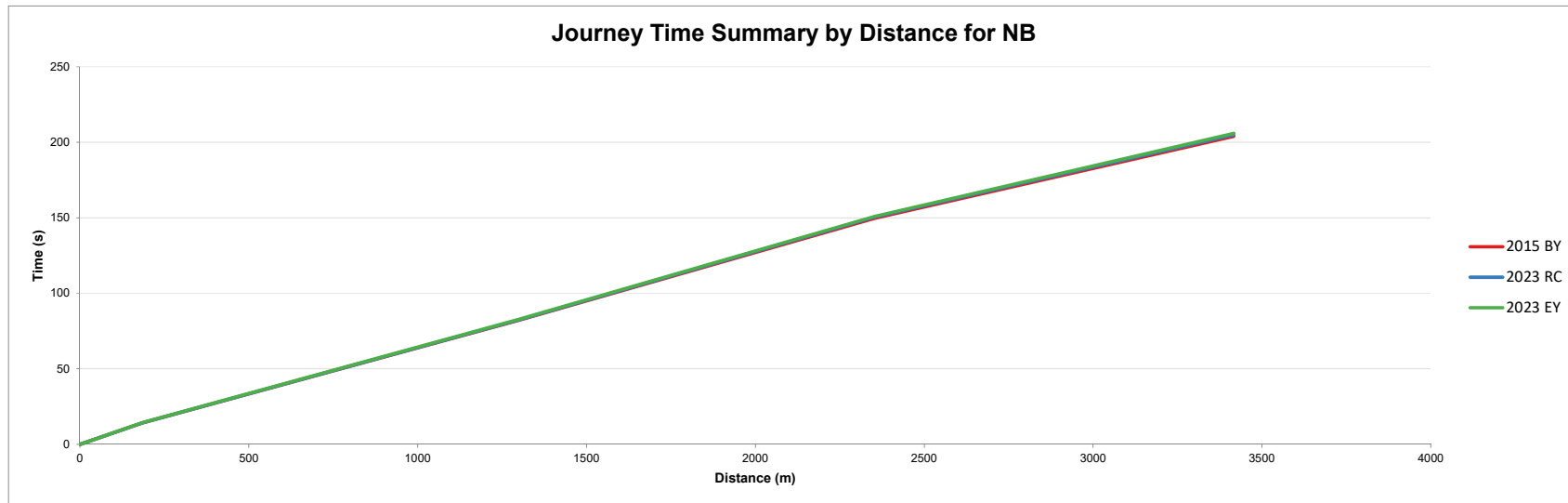
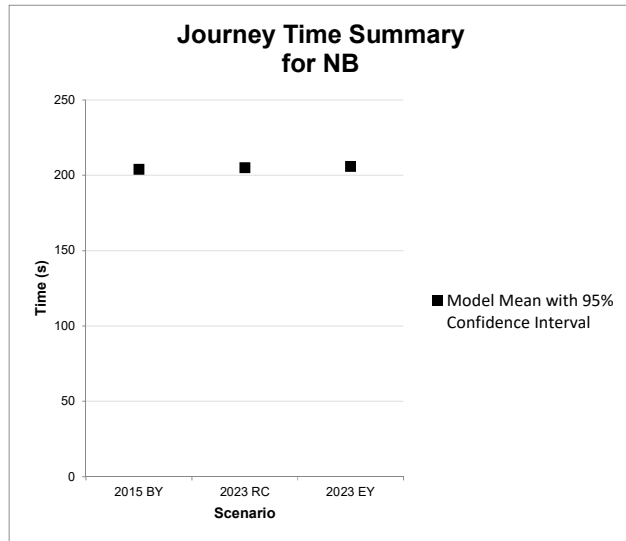



Journey Time Summary for SB

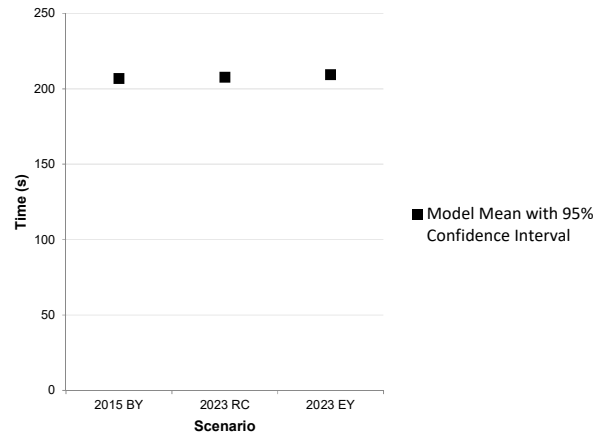

Journey Time Summary by Distance for SB

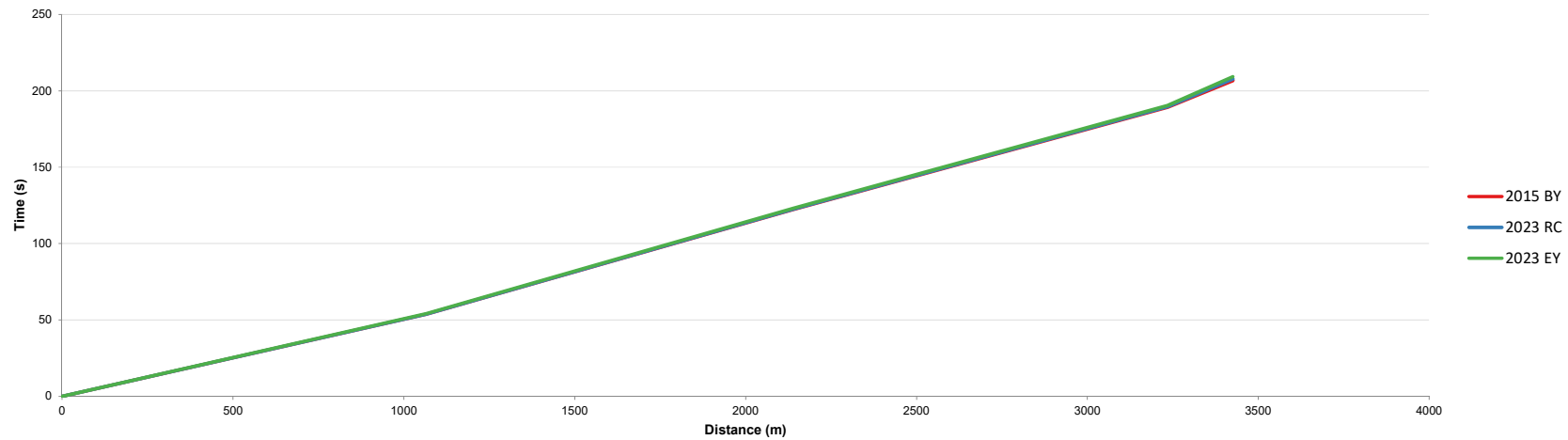



Journey Time Table
AM
2023

Route Names	2015 BY	2023 RC	2023 EY
1 - Section 1 NB	14	14	14
2 - Section 2 NB	67	67	68
3 - Section 3 NB	67	68	68
4 - Section 4 NB	53	54	53
NB	202	203	203
5 - Section 1 SB	54	54	55
6 - Section 2 SB	70	70	70
7 - Section 3 SB	67	68	68
8 - Section 4 SB	16	16	16
SB	206	207	209



Journey Time Table
PM
2023

Route Names	2015 BY	2023 RC	2023 EY
1 - Section 1 NB	14	14	14
2 - Section 2 NB	68	68	68
3 - Section 3 NB	68	68	68
4 - Section 4 NB	54	55	55
NB	204	205	206
5 - Section 1 SB	54	54	54
6 - Section 2 SB	69	69	69
7 - Section 3 SB	67	67	67
8 - Section 4 SB	17	18	19
SB	207	208	209



Queue Comparison
AM
Maximum Length Summary
Maximum Length (m)

	2015 BY	2023 RC	2023 EY
301 - A12 NB turn onto High Street	0.0	0.5	0.7
302 - A12 SB turn onto High Street	37.2	42.5	32.4
303 - High Street(A1120) EB turn	16.0	17.8	27.6
304 - High Street(A1120) EB turn	7.8	10.8	12.9
401 - A12 NB turn onto B1122 EB	12.0	14.2	27.0
402 - B1122 WB turn onto A12 SB	16.1	20.8	55.4
403 - B1122 WB turn onto A12 NB	16.2	19.3	53.8
404 - A12 SB turn onto B1122 EB	0.0	0.0	0.0
501 - A12 NB turn onto Westleton Road	8.6	8.1	8.4
502 - Westleton Road WB turn onto A12 NB	5.7	9.4	6.4
503 - Westleton Road WB turn onto A12 SB	3.6	7.8	5.5
601 - Darsham Petrol Station turn	11.9	11.8	12.2
602 - Darsham Petrol Station turn	12.4	13.4	13.9
701 - A12 NB turn in to Darsham Lane	27.8	49.8	52.4
801 - A12 NB turn on to The Street	14.4	21.4	30.9
802 - The Street WB turn onto A12 SB	6.6	4.1	6.5
803 - The Street WB turn onto A12 NB	8.8	7.7	6.9
901 - A12 SB turn onto Willow Marsh Lane	4.2	6.4	21.8
902 - Willow Marsh Lane EB turn	3.3	3.5	2.6
903 - Willow Marsh Lane EB turn	4.8	5.5	13.4
1001 - A12 NB turn onto Lymballs Lane	3.6	4.3	6.3
1002 - Lymballs Lane WB turn onto A12 NB	5.2	4.6	4.6
1003 - Lymballs Lane WB turn onto A12 SB	3.7	4.3	3.9
1101 - A12 SB turn onto A144 WB	6.9	7.5	7.1
1102 - A144 EB turn onto A12 NB	61.7	69.3	91.1
1103 - A144 EB turn onto A12 SB	62.0	70.4	91.0
1104 - A12 SB turn onto A144 WB first queue			
1201 - Level Crossing A12 NB	107.8	113.3	125.4
1202 - Level Crossing A12 SB	161.3	176.6	187.5
1301 - Level Crossing B1122 EB	22.0	22.3	30.0
1302 - Level Crossing B1122 WB	6.9	12.2	16.8
1401 - PandR Roundabout A12 NB			
1402 - PandR Roundabout PandR Access			
1403 - PandR Roundabout A12 SB			
904 - PandR Access SB turn onto Willow Marsh Lane WB			
905 - Willow Marsh Lane EB turn onto PandR Access NB			
906 - Willow Marsh Lane EB turn onto PandR Access SB			

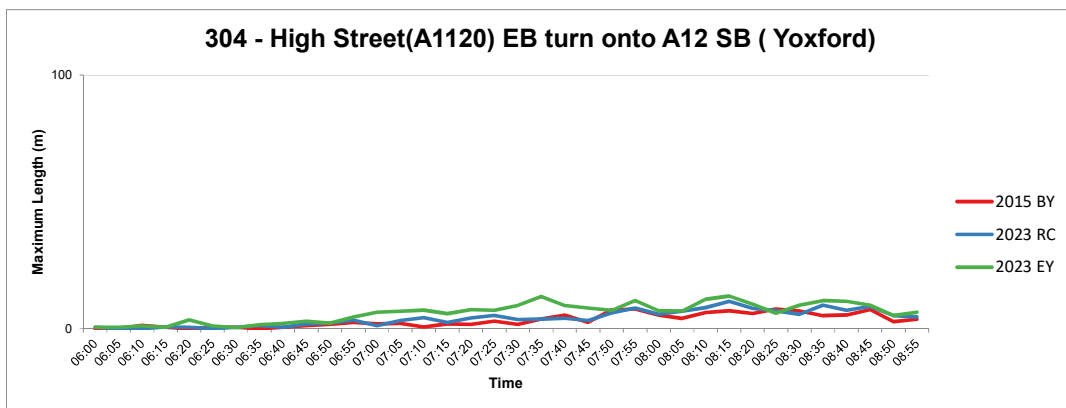
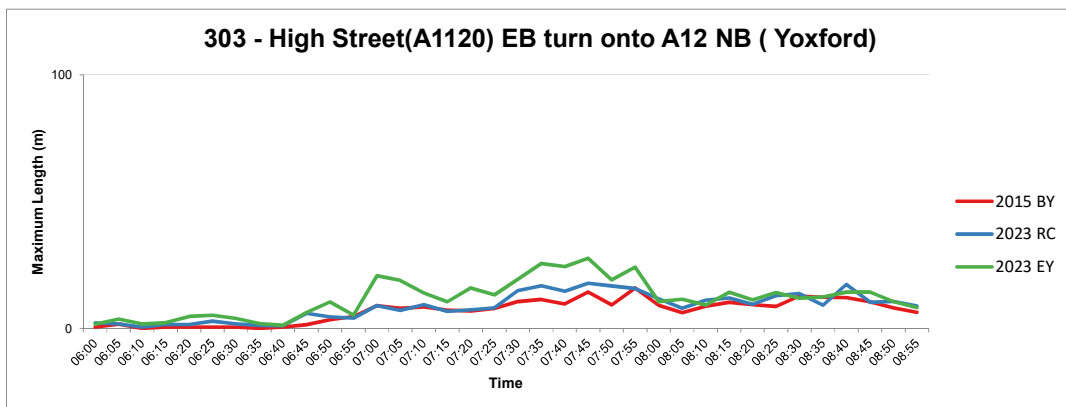
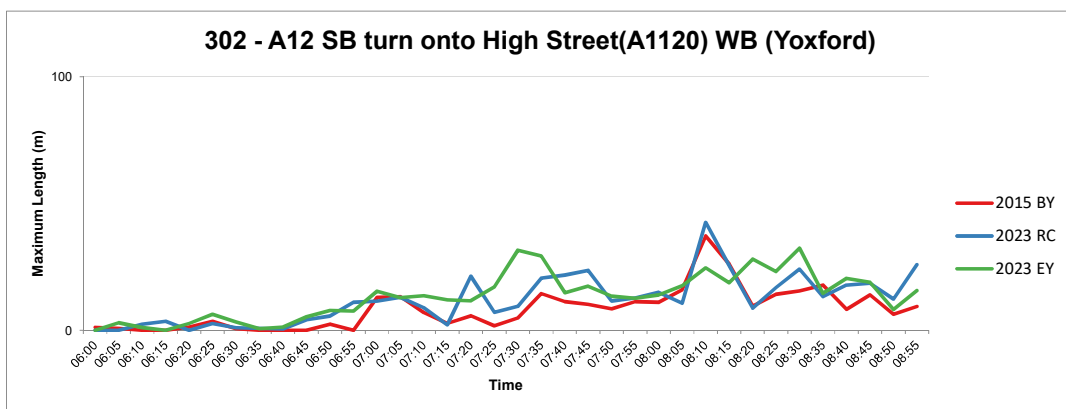
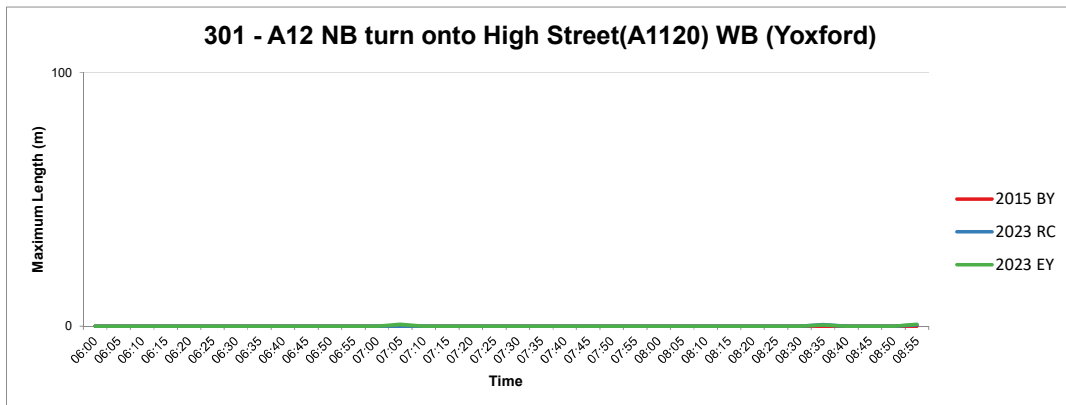

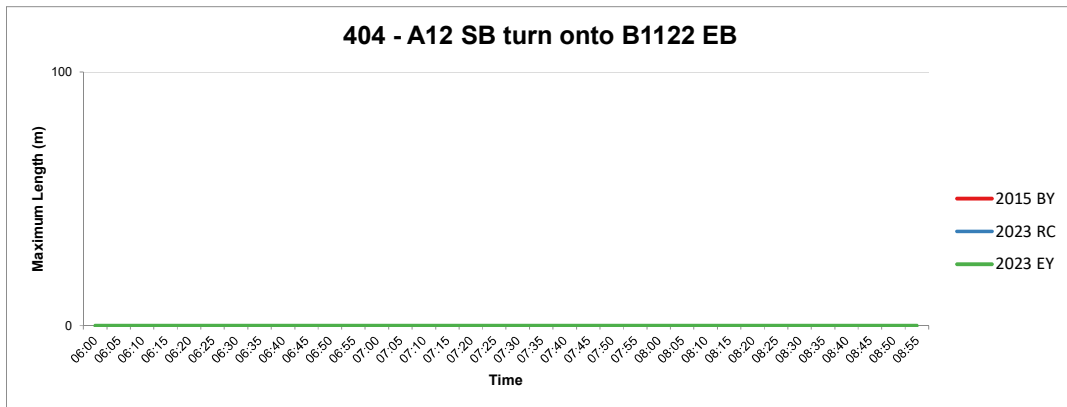
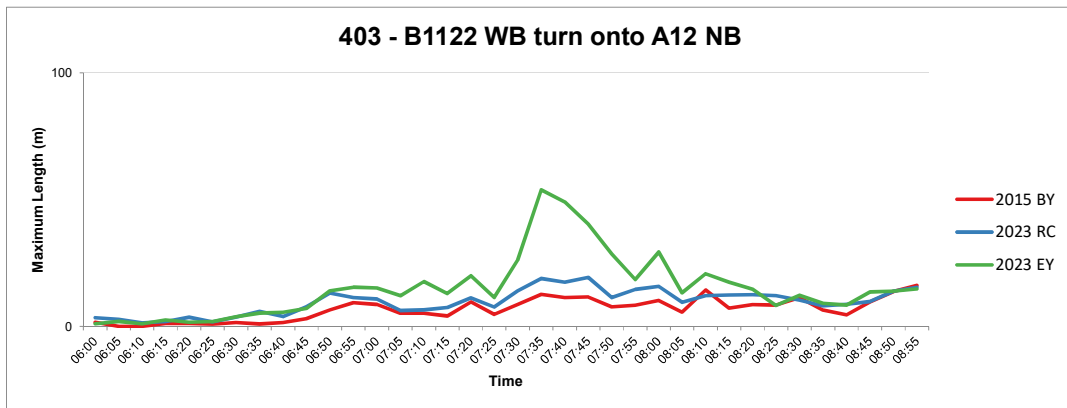
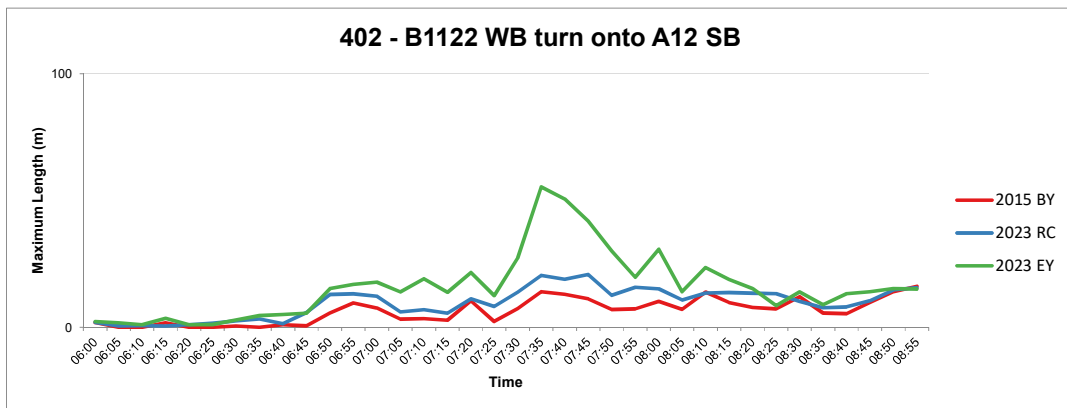
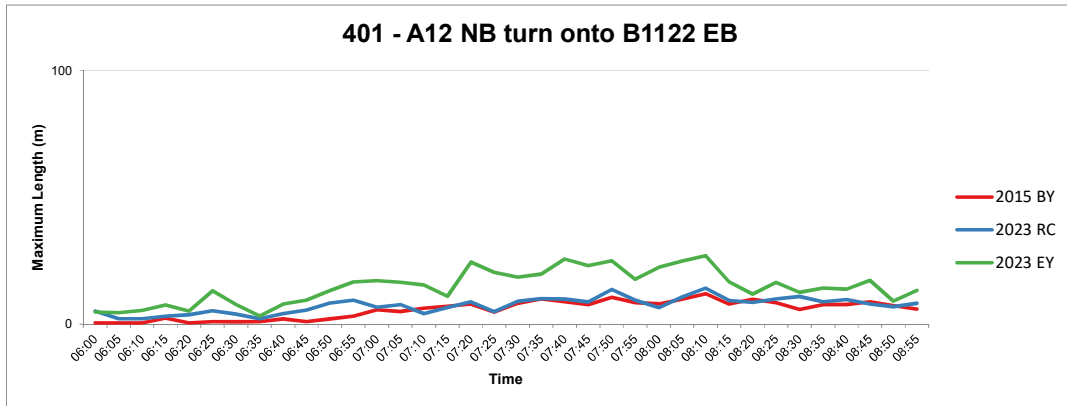

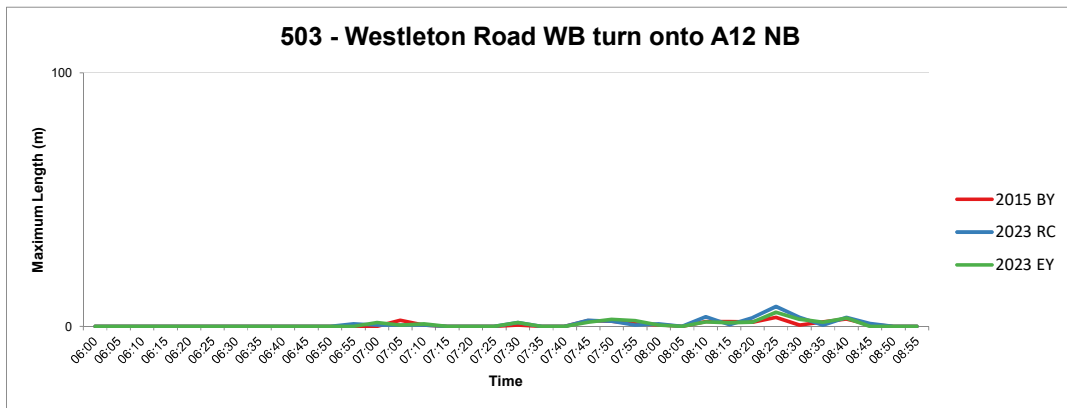
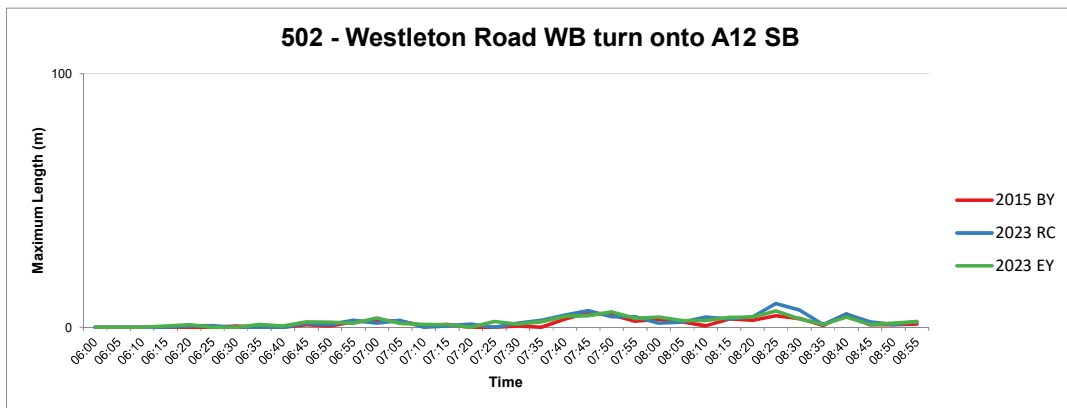
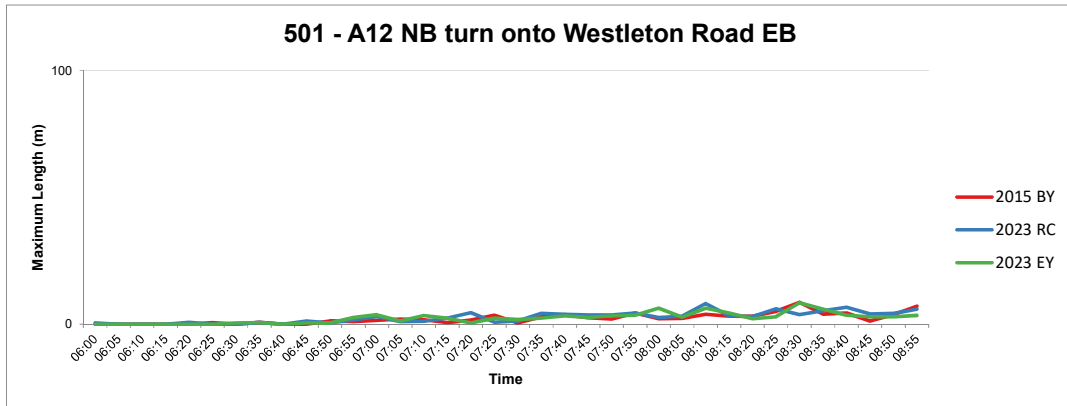

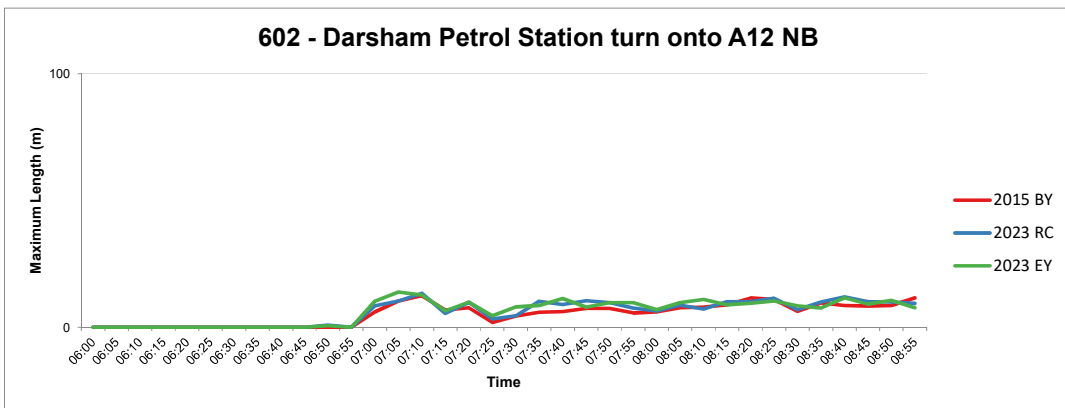
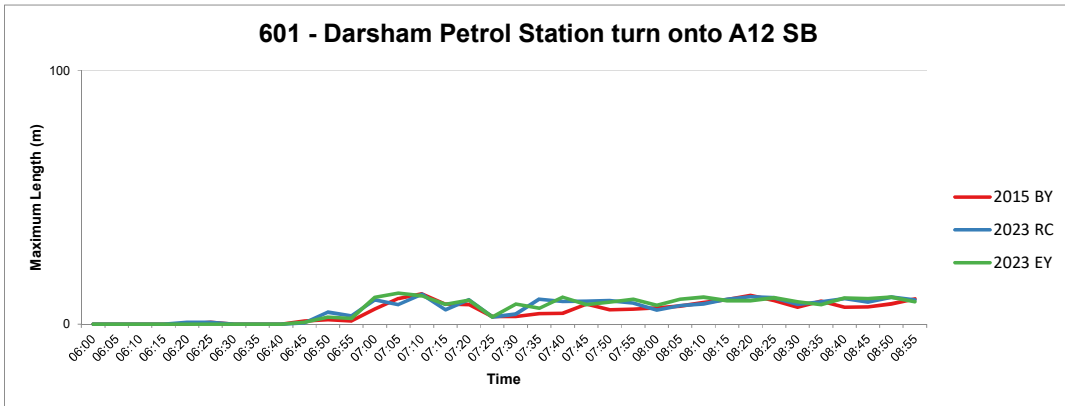

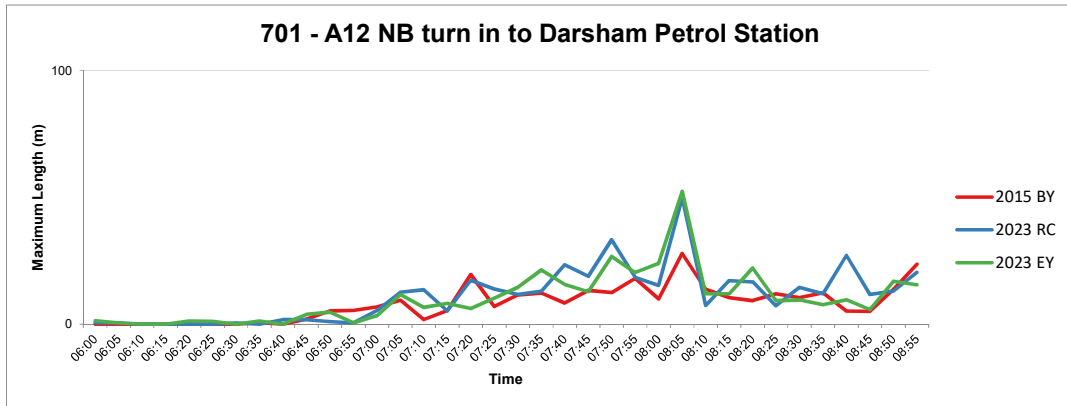

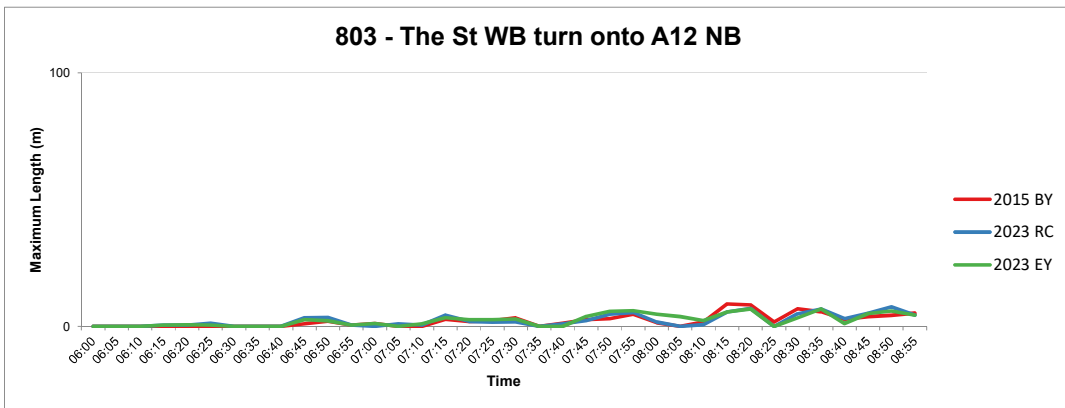
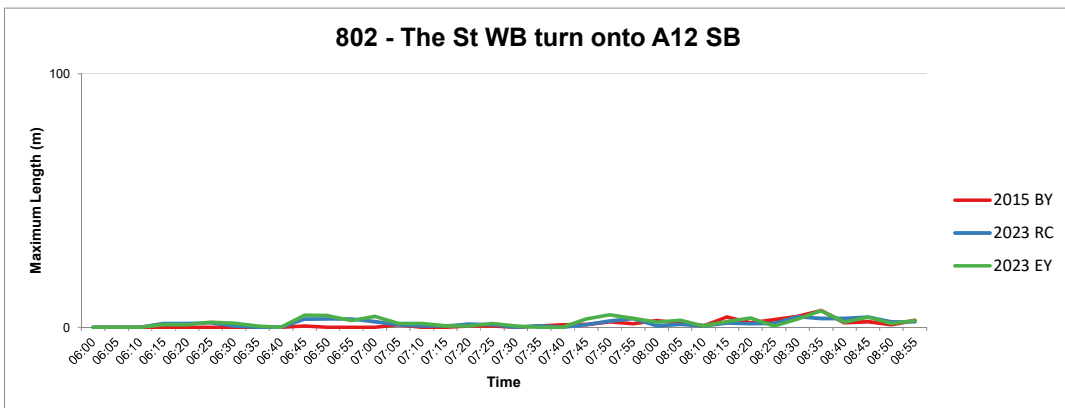
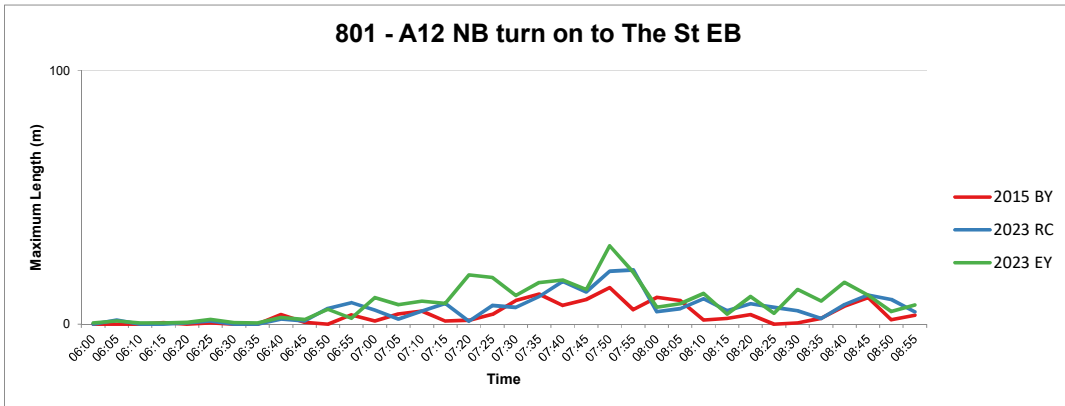

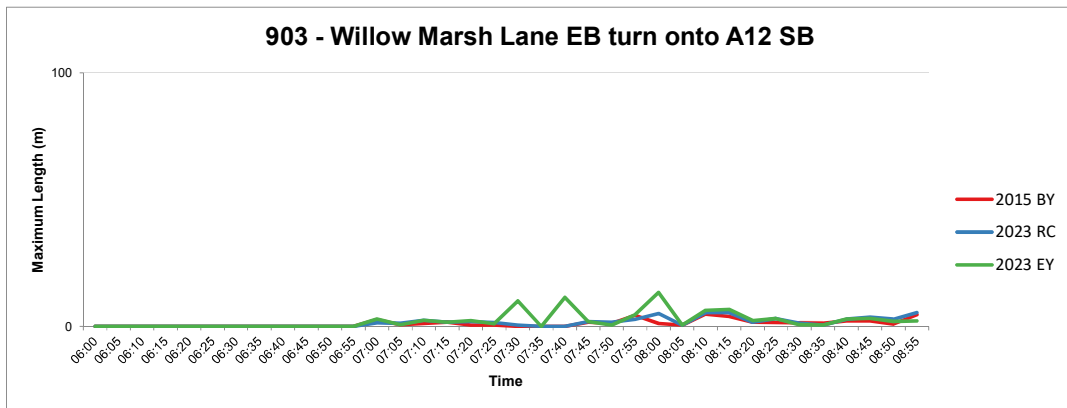
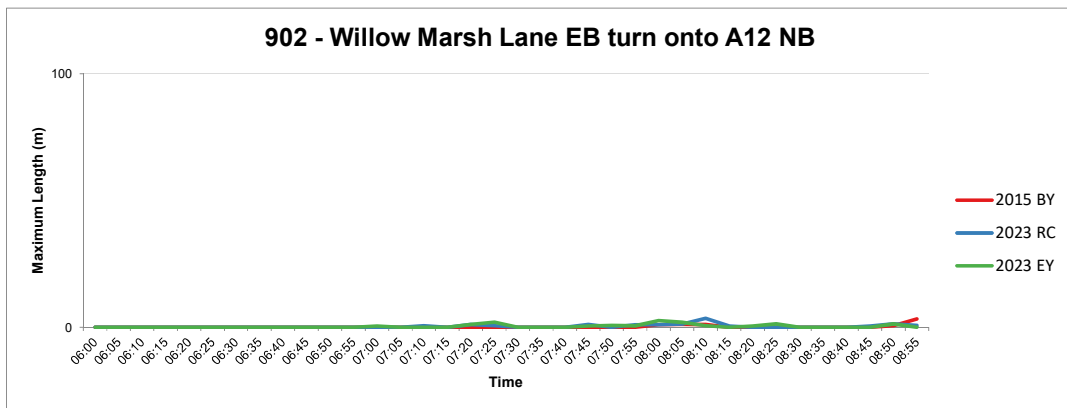
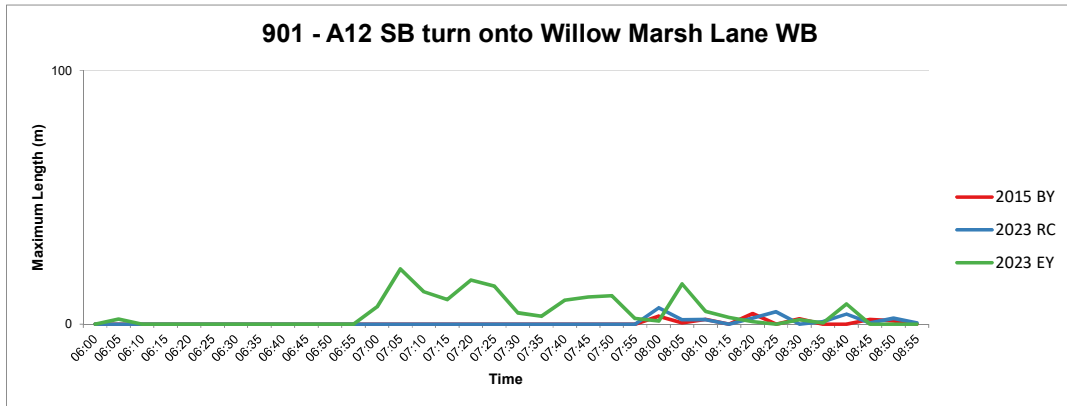

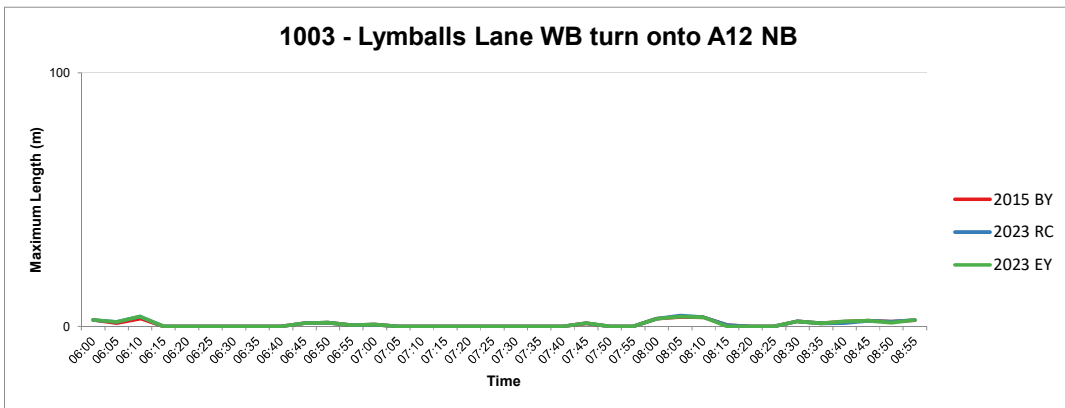
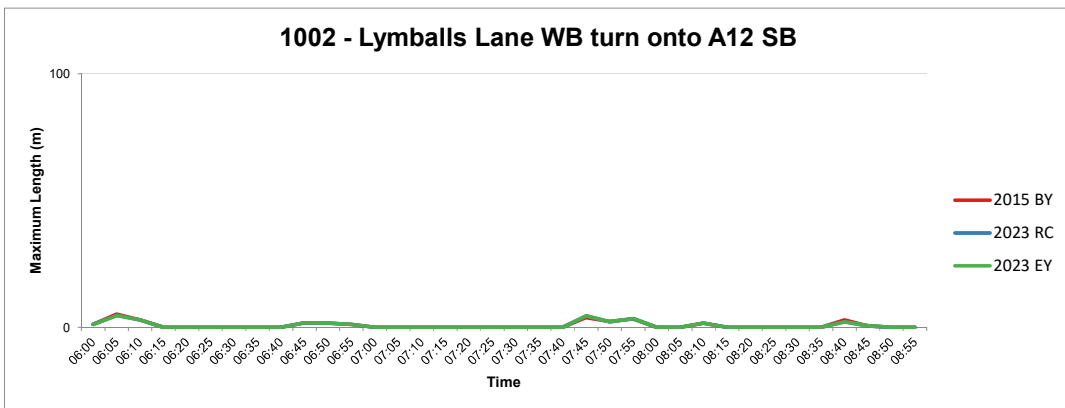
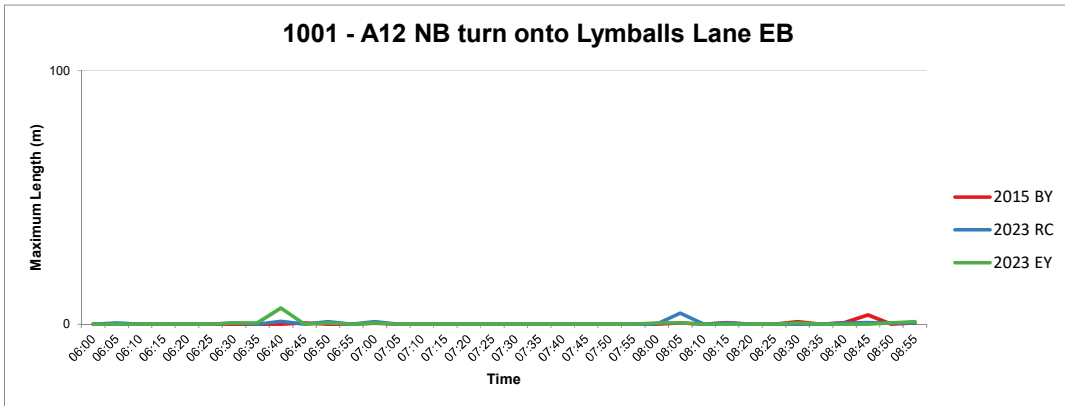

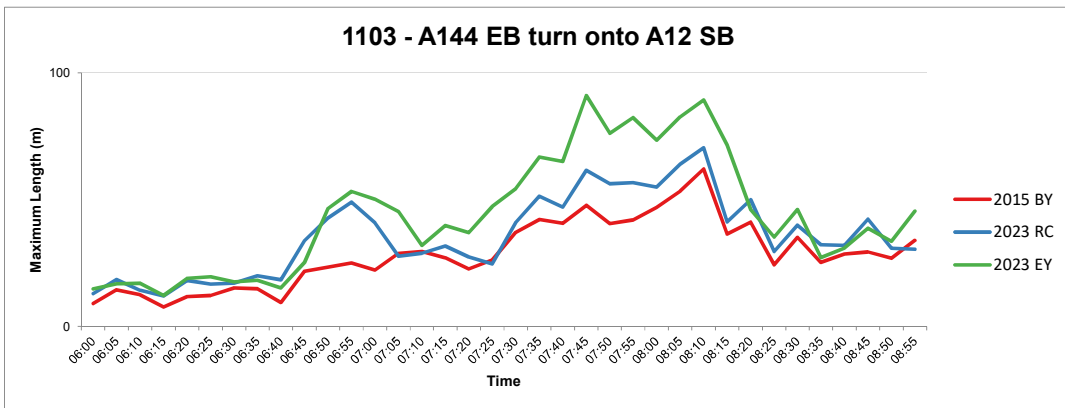
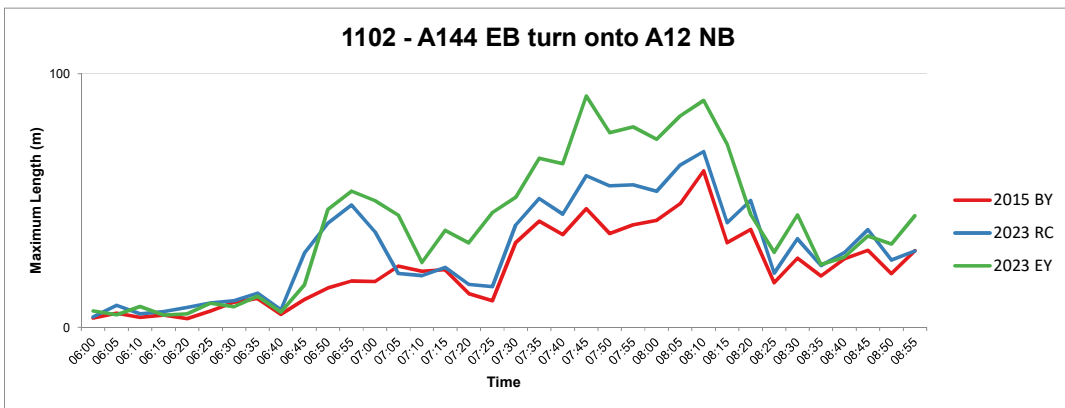
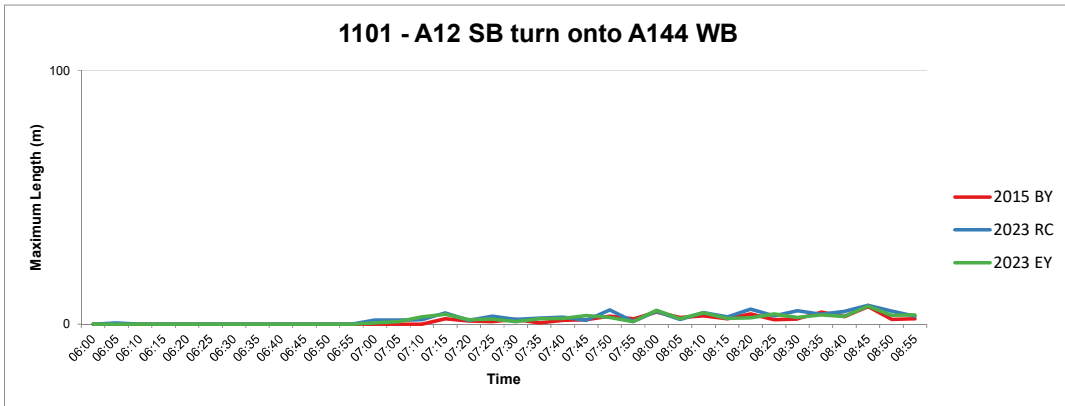

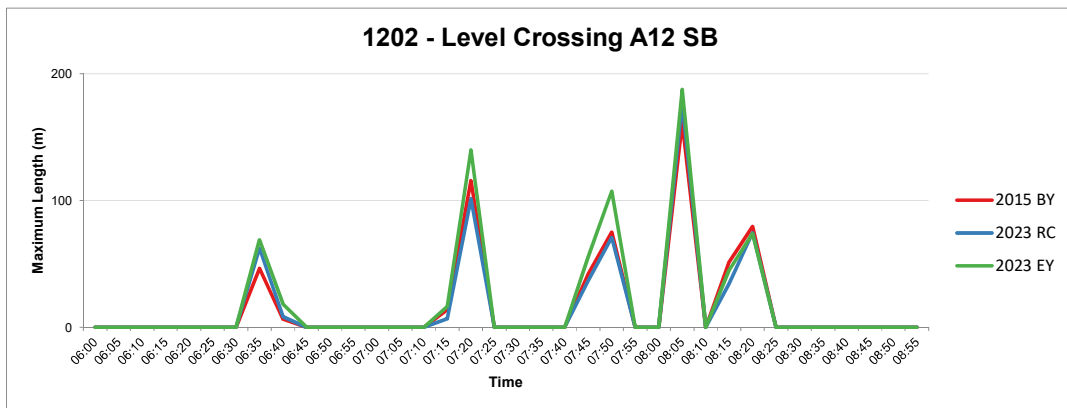
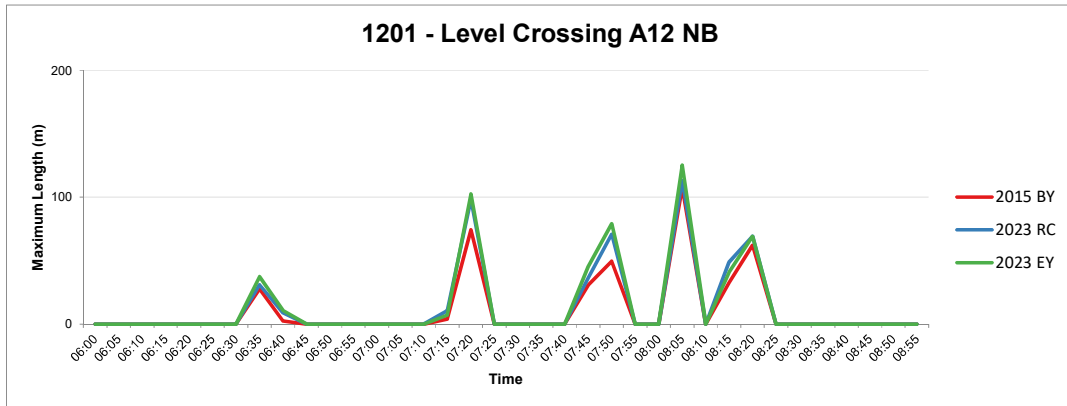

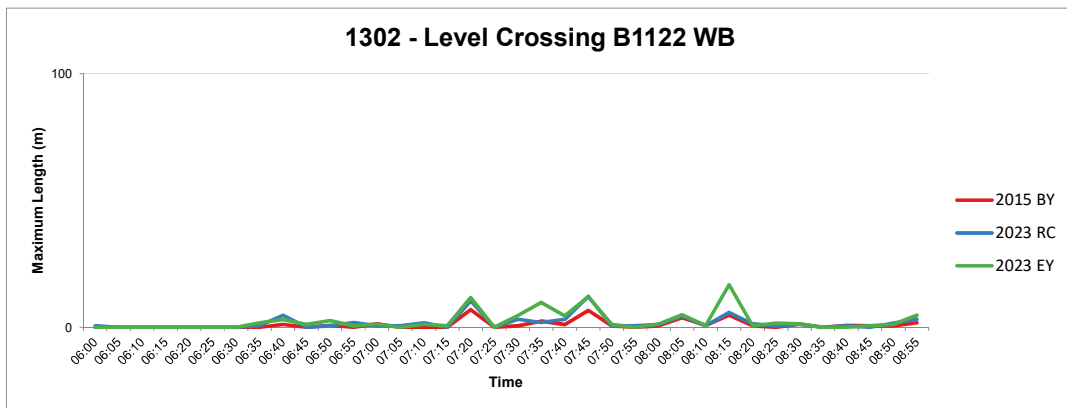
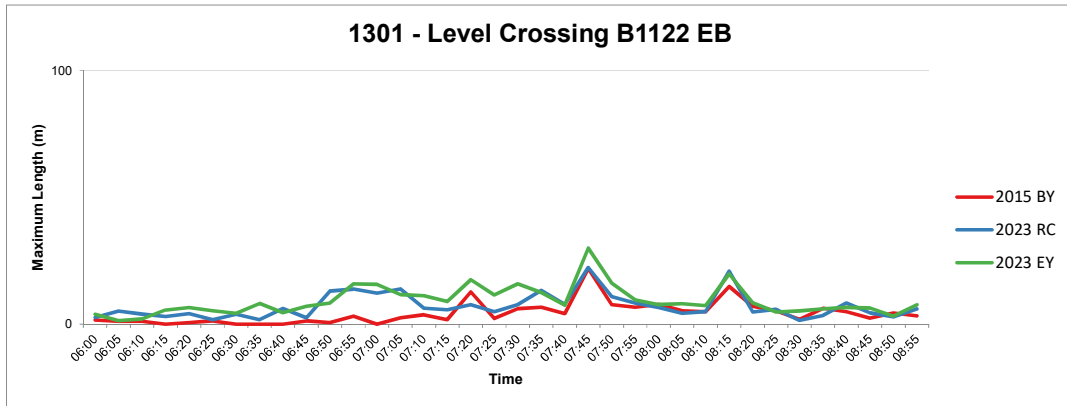



Queue Comparison
PM
Maximum Length Summary
Maximum Length (m)

	2015 BY	2023 RC	2023 EY
301 - A12 NB turn onto High Stre	2.1	1.9	3.1
302 - A12 SB turn onto High Stre	51.0	71.0	85.7
303 - High Street(A1120) EB turn	15.9	18.8	20.2
304 - High Street(A1120) EB turn	9.4	17.0	12.6
401 - A12 NB turn onto B1122 E	7.9	9.8	18.2
402 - B1122 WB turn onto A12 S	41.0	55.8	77.3
403 - B1122 WB turn onto A12 N	39.5	54.3	75.8
404 - A12 SB turn onto B1122 E	0.0	0.0	1.7
501 - A12 NB turn onto Westleto	4.4	6.7	6.1
502 - Westleton Road WB turn o	9.9	11.3	10.9
503 - Westleton Road WB turn o	7.2	8.4	8.0
601 - Darsham Petrol Station tur	11.2	13.2	12.3
602 - Darsham Petrol Station tur	11.5	12.9	13.4
701 - A12 NB turn in to Darsham	26.1	62.9	40.4
801 - A12 NB turn on to The St E	16.1	18.1	25.4
802 - The St WB turn onto A12 S	10.1	11.3	11.3
803 - The St WB turn onto A12 N	13.1	12.8	12.1
901 - A12 SB turn onto Willow M	5.6	9.6	13.8
902 - Willow Marsh Lane EB turn	2.3	3.6	27.8
903 - Willow Marsh Lane EB turn	4.9	4.4	27.7
1001 - A12 NB turn onto Lymball	6.7	9.2	4.9
1002 - Lymballs Lane WB turn o	8.6	8.2	8.1
1003 - Lymballs Lane WB turn o	5.8	5.5	5.5
1101 - A12 SB turn onto A144 W	9.3	7.2	7.5
1102 - A144 EB turn onto A12 N	32.0	33.0	35.8
1103 - A144 EB turn onto A12 S	32.8	35.4	38.2
1104 - A12 SB turn onto A144 W	B first queue		
1201 - Level Crossing A12 NB	159.0	191.7	198.1
1202 - Level Crossing A12 SB	95.7	118.0	113.5
1301 - Level Crossing B1122 EB	10.0	11.0	21.3
1302 - Level Crossing B1122 WB	18.1	19.6	32.5
1401 - PandR Roundabout A12 NB			
1402 - PandR Rouandabout PandR Access			
1403 - PandR Roundabout A12 SB			
904 - PandR Access SB turn onto Willow Marsh Lane WB			
905 - Willow Marsh Lane EB turn onto PandR Access NB			
906 - Willow Marsh Lane EB turn onto PandR Access SB			

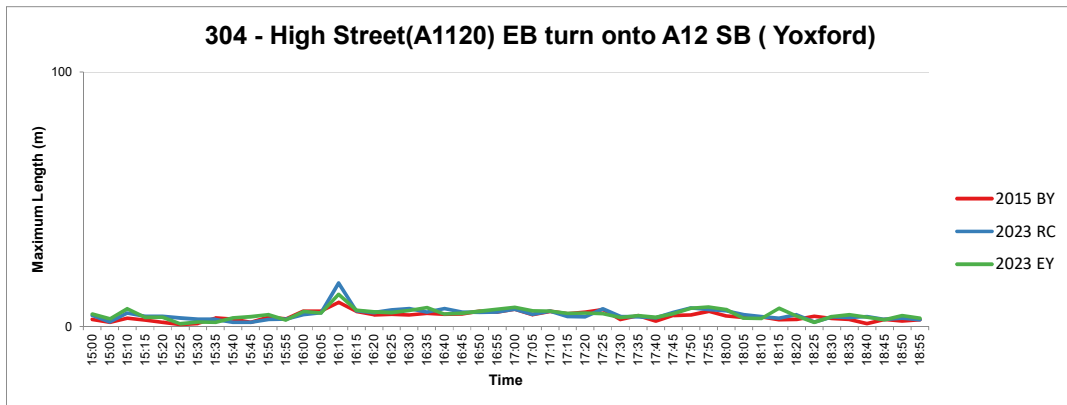
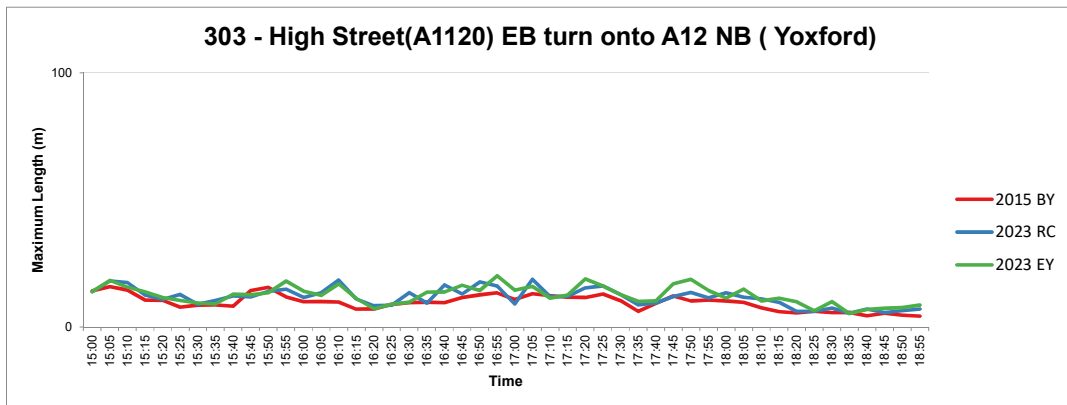
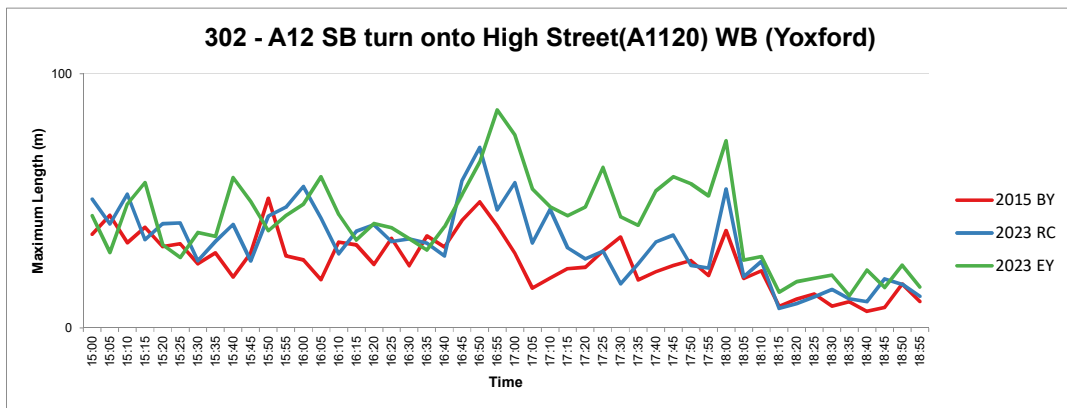
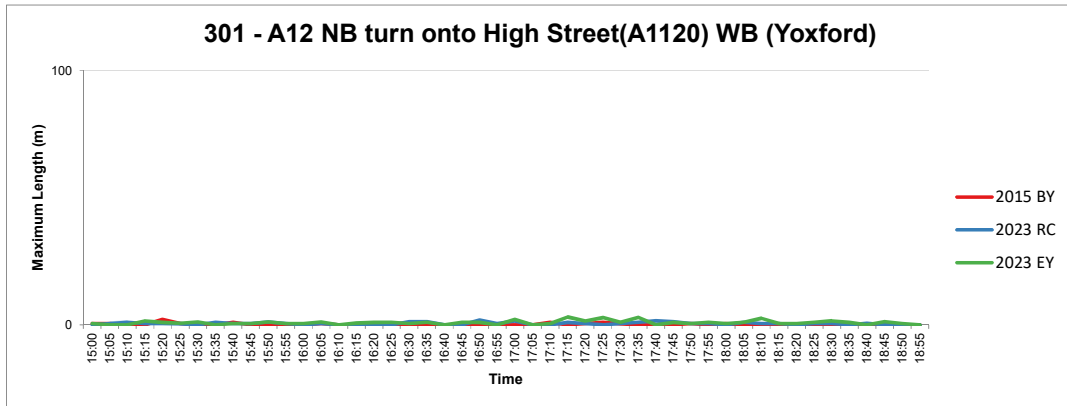

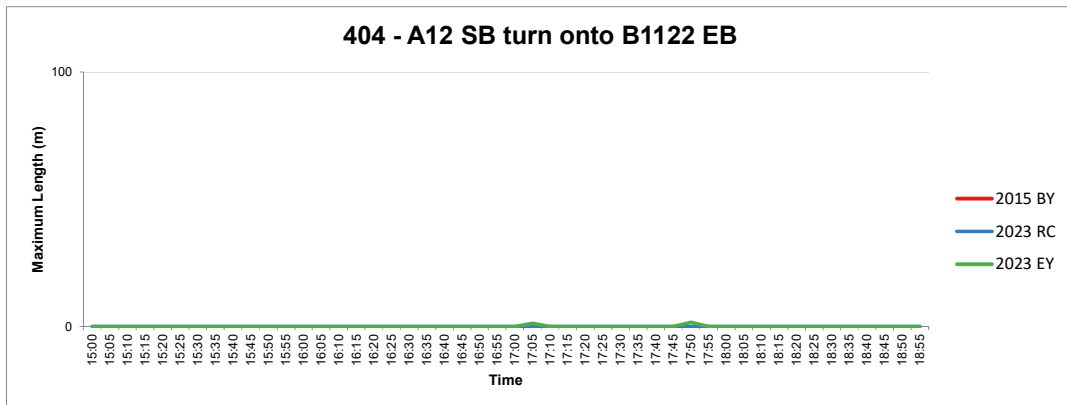
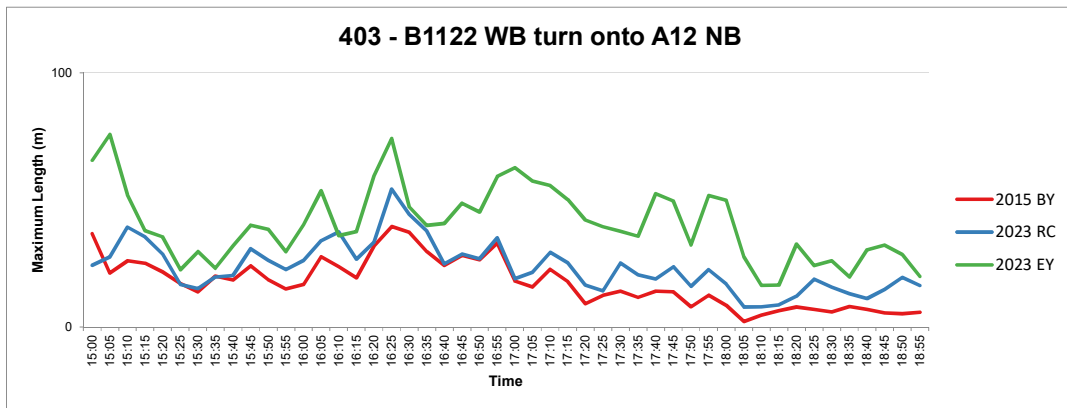
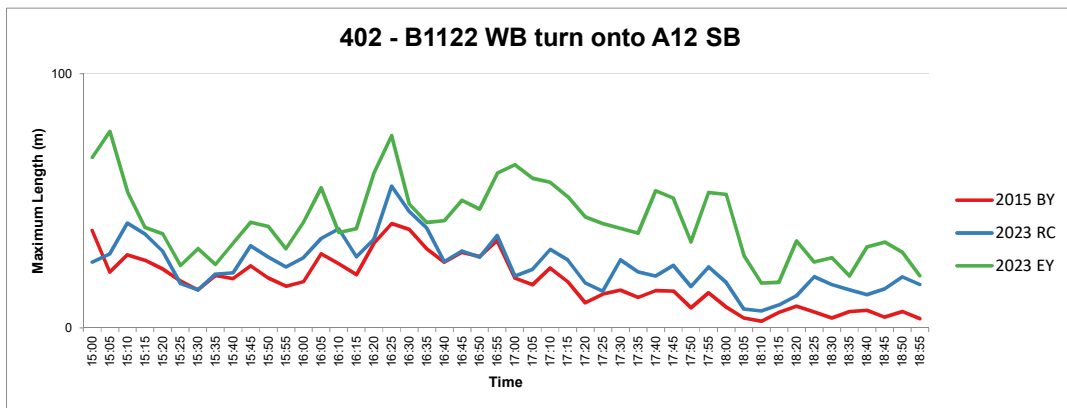
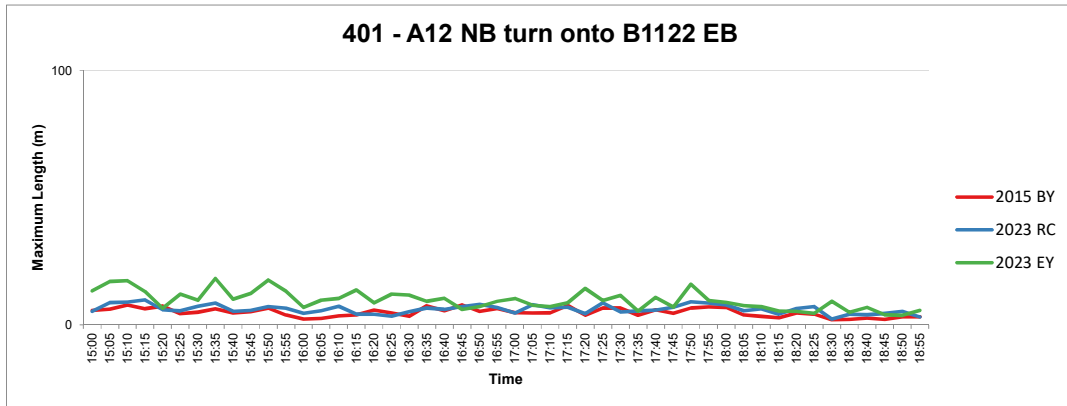

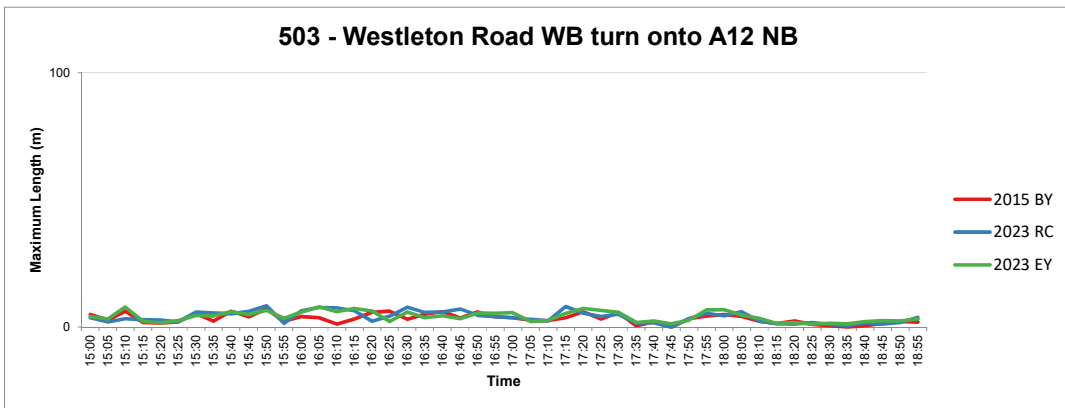
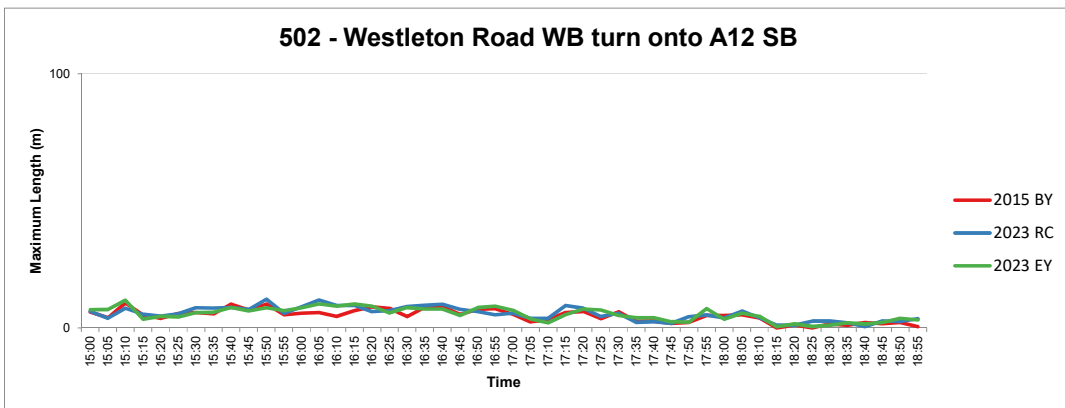
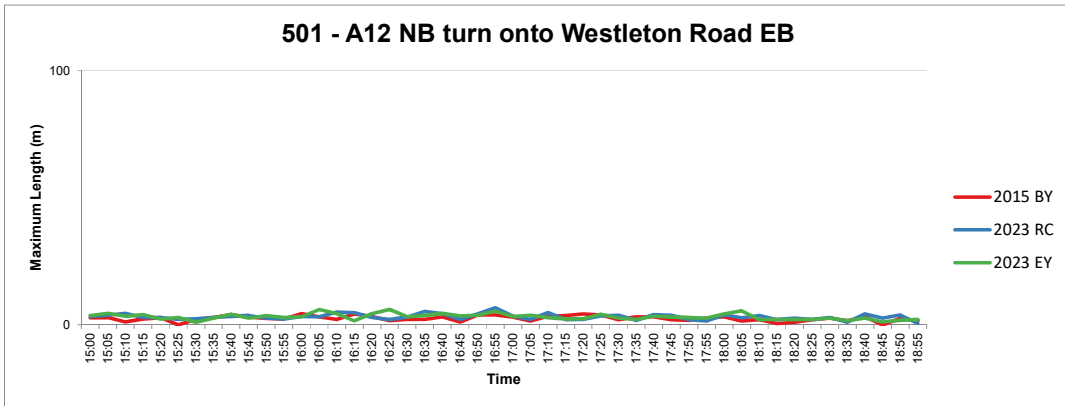



601 - Darsham Petrol Station turn onto A12 SB

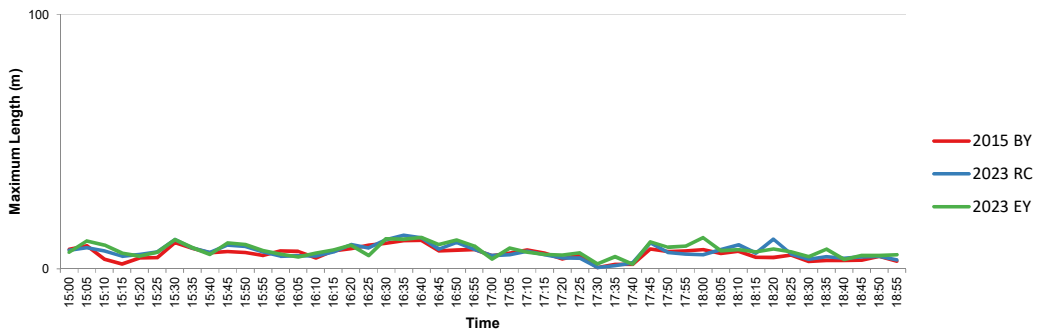

602 - Darsham Petrol Station turn onto A12 NB

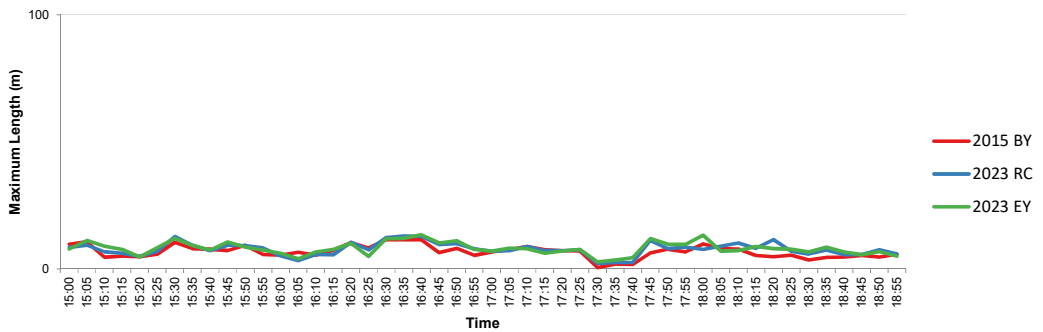

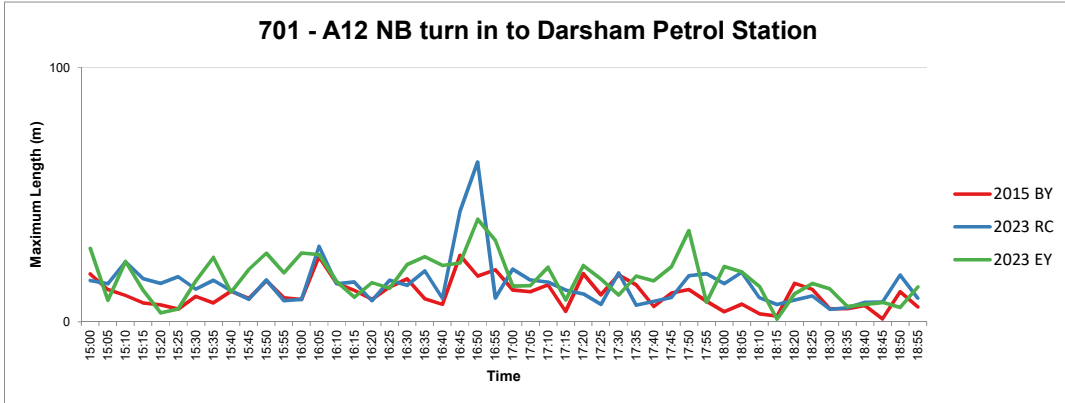

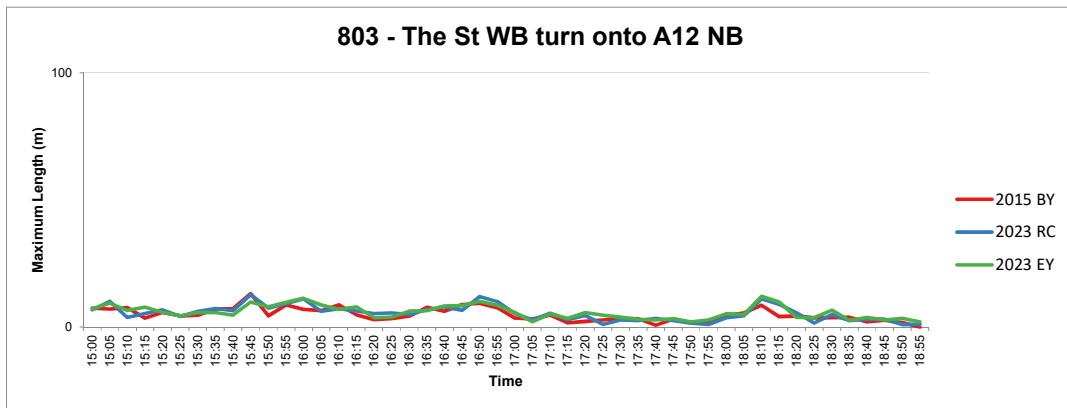
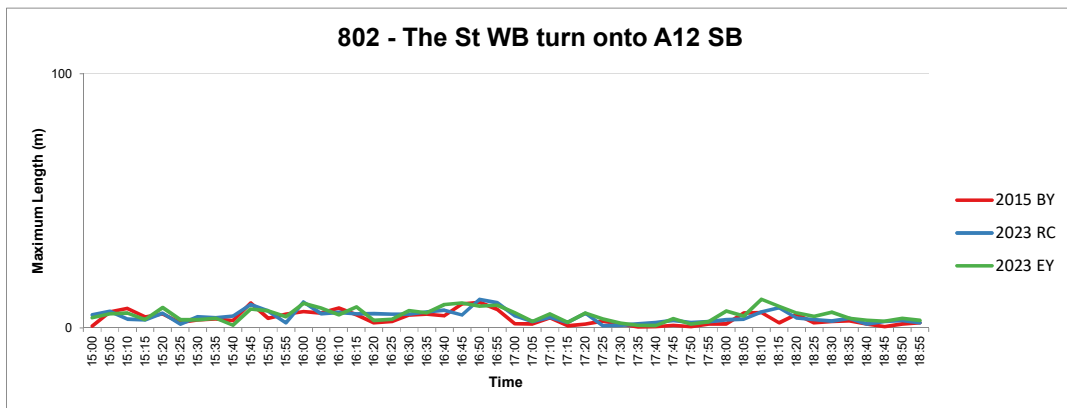
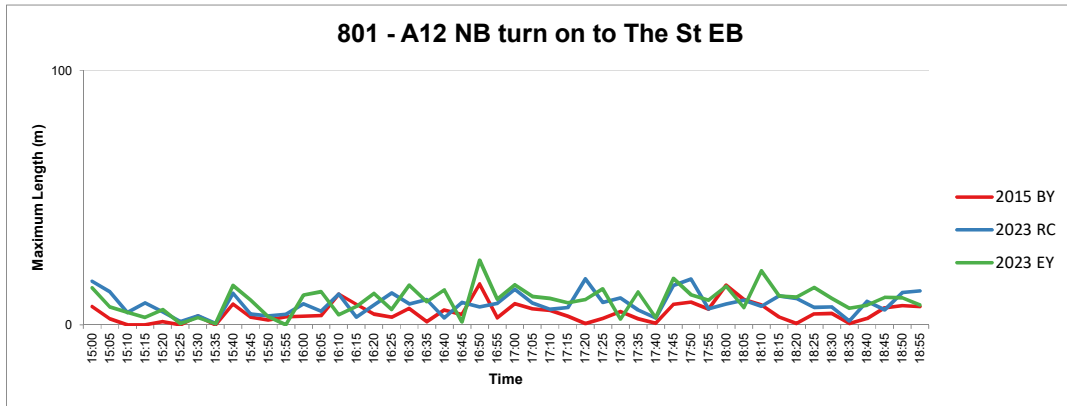

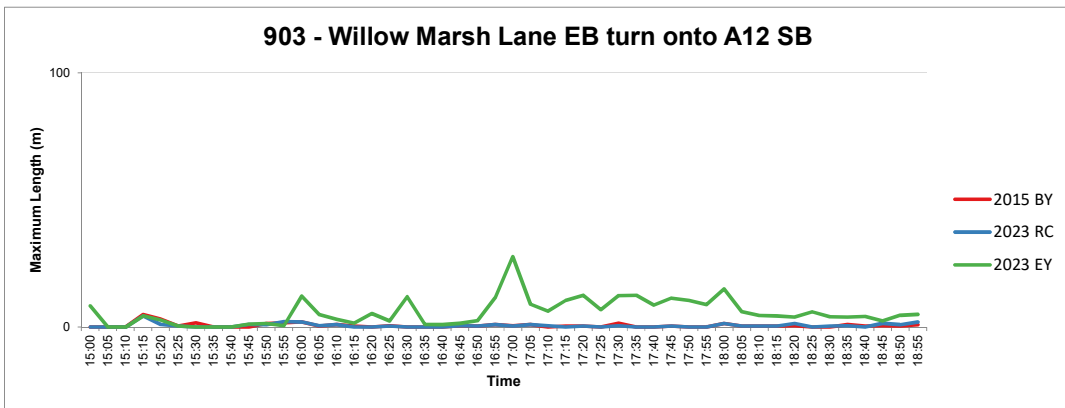
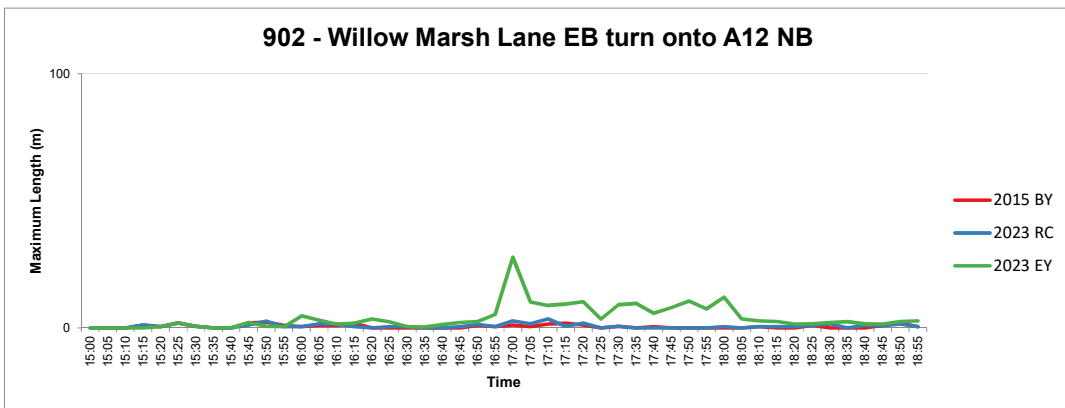
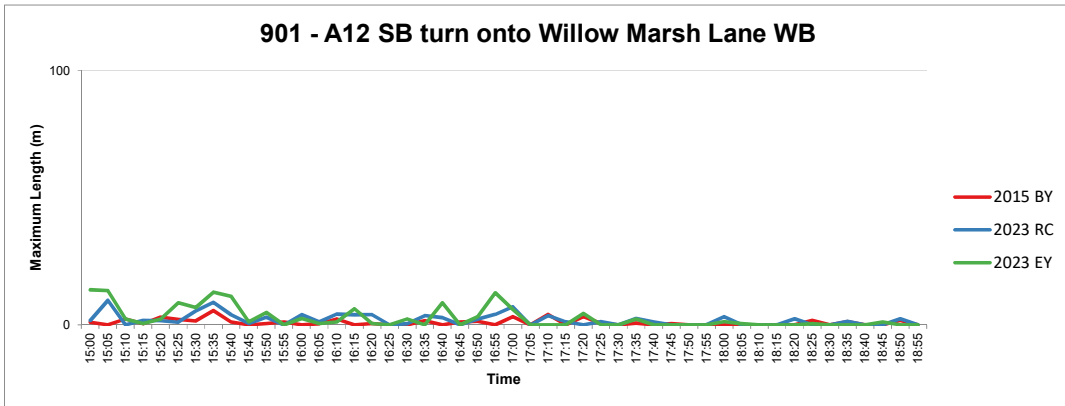

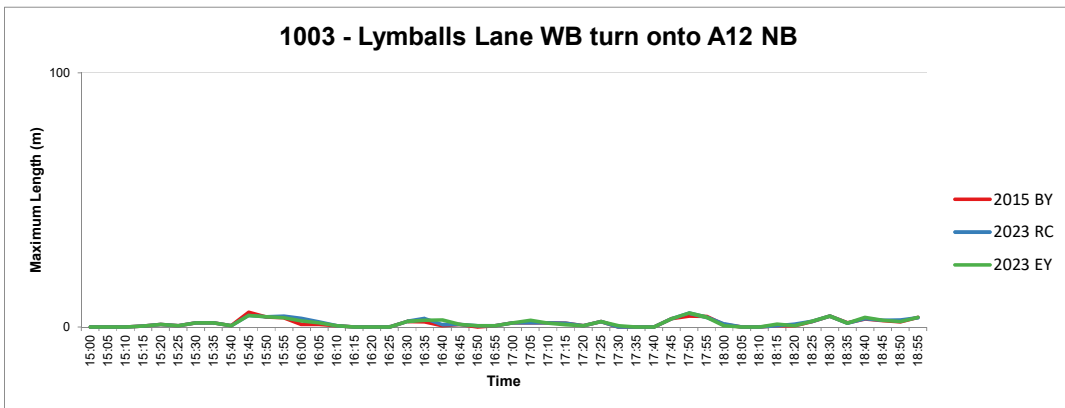
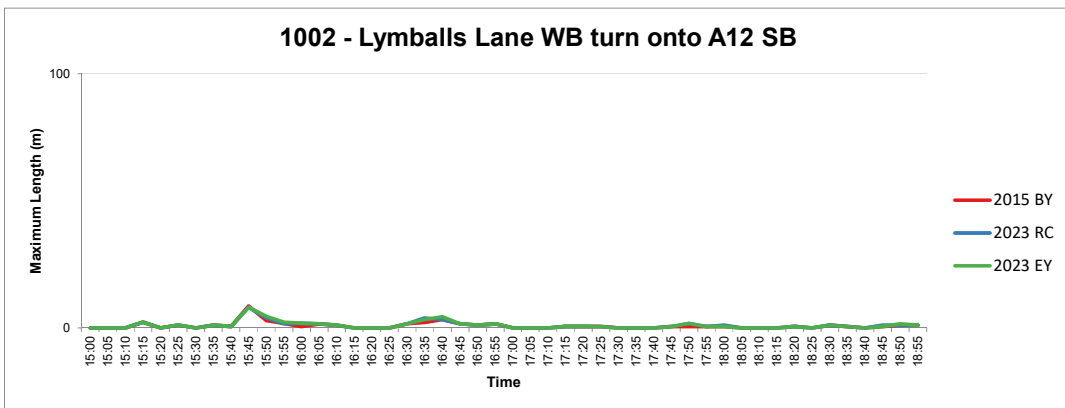
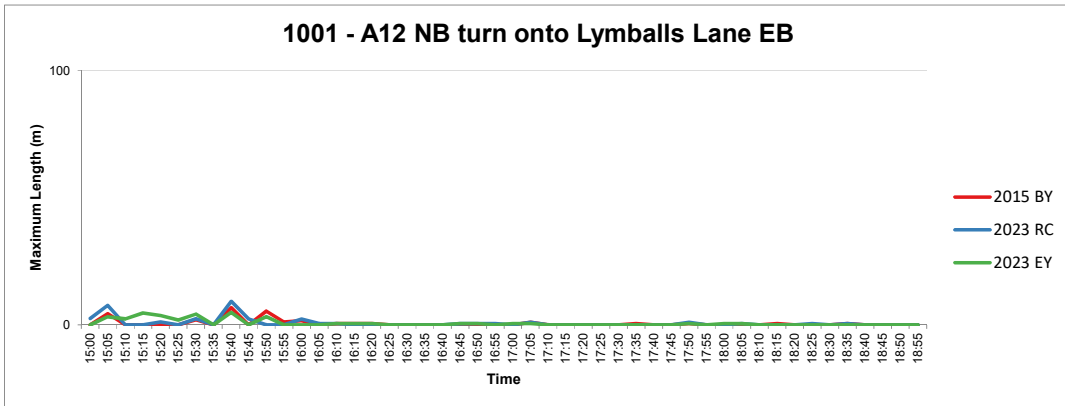

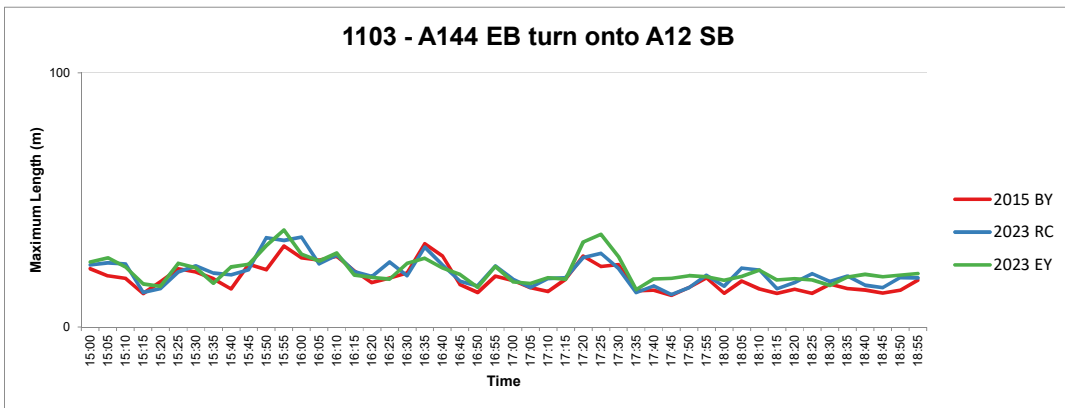
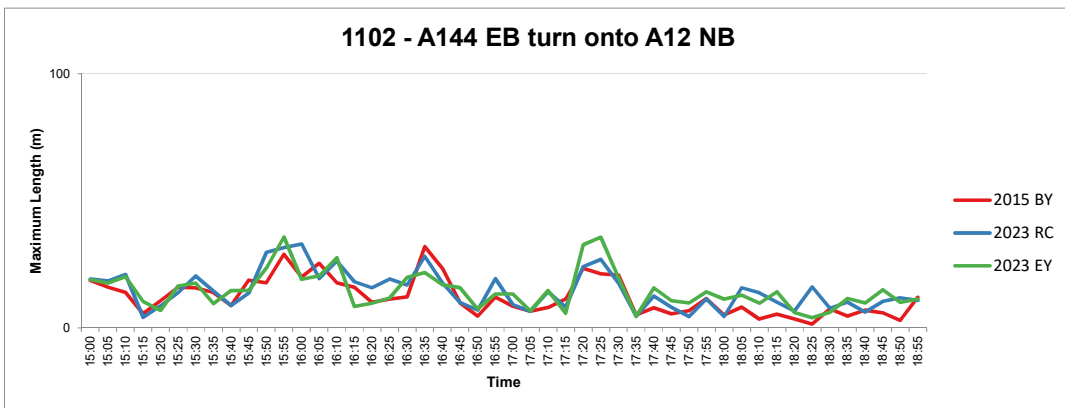
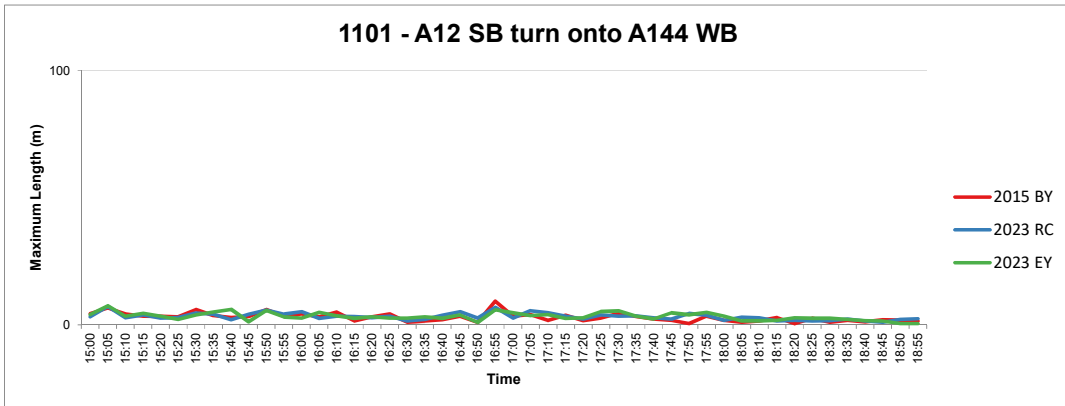

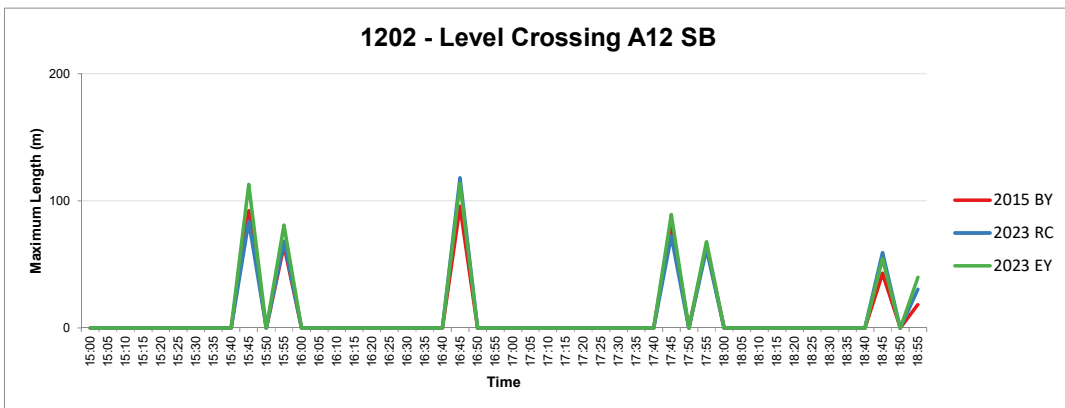
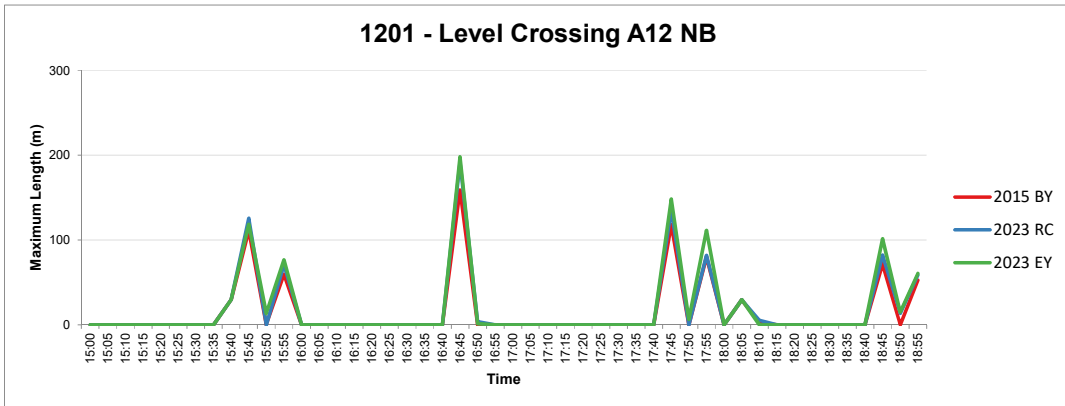

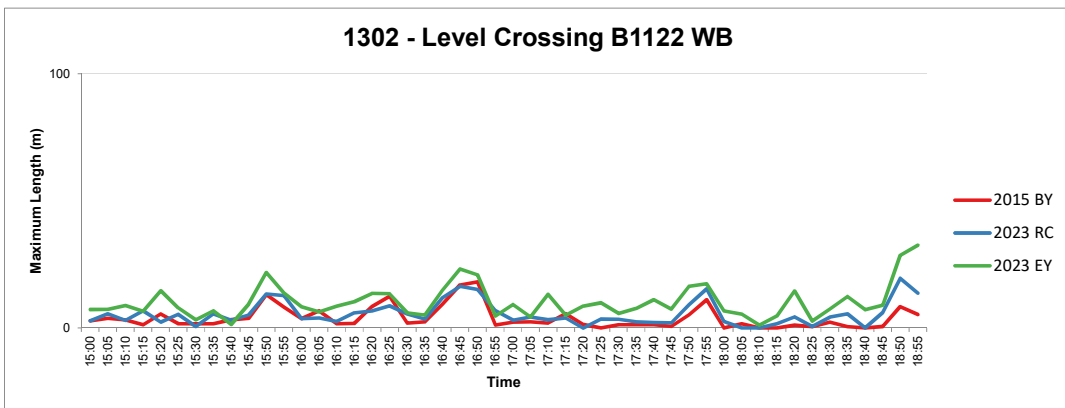
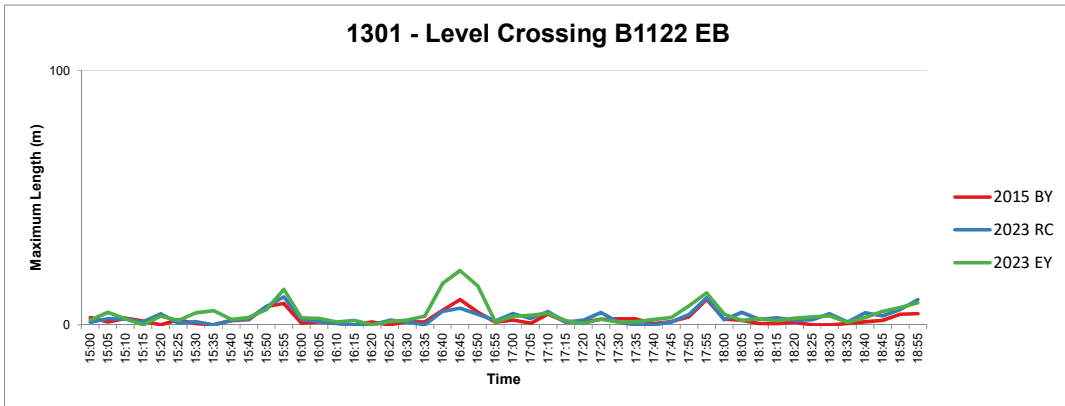

Appendix D

2028 FORECAST MODEL RESULTS





	2015 BY (AM)	2028 RC (AM)	2028 PC (AM)	2015 BY (PM)	2028 RC (PM)	2028 PC (PM)
Total Time Taken (s)	989514	1204515	1412992	1797945	2097607	2324954
Total Distance (m)	17192684	20645097	23777305	31020763	35642309	38886653
Total Vehicles	3124	3745	4446	5858	6764	7452
Total Delay (s)	87147	115966	157343	166614	213797	255842
Average Time (s) / Vehicle	317	322	318	307	310	312
Average Time (s) / Mile	93	94	96	93	95	96
Average Distance (m) / Vehicle	5504	5513	5348	5295	5269	5218
Average Speed (mph)	39	38	38	39	38	37
Average Speed (kph)	63	62	61	62	61	60
Average Delay / Vehicle	28	31	35	28	32	34

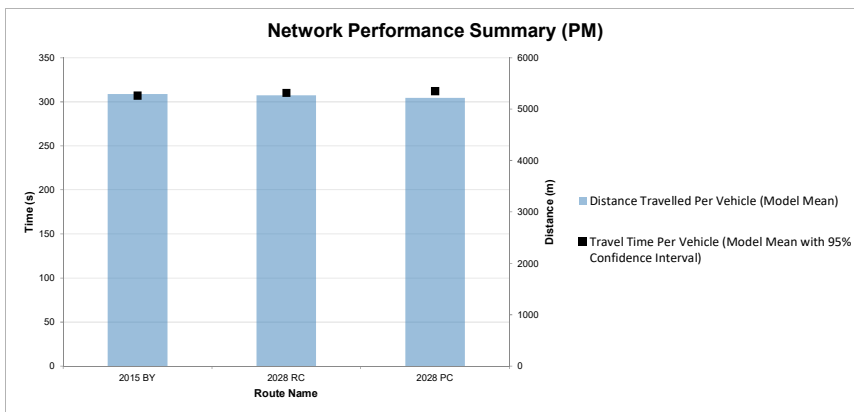
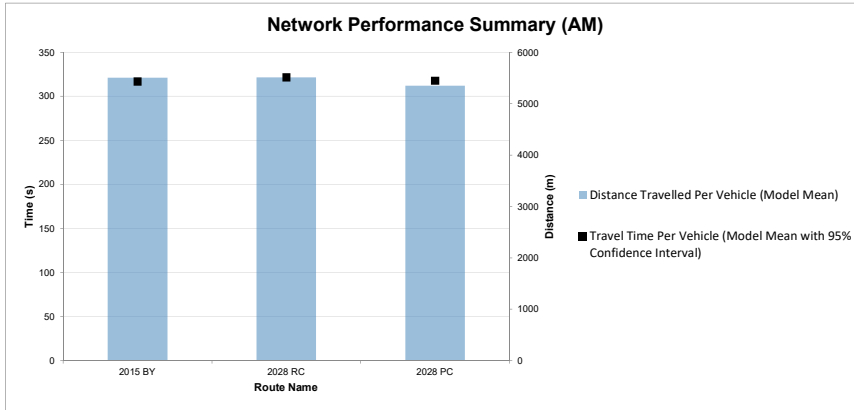

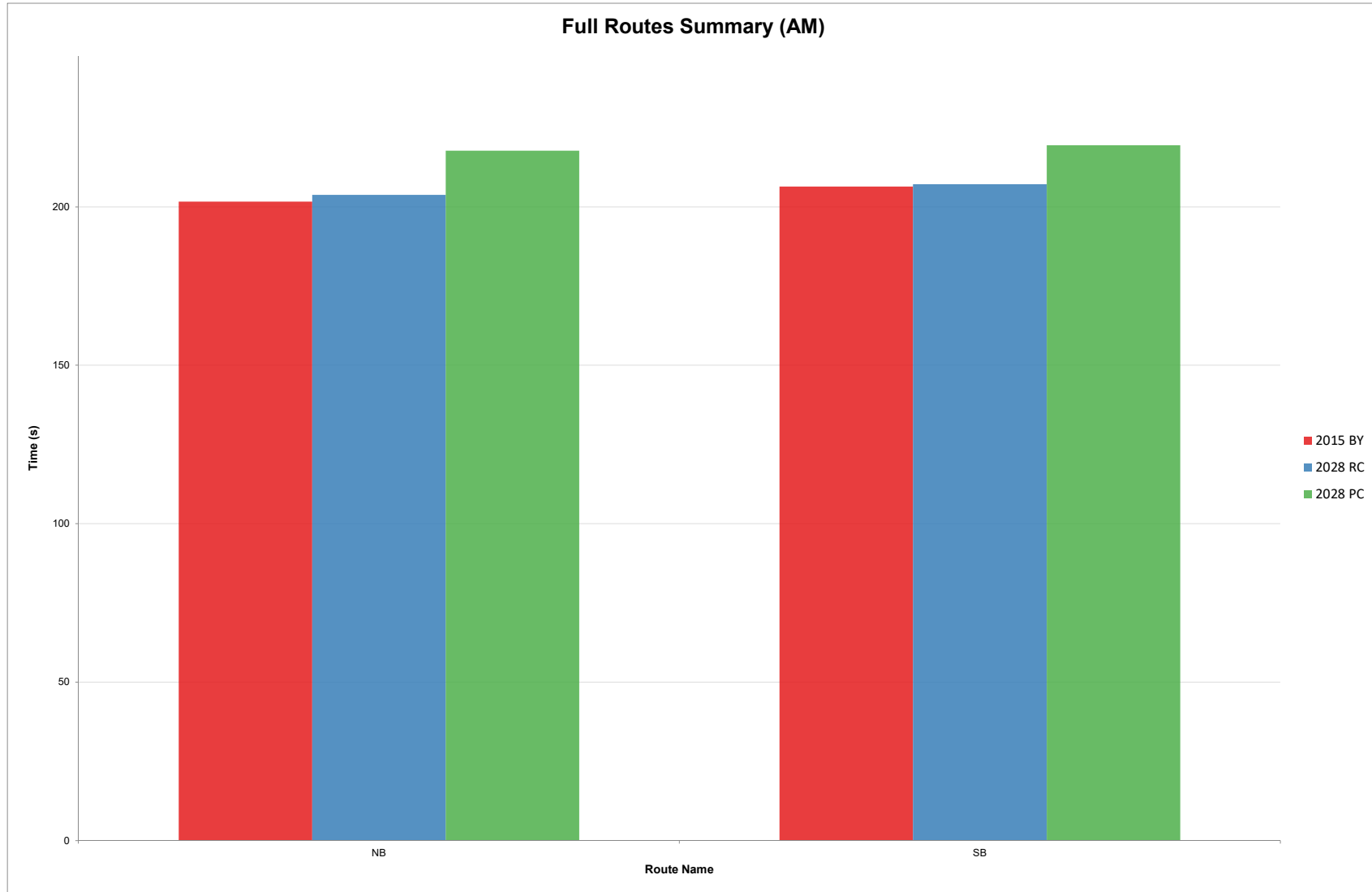

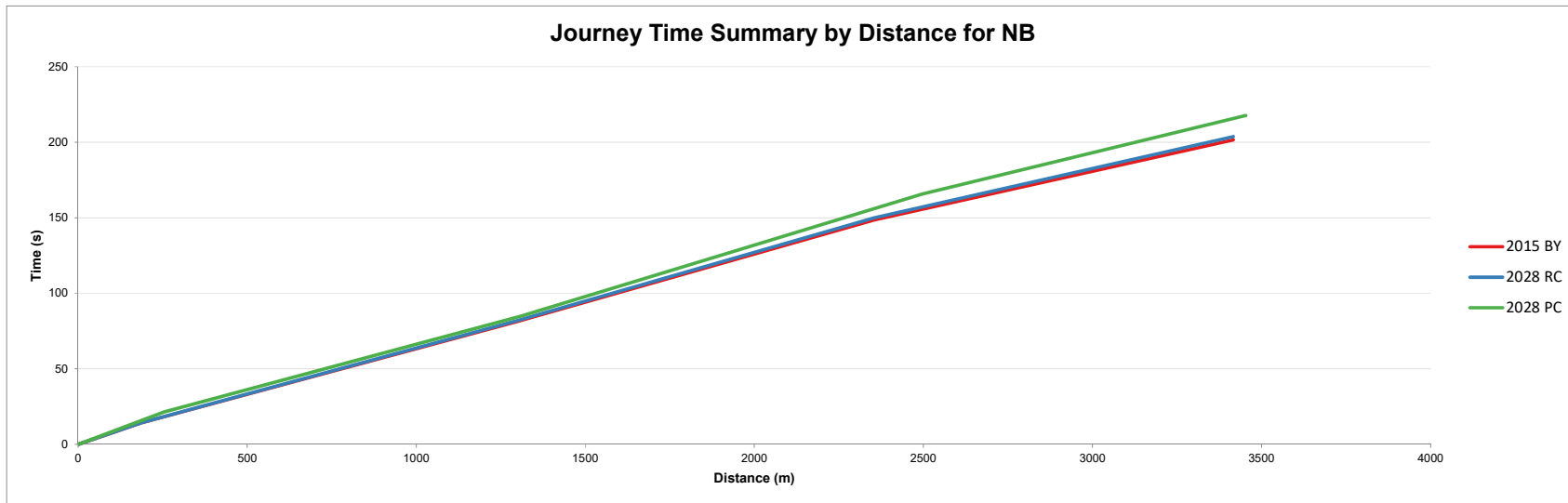
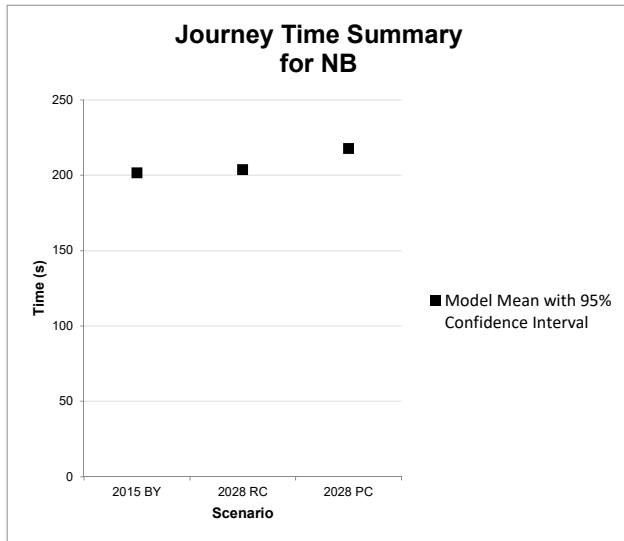

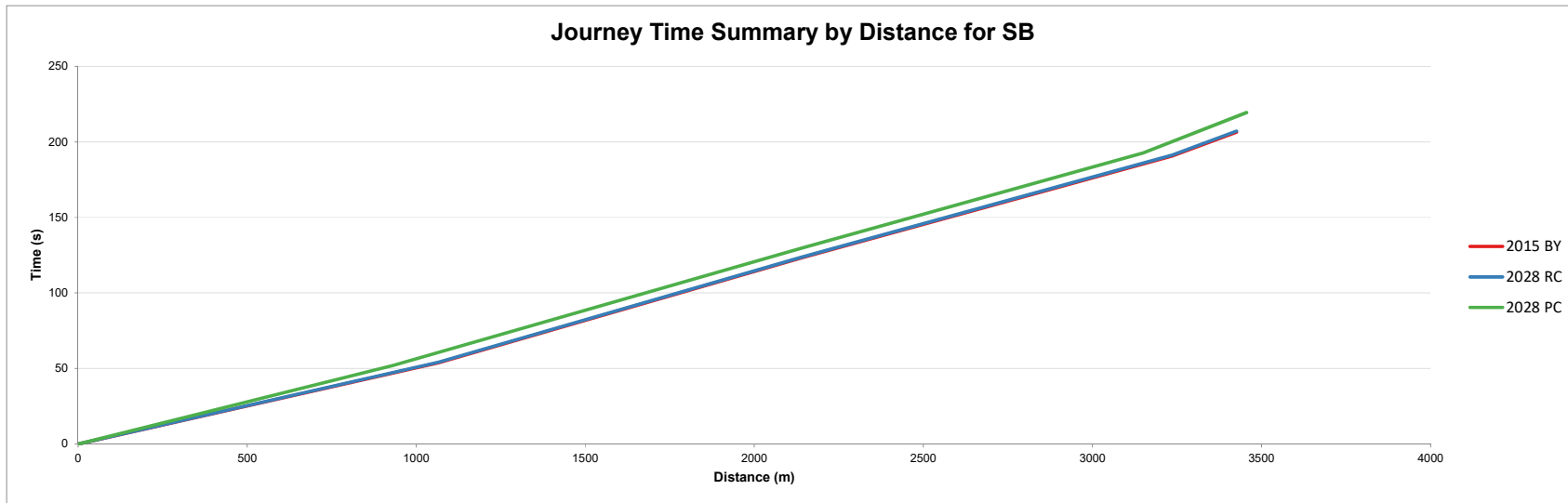
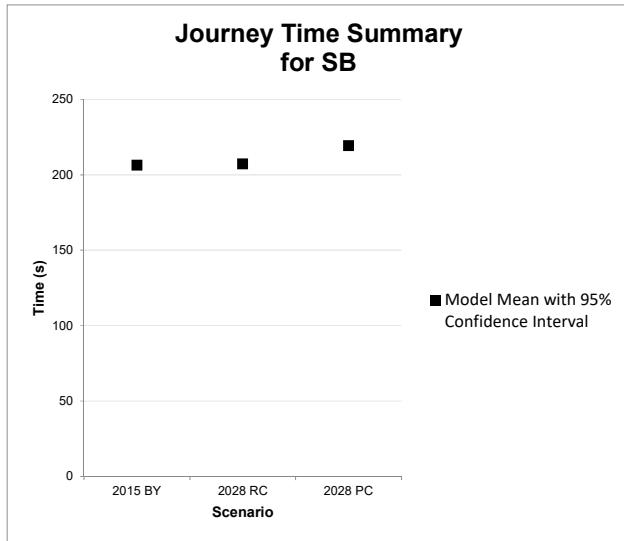

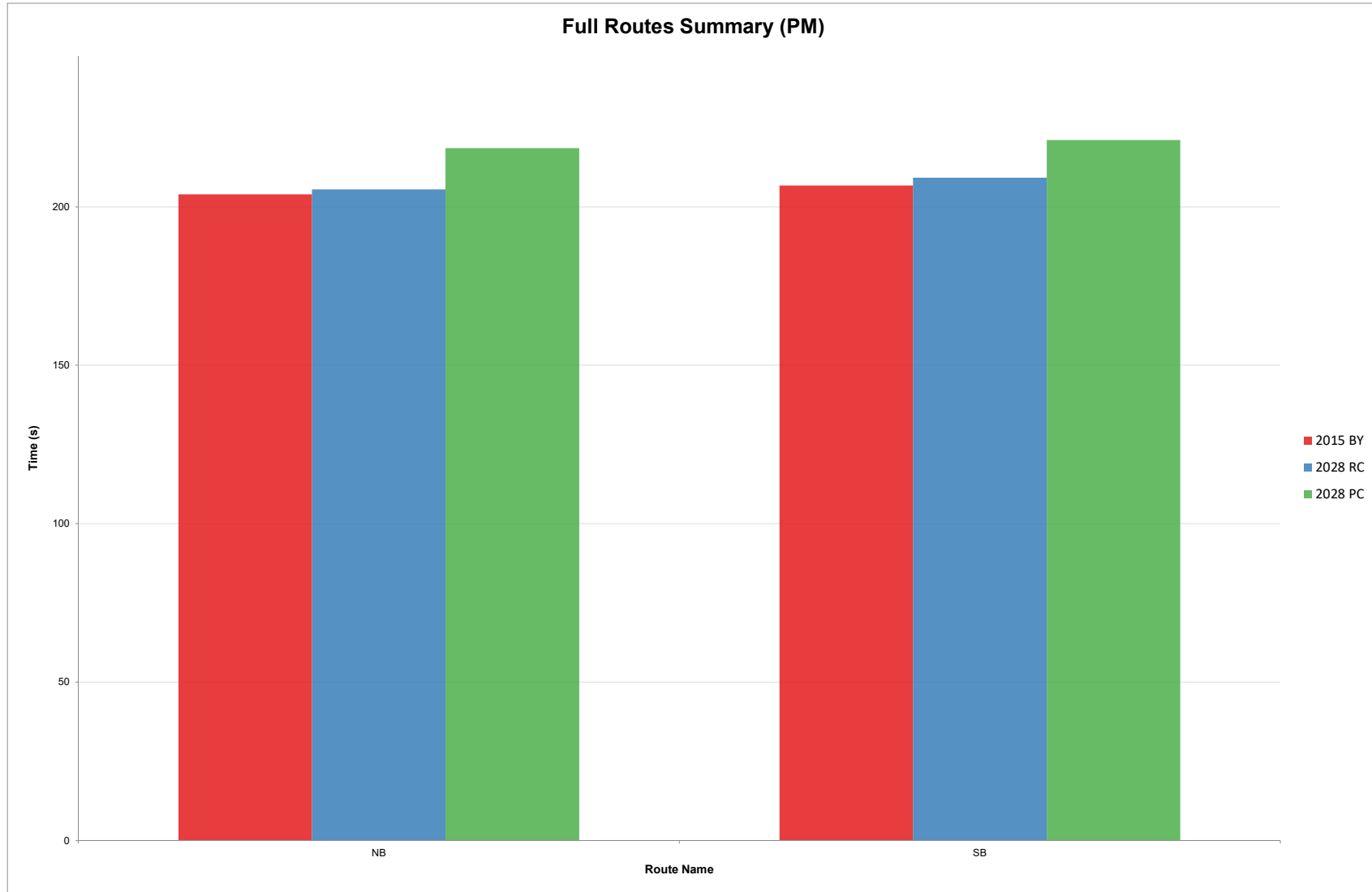

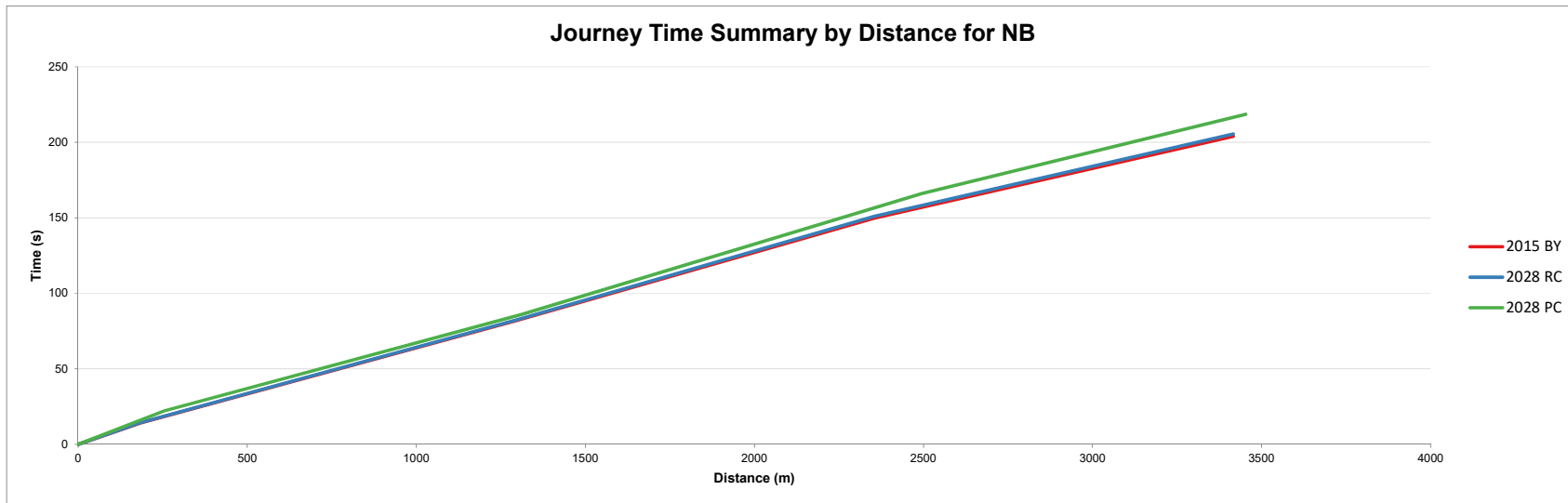
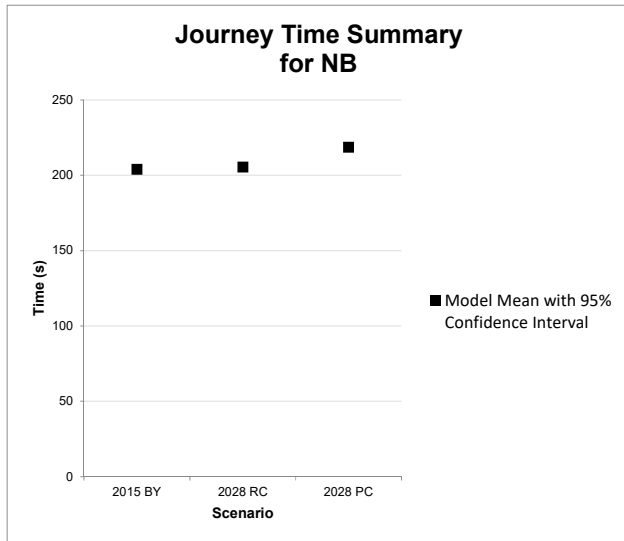



**Journey Time Summary
for SB**

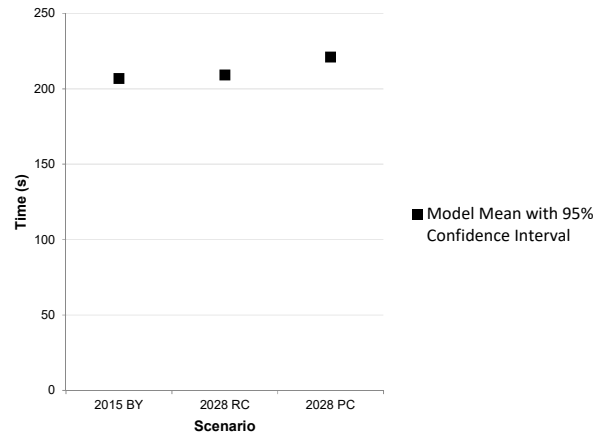

Journey Time Summary by Distance for SB

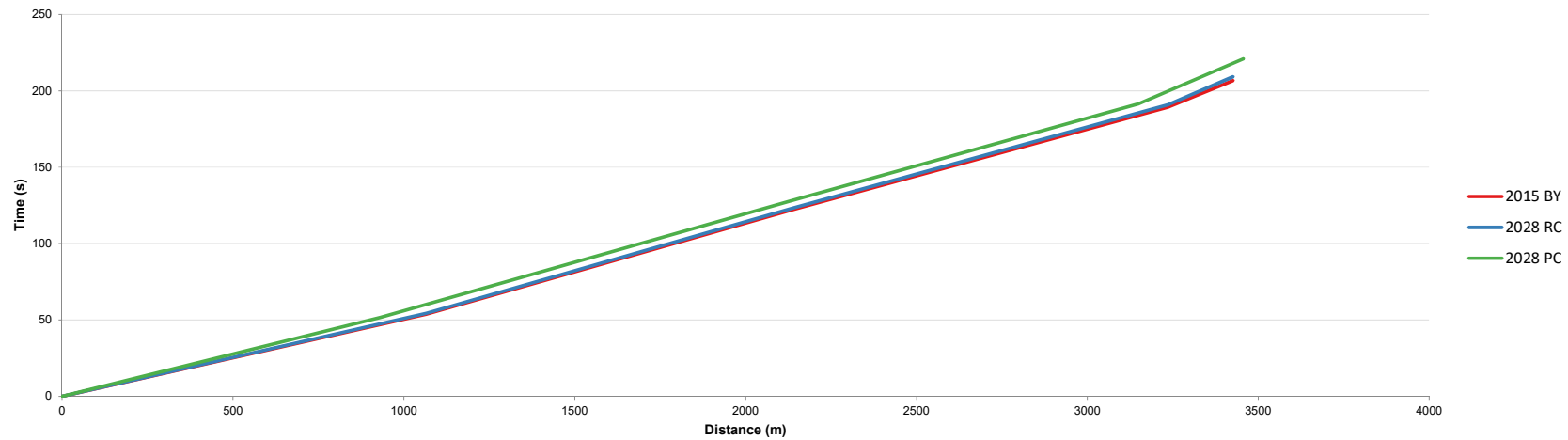



Journey Time Table
AM
2028

Route Names	2015 BY	2028 RC	2028 PC
1 - Section 1 NB	14	14	21
2 - Section 2 NB	67	68	63
3 - Section 3 NB	67	68	81
4 - Section 4 NB	53	54	52
NB	202	204	218
5 - Section 1 SB	54	54	52
6 - Section 2 SB	70	70	78
7 - Section 3 SB	67	68	63
8 - Section 4 SB	16	16	27
SB	206	207	219



Journey Time Table
PM
2028

Route Names	2015 BY	2028 RC	2028 PC
1 - Section 1 NB	14	14	22
2 - Section 2 NB	68	68	64
3 - Section 3 NB	68	68	80
4 - Section 4 NB	54	55	52
NB	204	205	219
5 - Section 1 SB	54	54	52
6 - Section 2 SB	69	69	77
7 - Section 3 SB	67	67	63
8 - Section 4 SB	17	18	29
SB	207	209	221



Queue Comparison
AM
Maximum Length Summary
Maximum Length (m)

	2015 BY	2028 RC	2028 PC
301 - A12 NB turn onto High Street	0.0	1.7	1.1
302 - A12 SB turn onto High Street	37.2	51.3	34.7
303 - High Street(A1120) EB turn	16.0	19.7	23.1
304 - High Street(A1120) EB turn	7.8	11.2	10.5
401 - A12 NB turn onto B1122 EB	12.0	15.1	16.8
402 - B1122 WB turn onto A12 SB	16.1	31.1	15.0
403 - B1122 WB turn onto A12 NB	16.2	29.6	15.4
404 - A12 SB turn onto B1122 EB	0.0	0.0	32.9
501 - A12 NB turn onto Westleton Road	8.6	7.0	10.7
502 - Westleton Road WB turn onto A12 NB	5.7	7.1	6.2
503 - Westleton Road WB turn onto A12 SB	3.6	6.5	6.0
601 - Darsham Petrol Station turn	11.9	11.9	13.2
602 - Darsham Petrol Station turn	12.4	11.6	14.6
701 - A12 NB turn in to Darsham Lane	27.8	37.7	76.9
801 - A12 NB turn on to The Street	14.4	20.2	30.4
802 - The Street WB turn onto A12 SB	6.6	6.1	7.1
803 - The Street WB turn onto A12 NB	8.8	8.3	8.1
901 - A12 SB turn onto Willow Marsh Lane	4.2	8.8	
902 - Willow Marsh Lane EB turn	3.3	3.1	
903 - Willow Marsh Lane EB turn	4.8	7.4	
1001 - A12 NB turn onto Lymballs Lane	3.6	1.6	12.4
1002 - Lymballs Lane WB turn onto A12 NB	5.2	4.1	4.1
1003 - Lymballs Lane WB turn onto A12 SB	3.7	6.1	3.9
1101 - A12 SB turn onto A144 WB	6.9	7.1	3.8
1102 - A144 EB turn onto A12 NB	61.7	73.3	83.6
1103 - A144 EB turn onto A12 SB	62.0	73.3	82.3
1104 - A12 SB turn onto A144 WB B first queue			11.7
1201 - Level Crossing A12 NB	107.8	139.5	134.6
1202 - Level Crossing A12 SB	161.3	160.5	198.0
1301 - Level Crossing B1122 EB	22.0	23.7	21.9
1302 - Level Crossing B1122 WB	6.9	10.0	12.3
1401 - PandR Roundabout A12 NB			35.3
1402 - PandR Roundabout PandR Access			6.1
1403 - PandR Roundabout A12 SB			33.6
904 - PandR Access SB turn onto Willow Marsh Lane			0.5
905 - Willow Marsh Lane EB turn onto PandR Access			0.7
906 - Willow Marsh Lane EB turn onto PandR Access			0.0

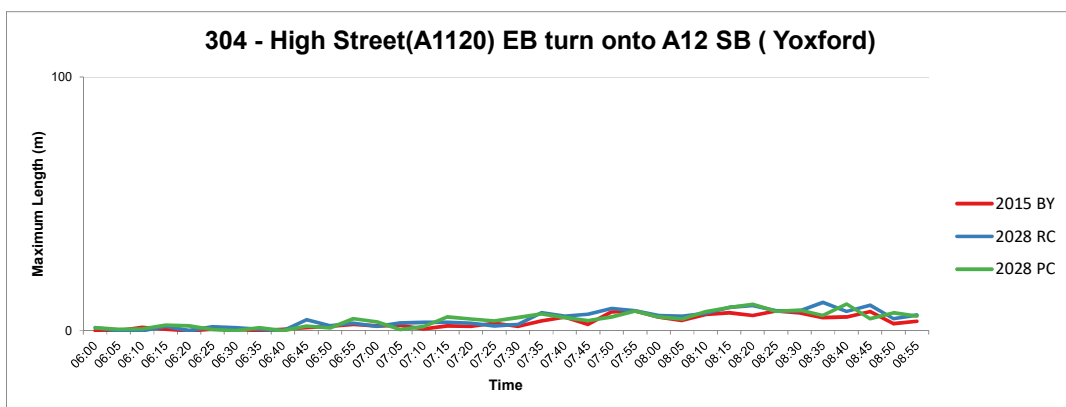
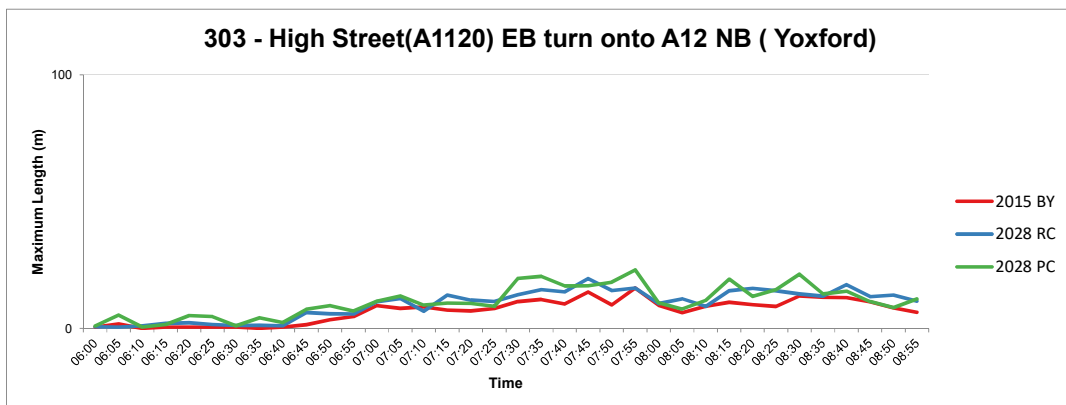
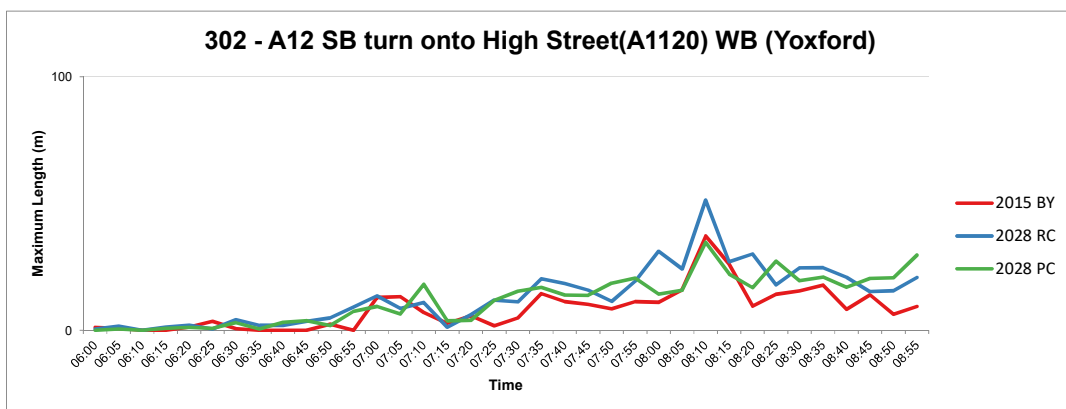
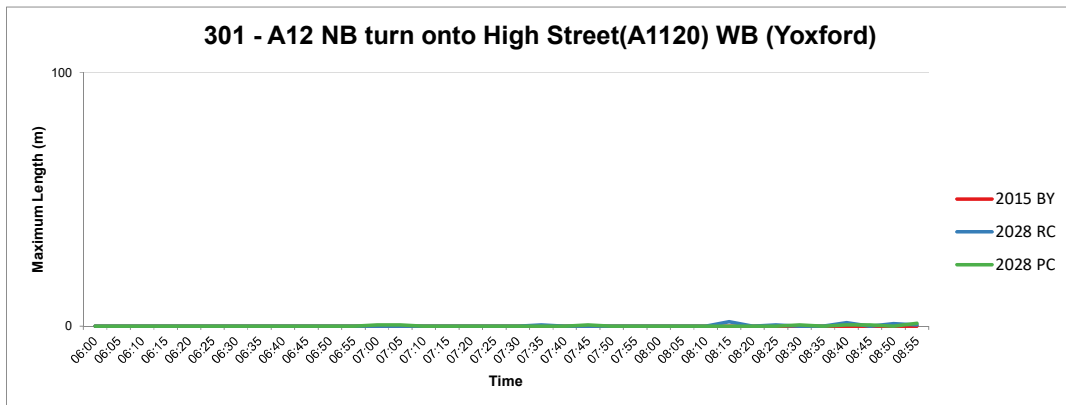

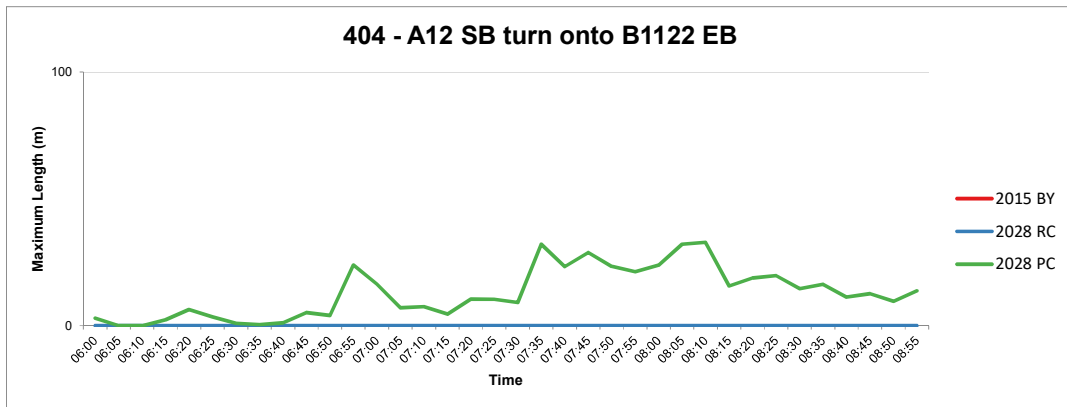
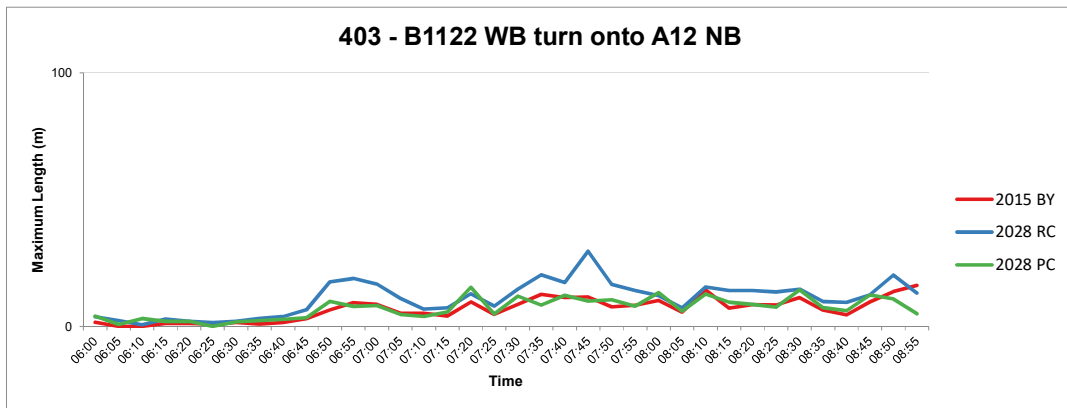
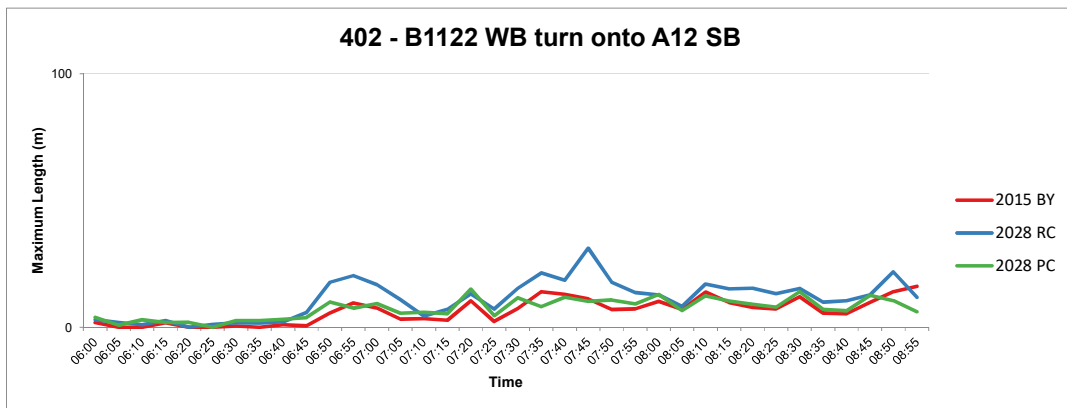
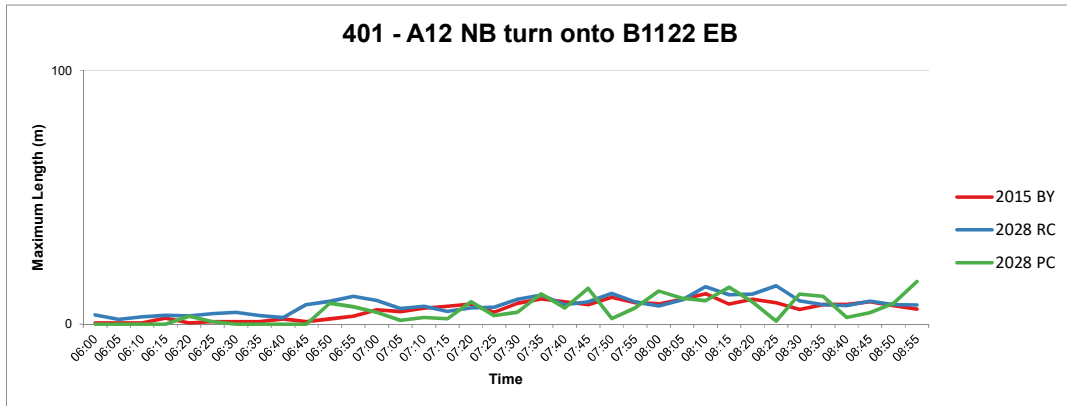

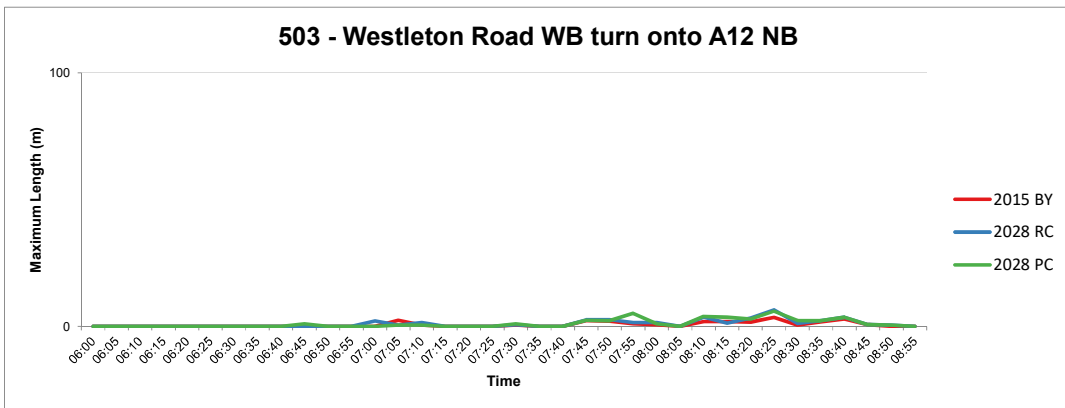
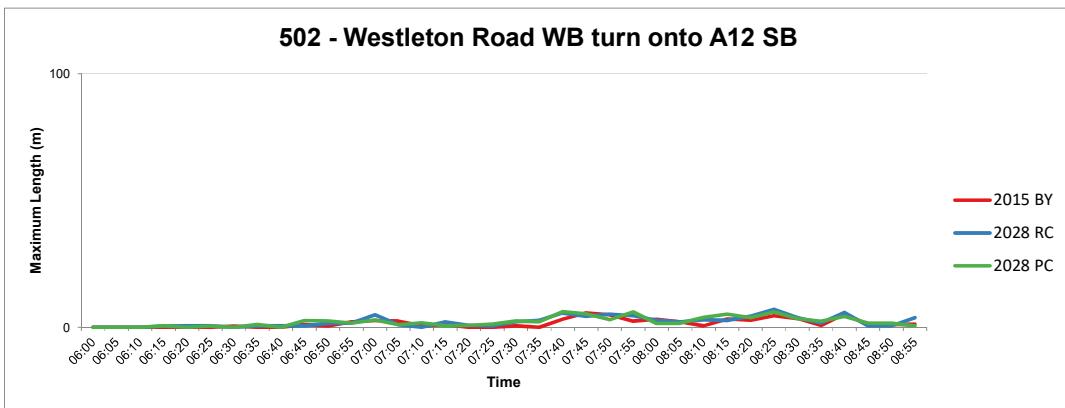
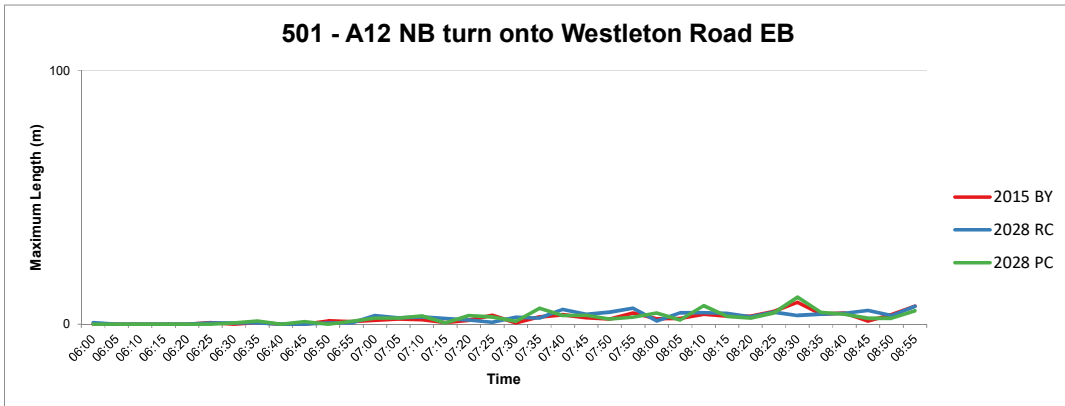

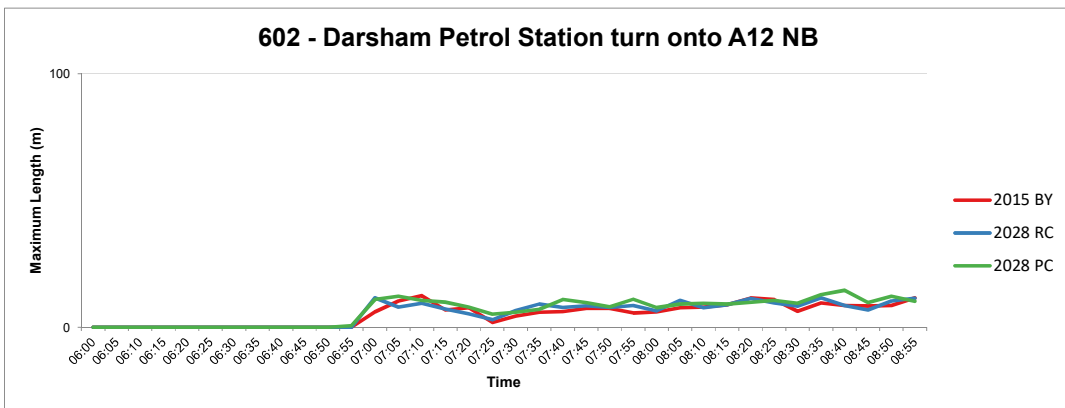
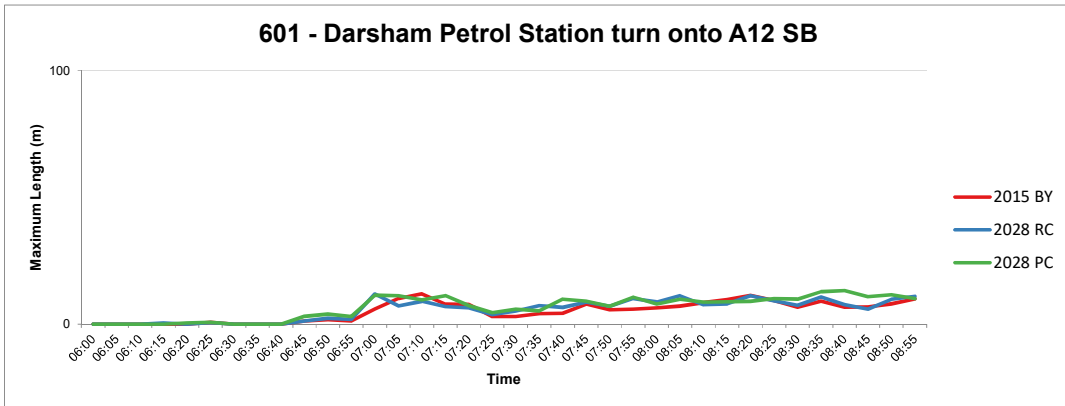

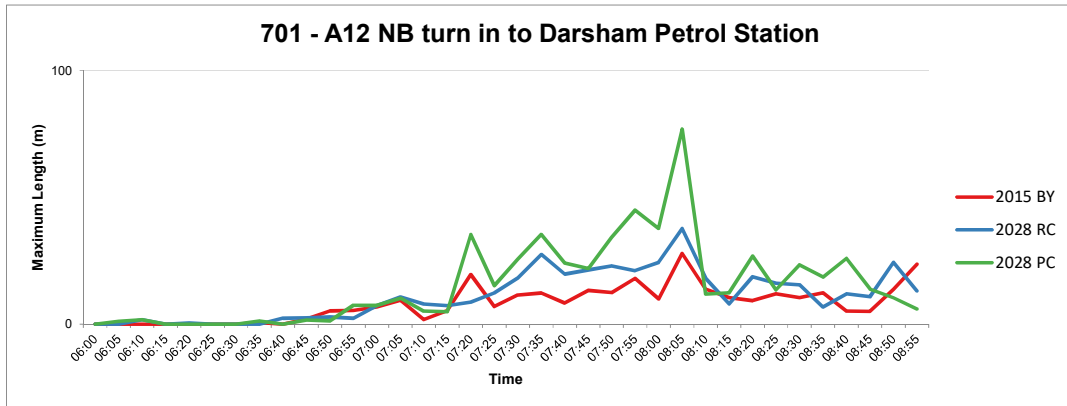

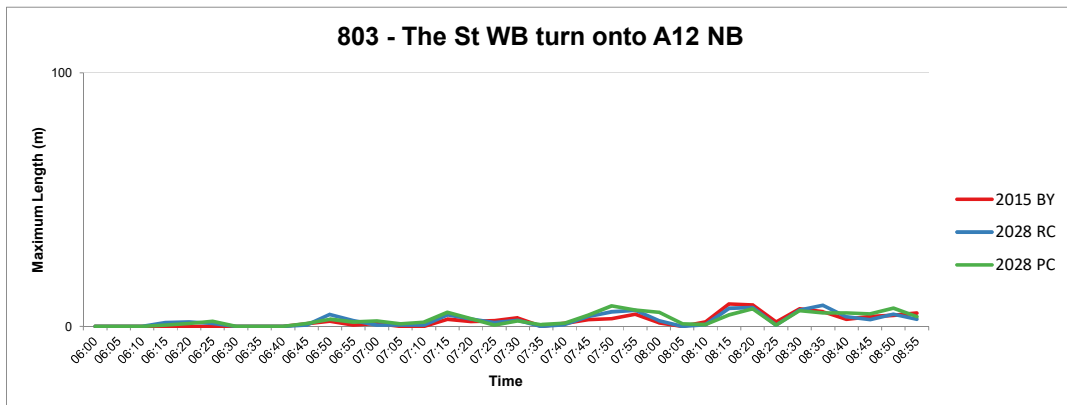
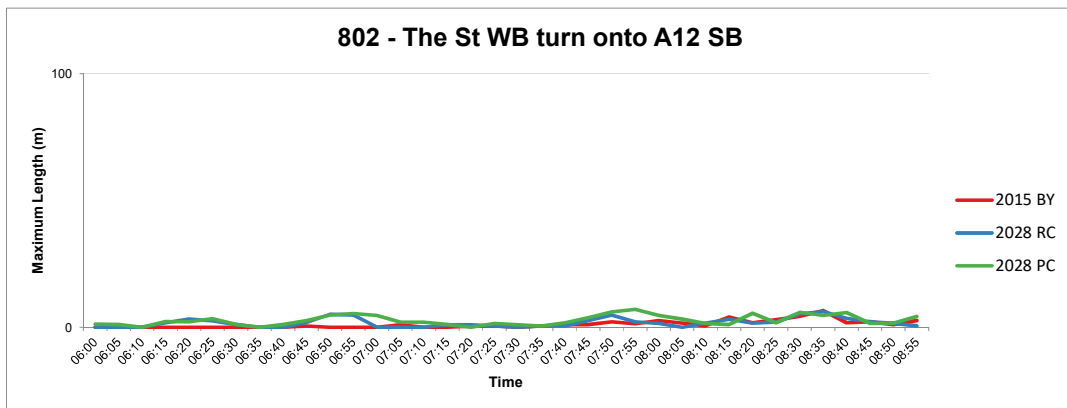
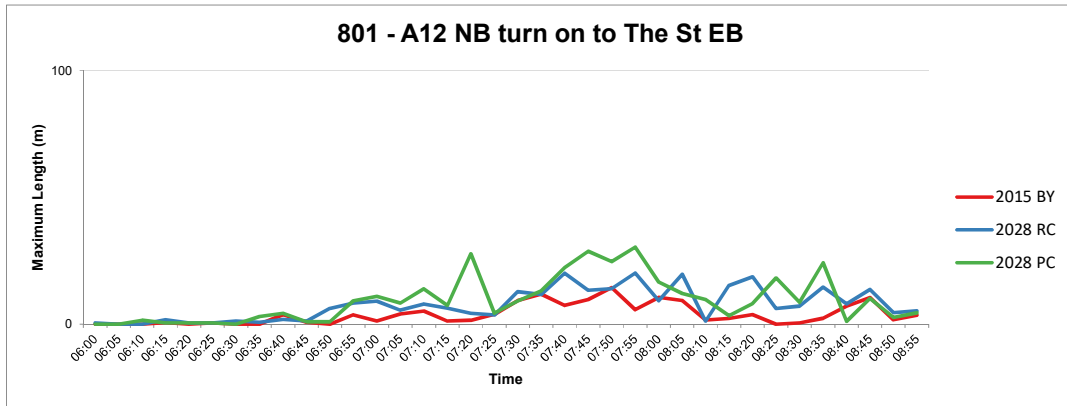

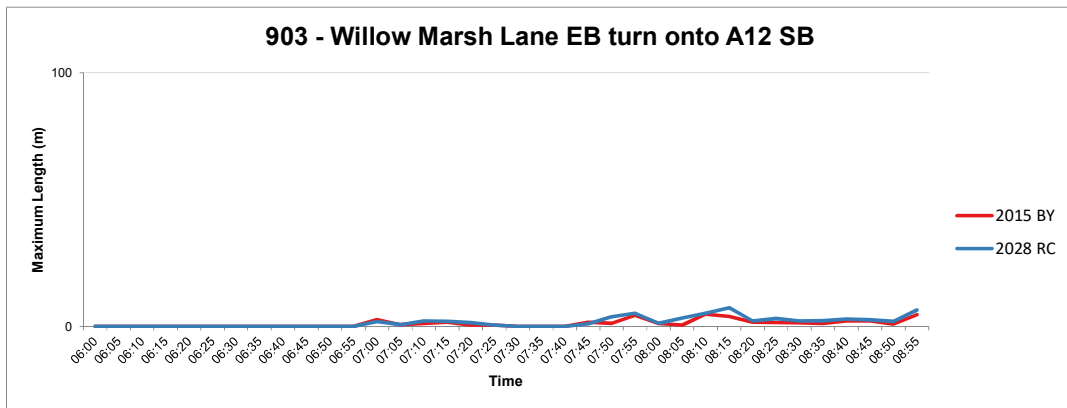
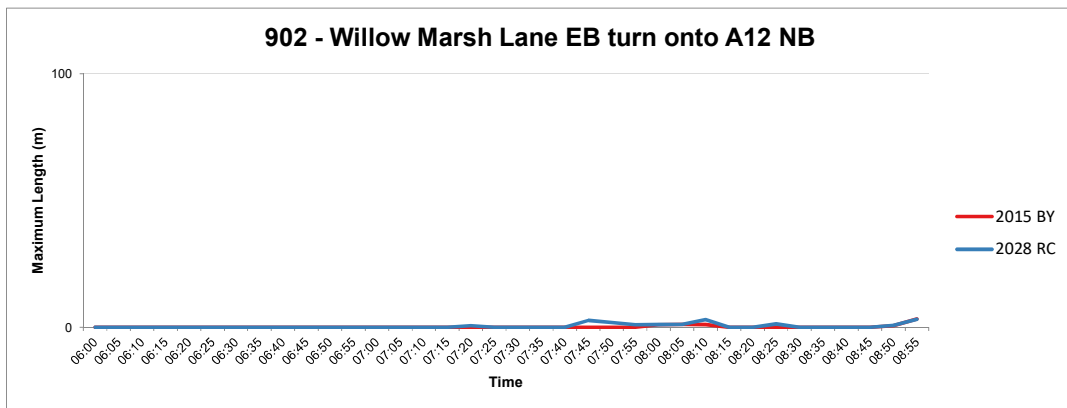
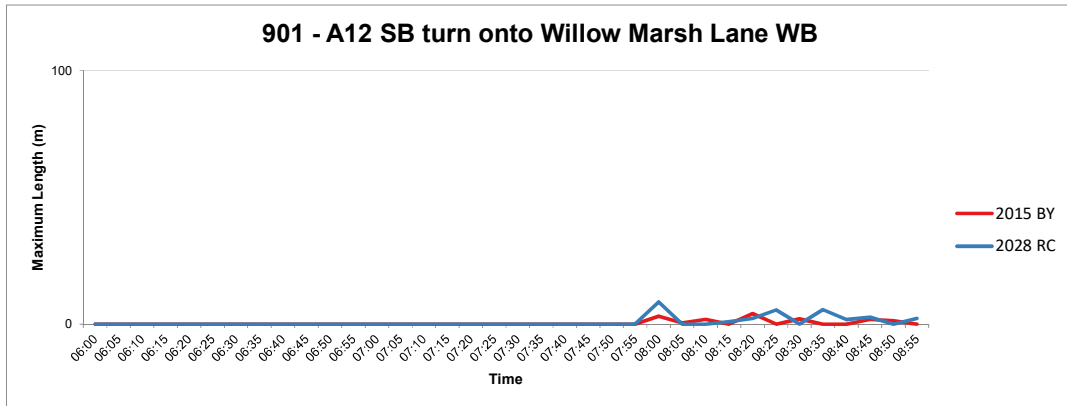

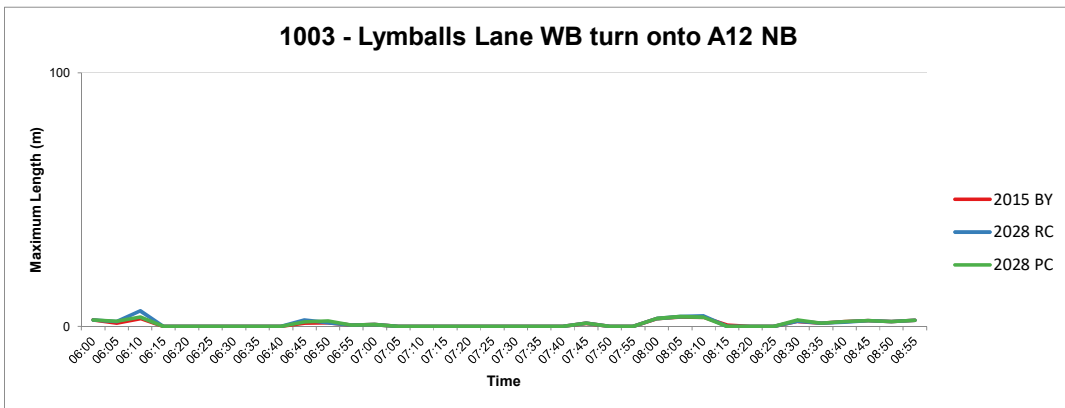
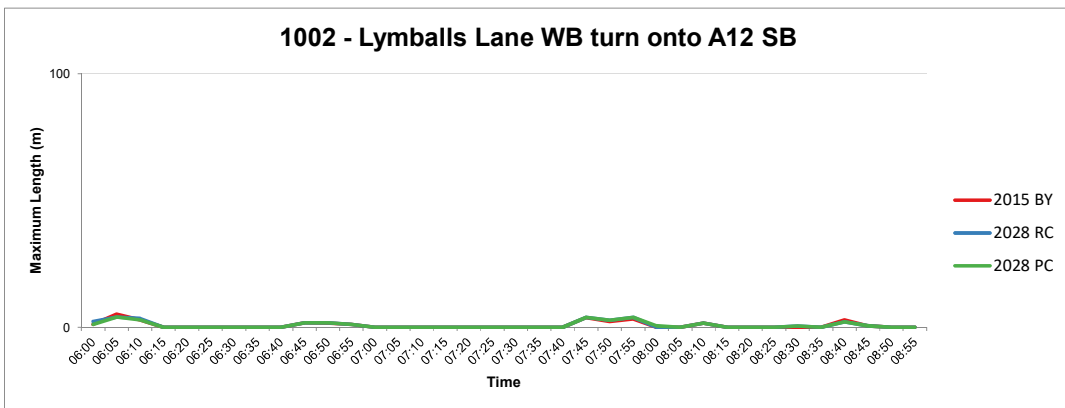
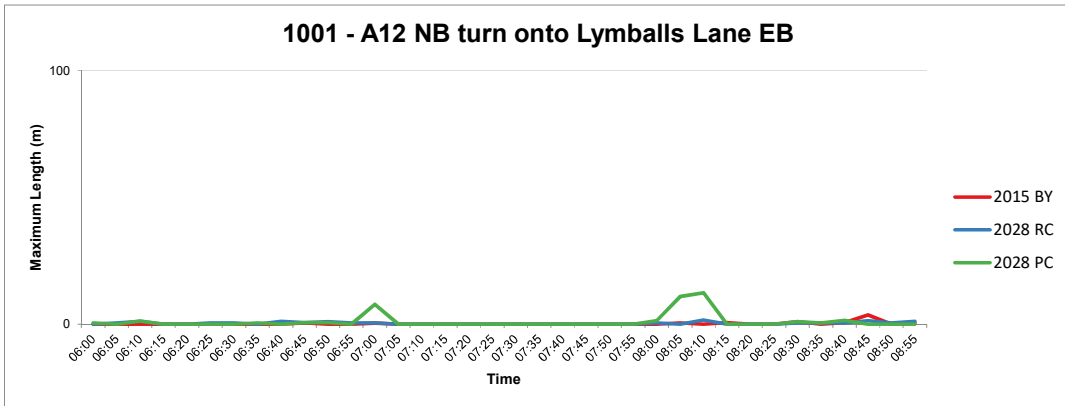

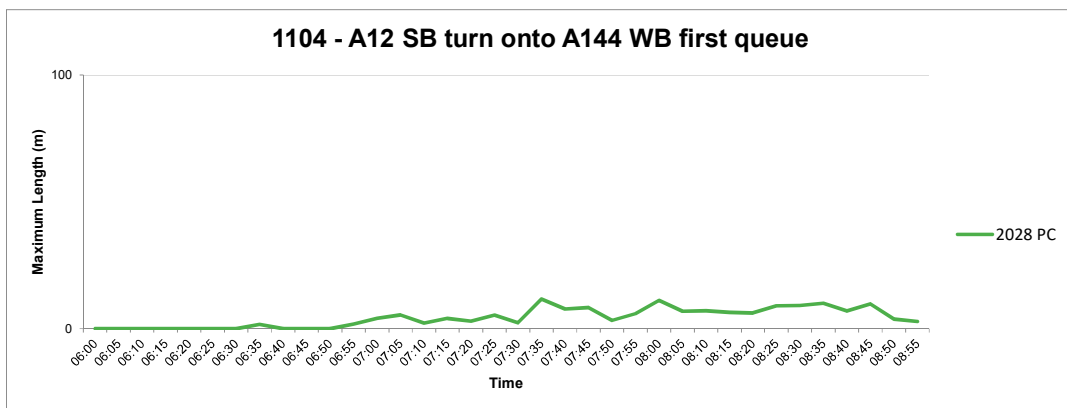
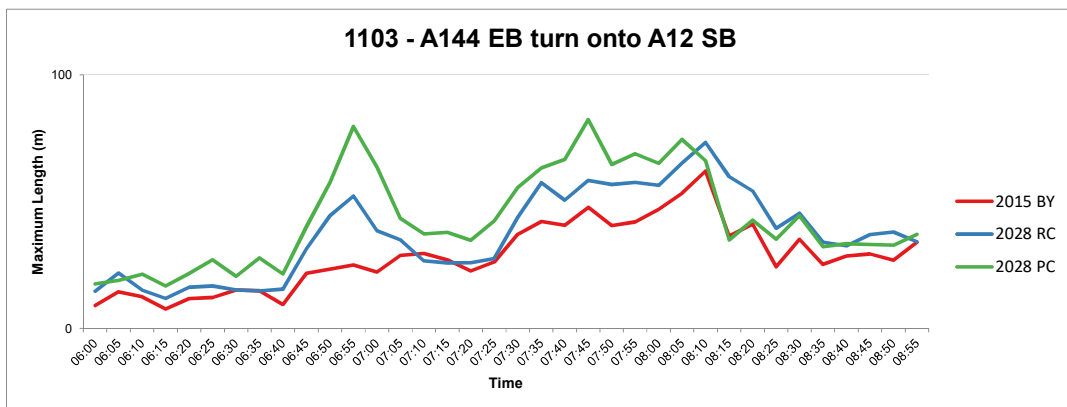
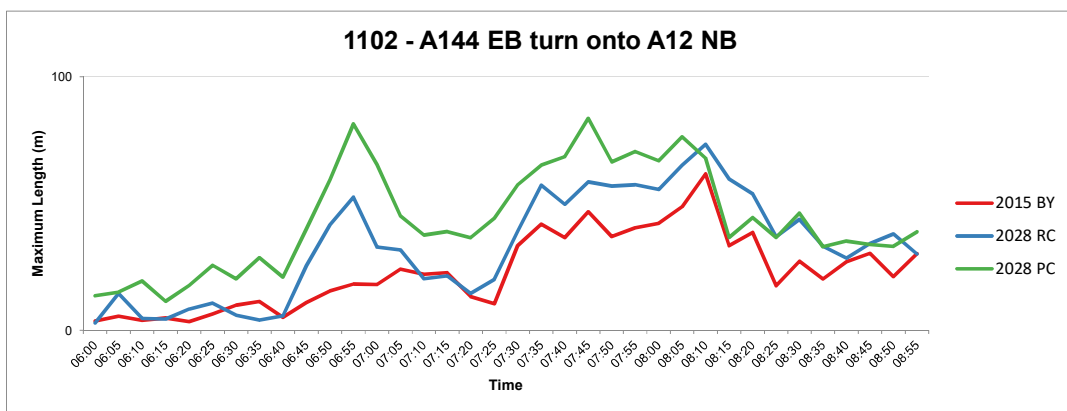
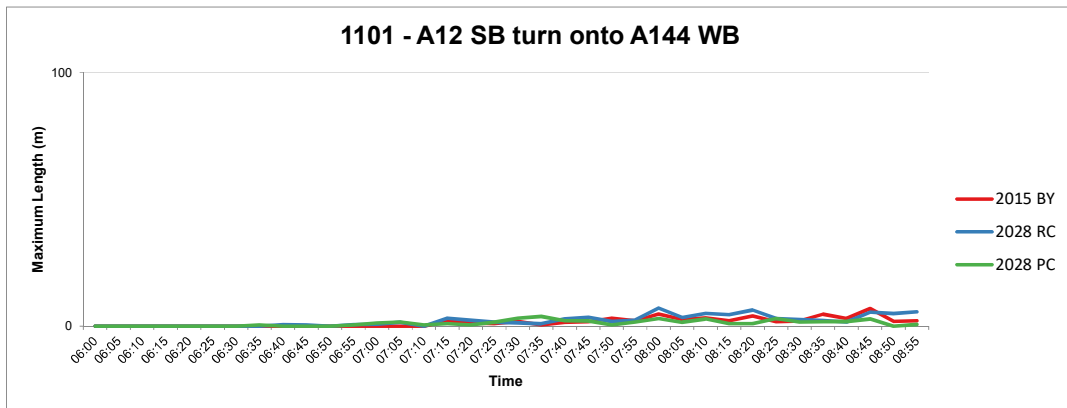

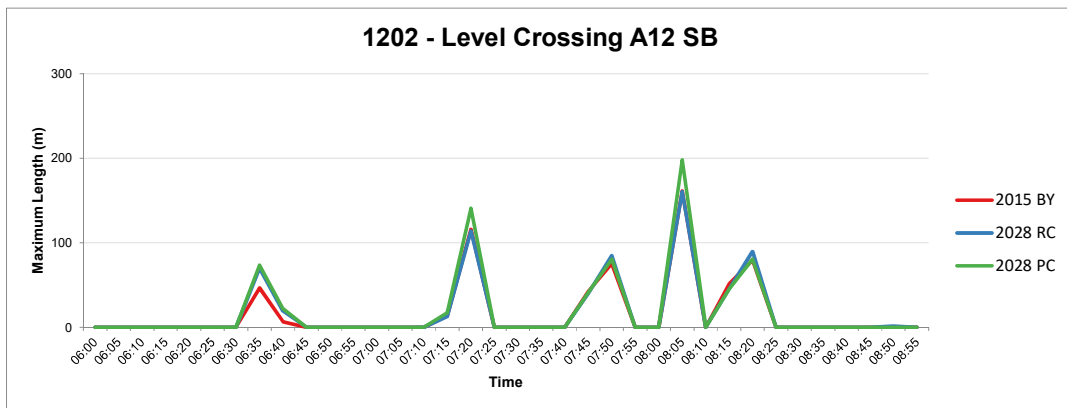
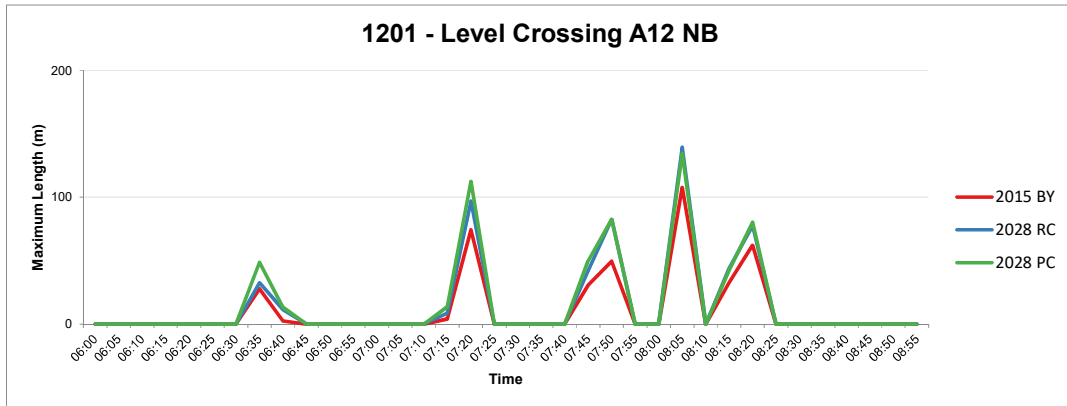

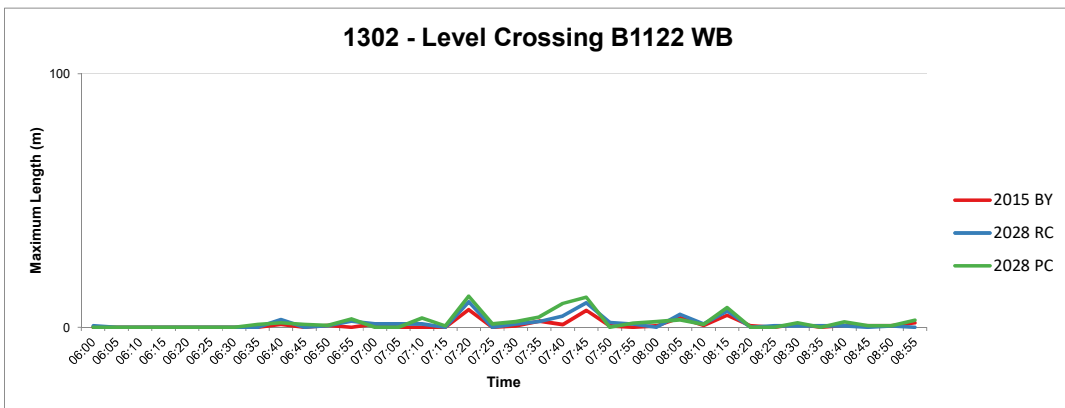
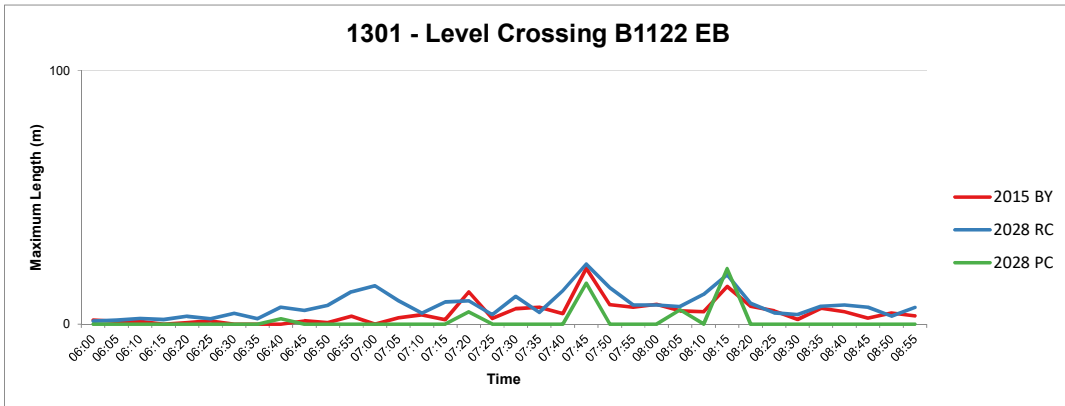

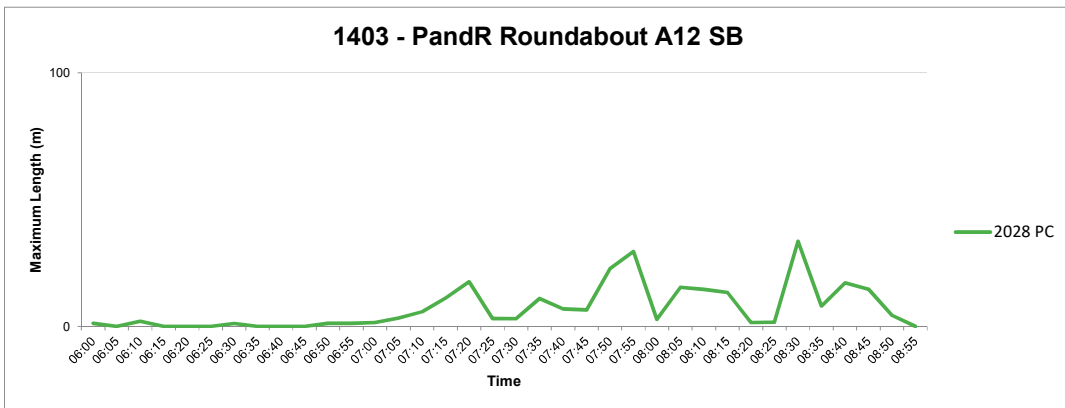
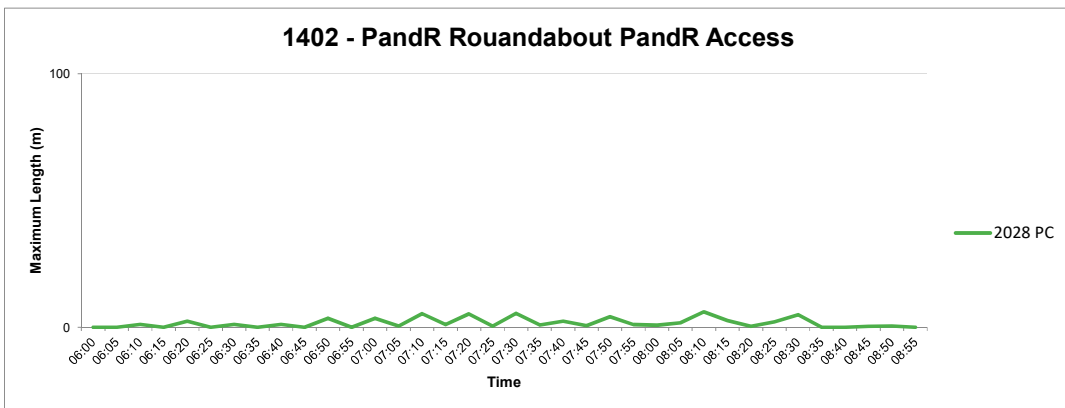
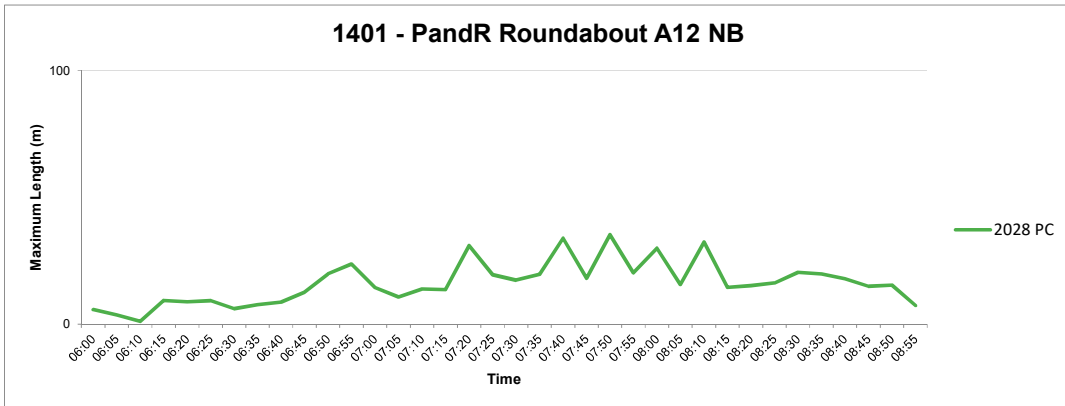

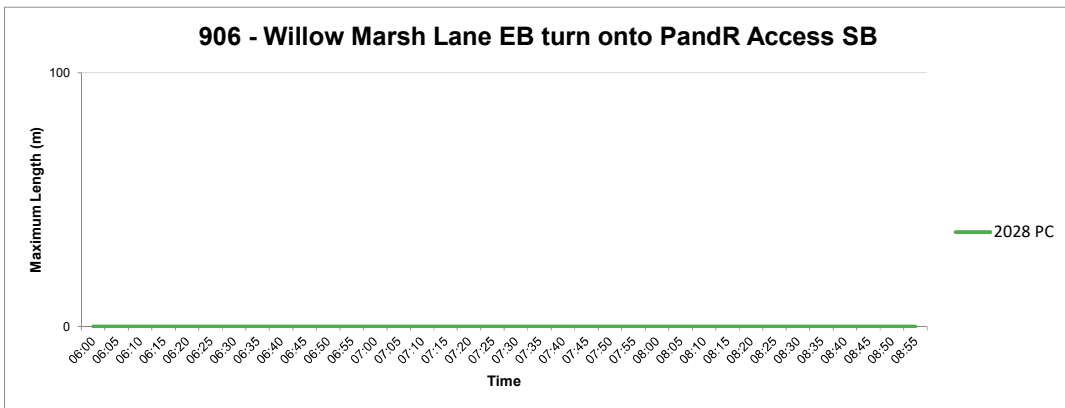
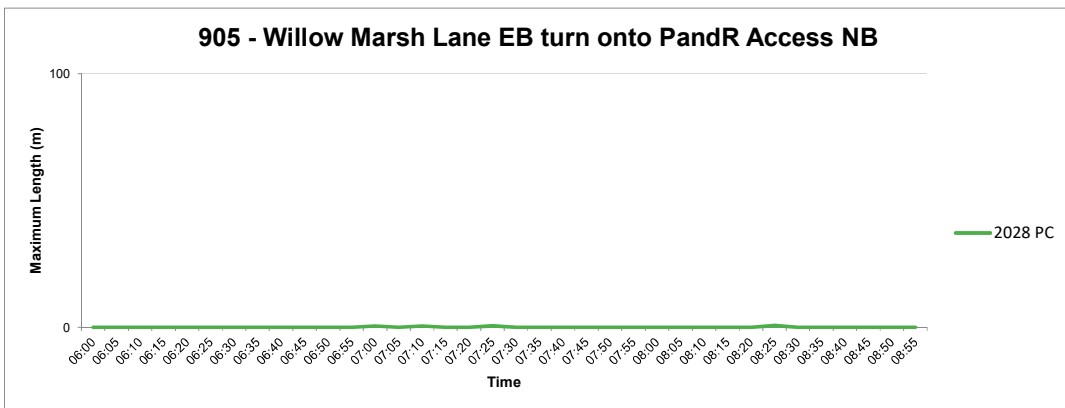
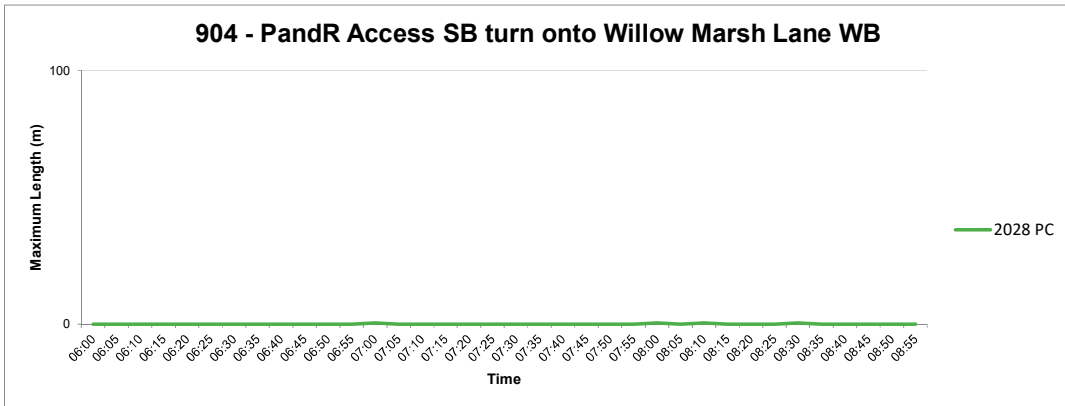



Queue Comparison
PM
Maximum Length Summary
Maximum Length (m)

	2015 BY	2028 RC	2028 PC
301 - A12 NB turn onto High Stre	2.1	1.8	2.3
302 - A12 SB turn onto High Stre	51.0	75.5	86.9
303 - High Street(A1120) EB turn	15.9	24.0	27.9
304 - High Street(A1120) EB turn	9.4	17.2	12.8
401 - A12 NB turn onto B1122 E	7.9	12.8	26.5
402 - B1122 WB turn onto A12 S	41.0	66.5	24.1
403 - B1122 WB turn onto A12 N	39.5	65.0	24.5
404 - A12 SB turn onto B1122 E	0.0	3.3	50.6
501 - A12 NB turn onto Westleto	4.4	6.5	6.4
502 - Westleton Road WB turn o	9.9	12.4	11.2
503 - Westleton Road WB turn o	7.2	11.1	10.4
601 - Darsham Petrol Station tur	11.2	15.4	16.9
602 - Darsham Petrol Station tur	11.5	15.4	17.5
701 - A12 NB turn in to Darsham	26.1	49.8	45.4
801 - A12 NB turn on to The St E	16.1	24.9	30.2
802 - The St WB turn onto A12 S	10.1	12.5	12.8
803 - The St WB turn onto A12 N	13.1	13.1	14.1
901 - A12 SB turn onto Willow M	5.6	10.7	
902 - Willow Marsh Lane EB turn	2.3	3.3	
903 - Willow Marsh Lane EB turn	4.9	4.9	
1001 - A12 NB turn onto Lymball	6.7	18.8	16.9
1002 - Lymballs Lane WB turn o	8.6	8.1	7.6
1003 - Lymballs Lane WB turn o	5.8	5.5	6.2
1101 - A12 SB turn onto A144 W	9.3	5.8	2.0
1102 - A144 EB turn onto A12 N	32.0	37.2	38.3
1103 - A144 EB turn onto A12 S	32.8	37.1	36.6
1104 - A12 SB turn onto A144 W	B first queue		8.1
1201 - Level Crossing A12 NB	159.0	193.5	210.0
1202 - Level Crossing A12 SB	95.7	121.4	141.4
1301 - Level Crossing B1122 EB	10.0	11.5	11.4
1302 - Level Crossing B1122 WB	18.1	20.2	22.2
1401 - PandR Roundabout A12 NB			43.0
1402 - PandR Rouandabout PandR Access			26.9
1403 - PandR Roundabout A12 SB			31.9
904 - PandR Access SB turn onto Willow Marsh Lane			5.1
905 - Willow Marsh Lane EB turn onto PandR Access			1.7
906 - Willow Marsh Lane EB turn onto PandR Access			1.3

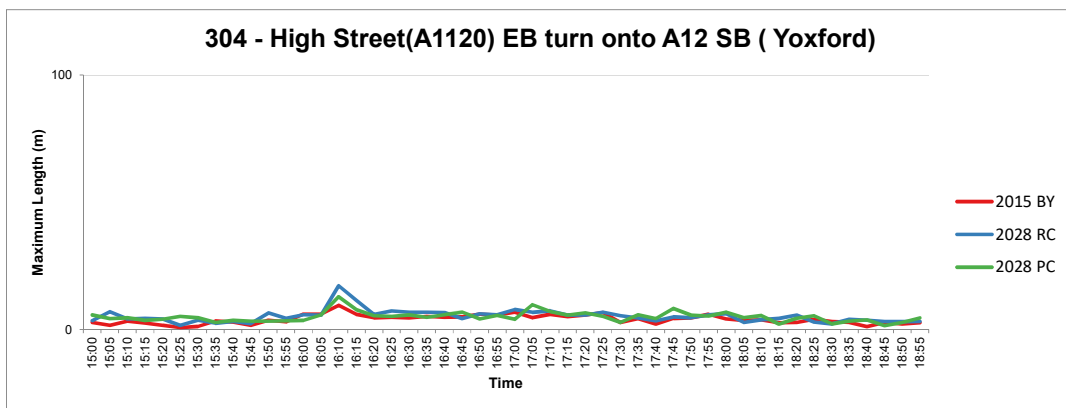
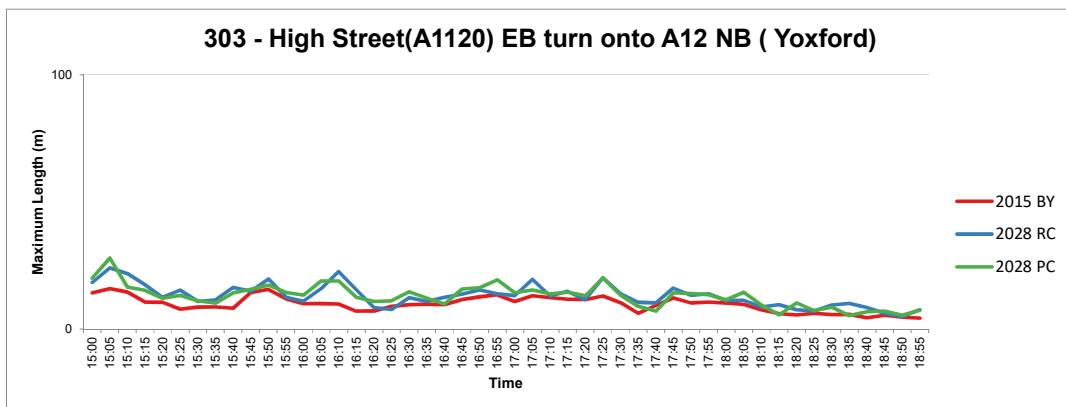
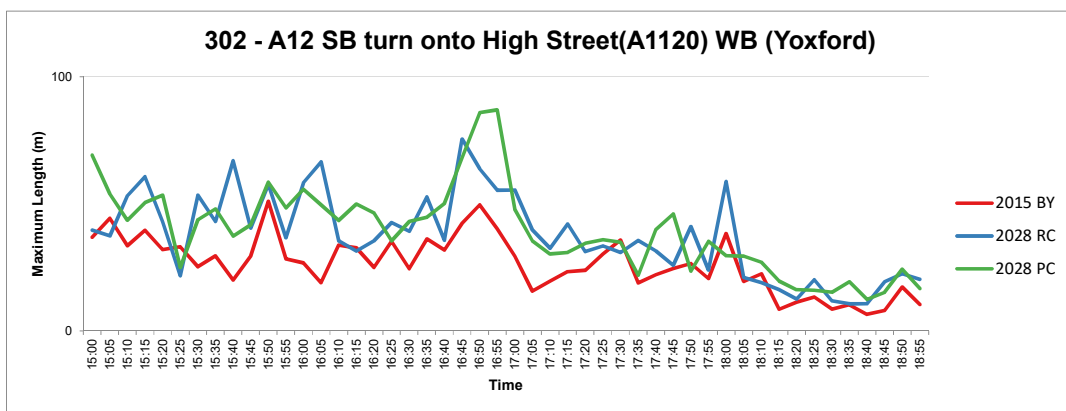
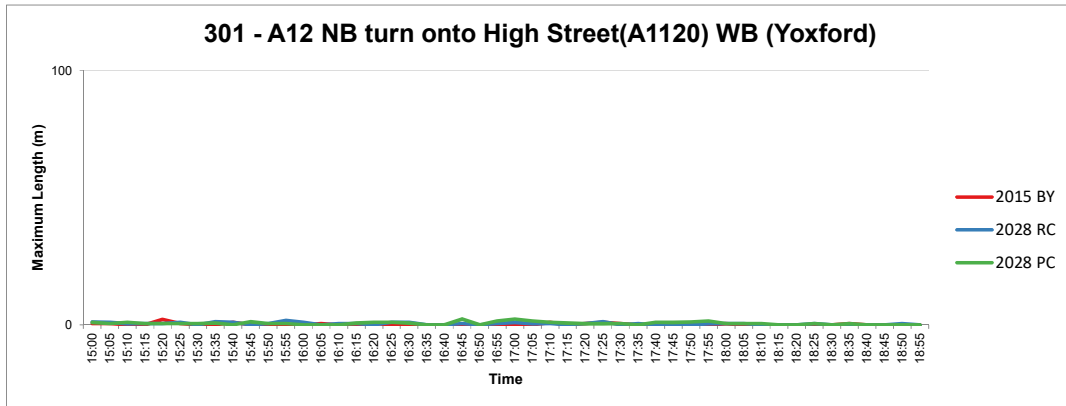

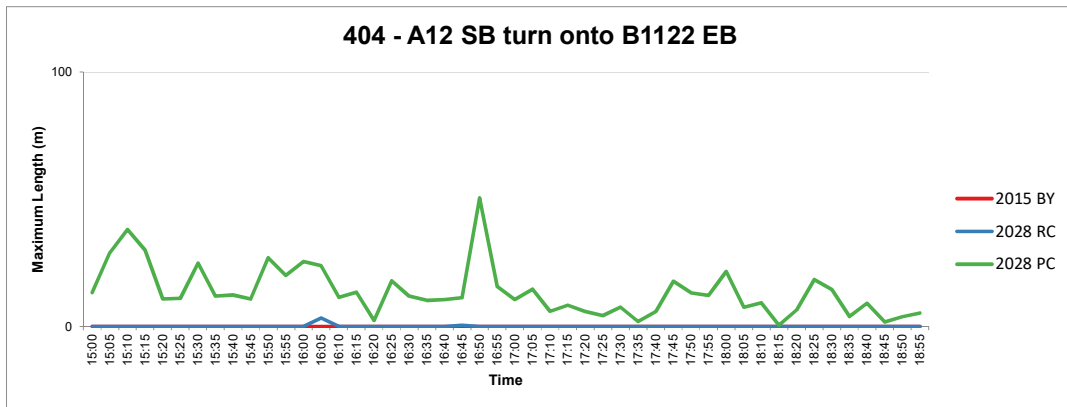
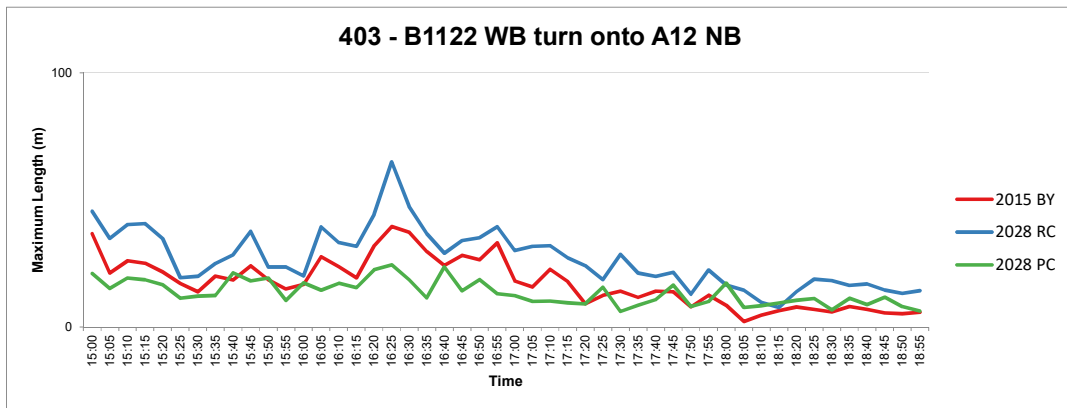
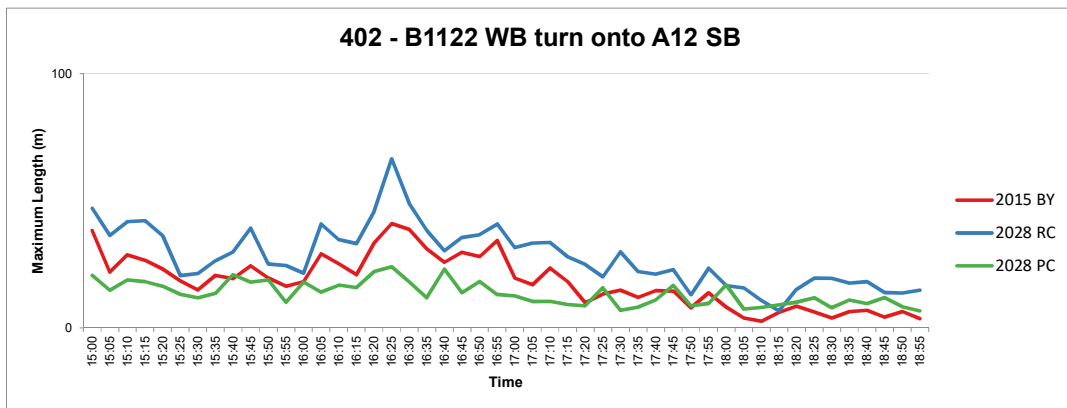
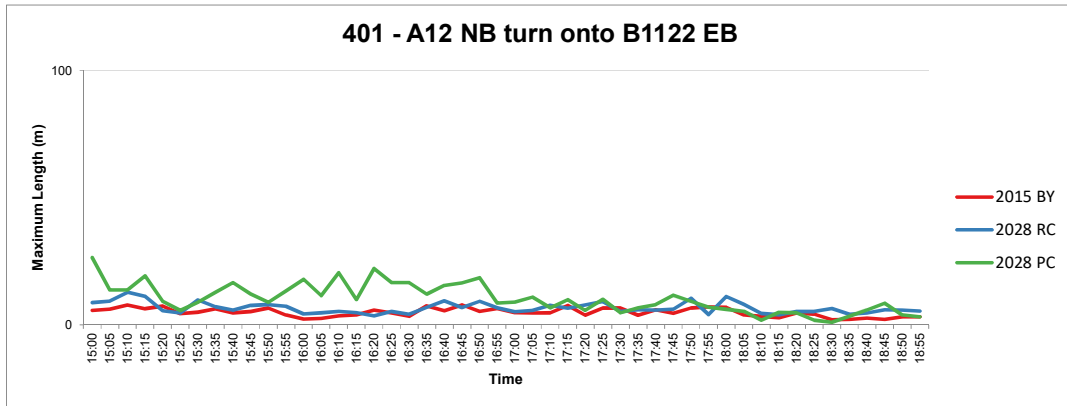



501 - A12 NB turn onto Westleton Road EB

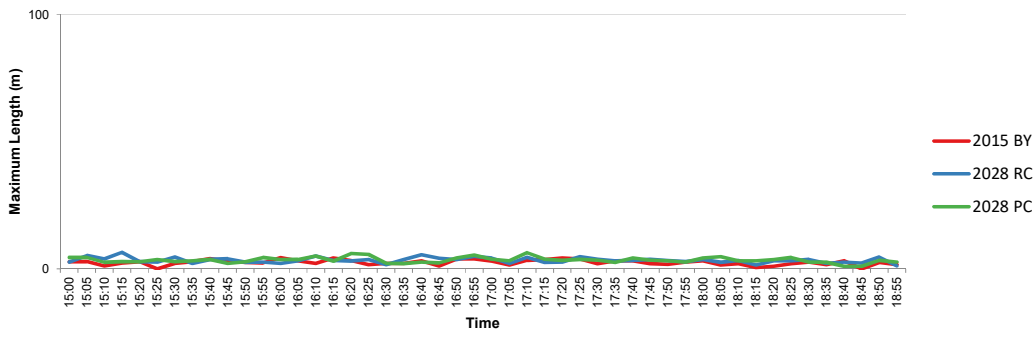

502 - Westleton Road WB turn onto A12 SB

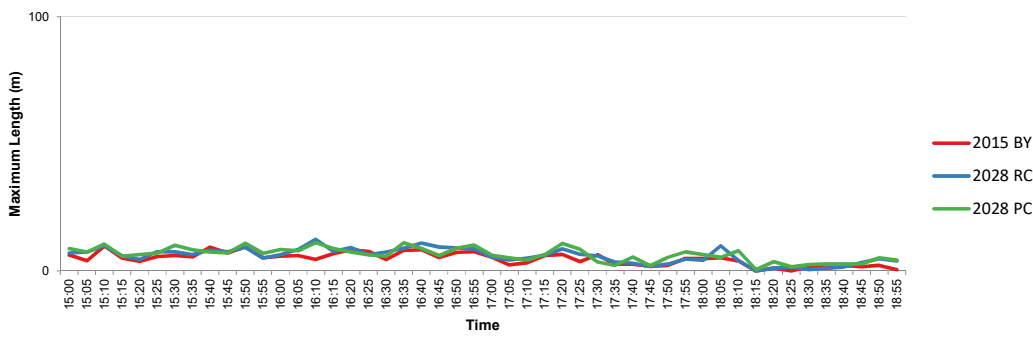

503 - Westleton Road WB turn onto A12 NB

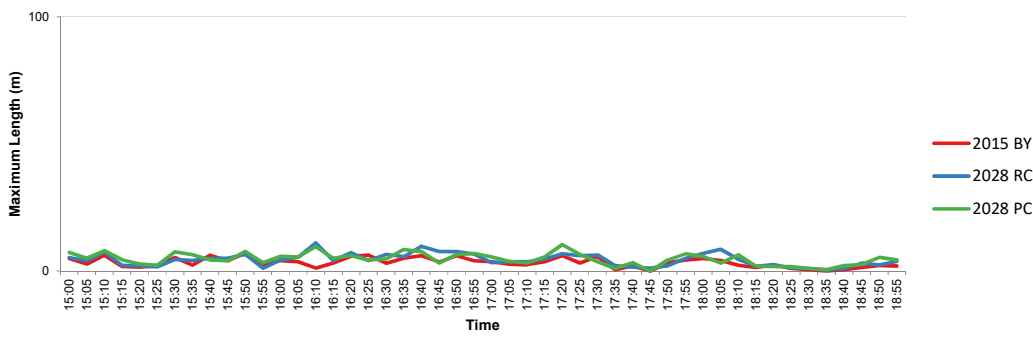



601 - Darsham Petrol Station turn onto A12 SB

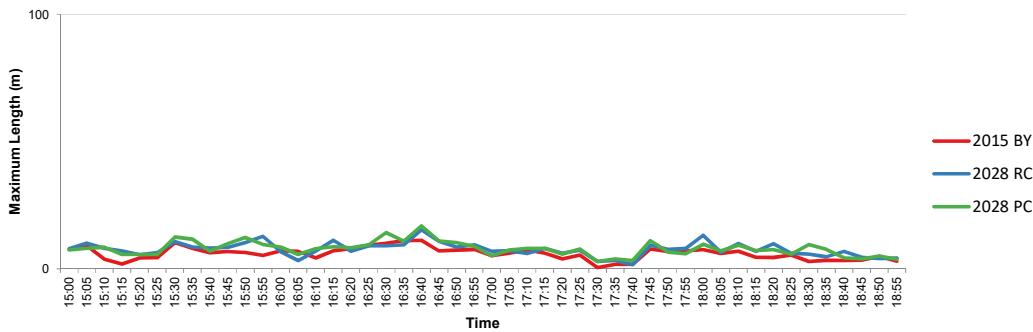

602 - Darsham Petrol Station turn onto A12 NB

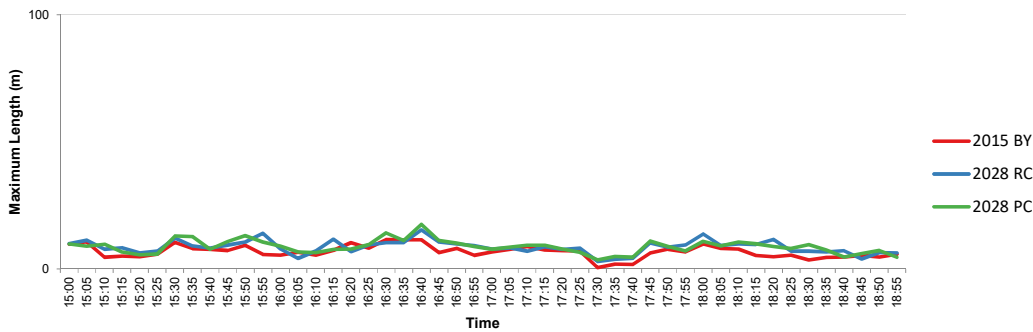

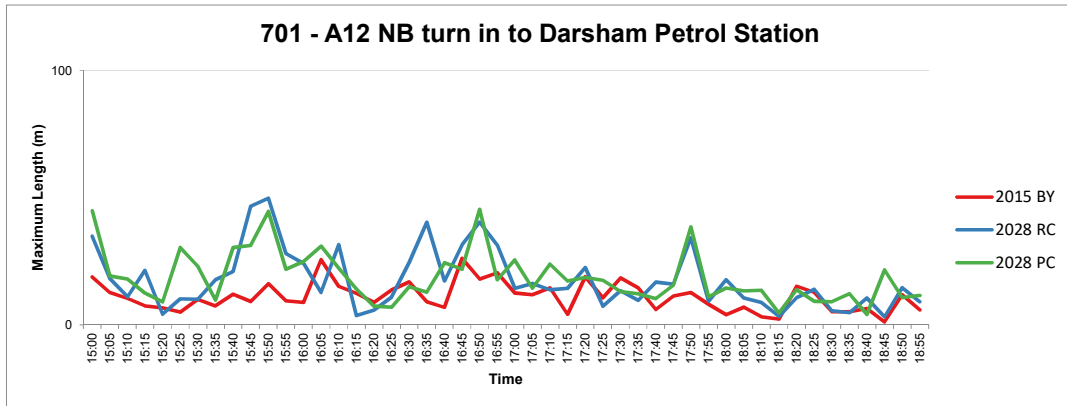

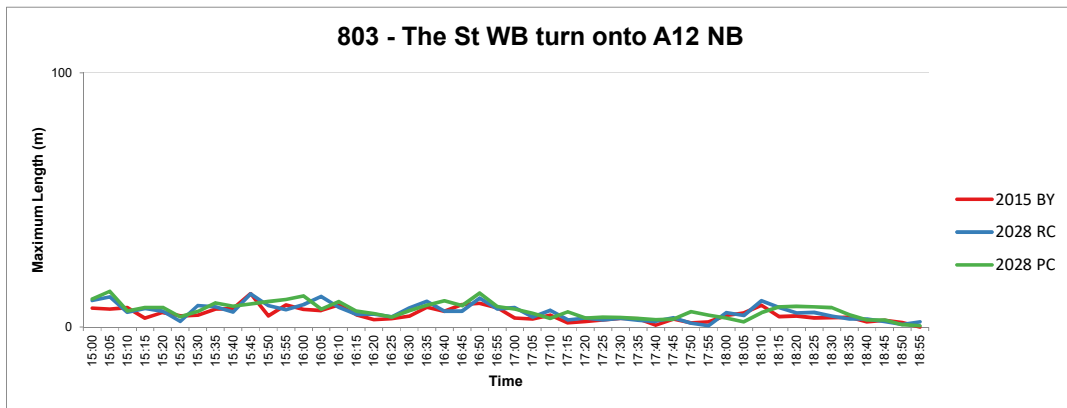
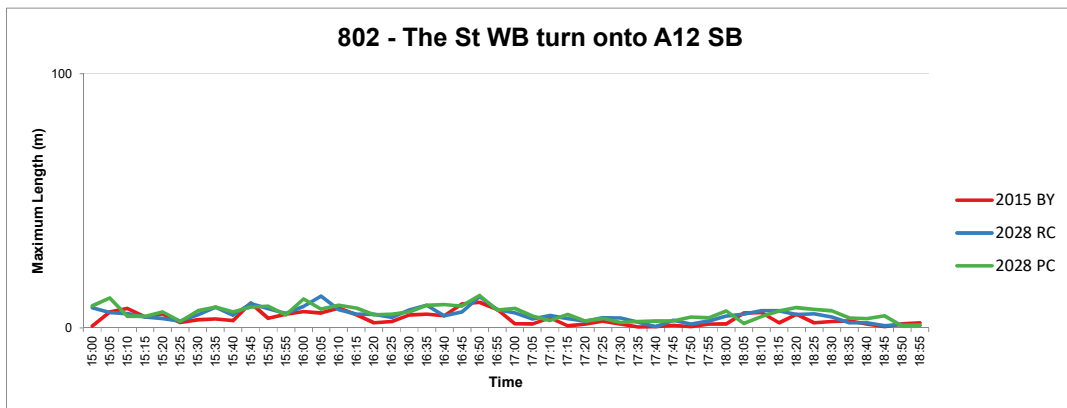
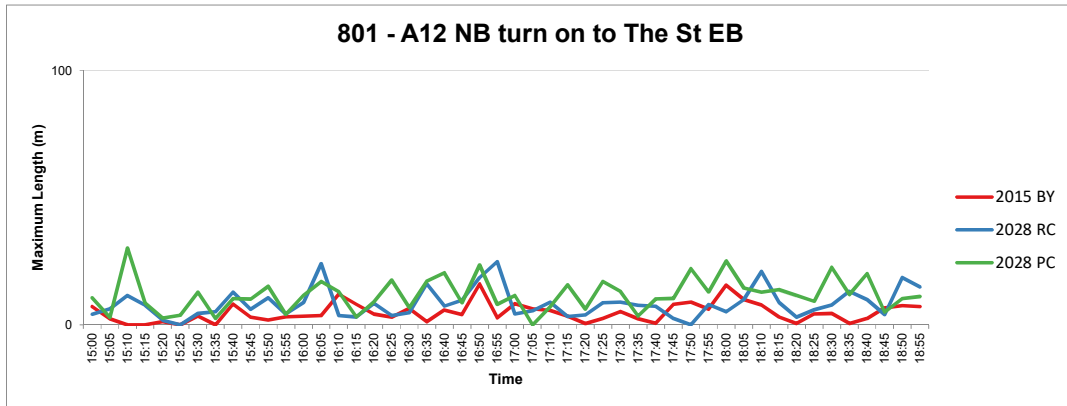

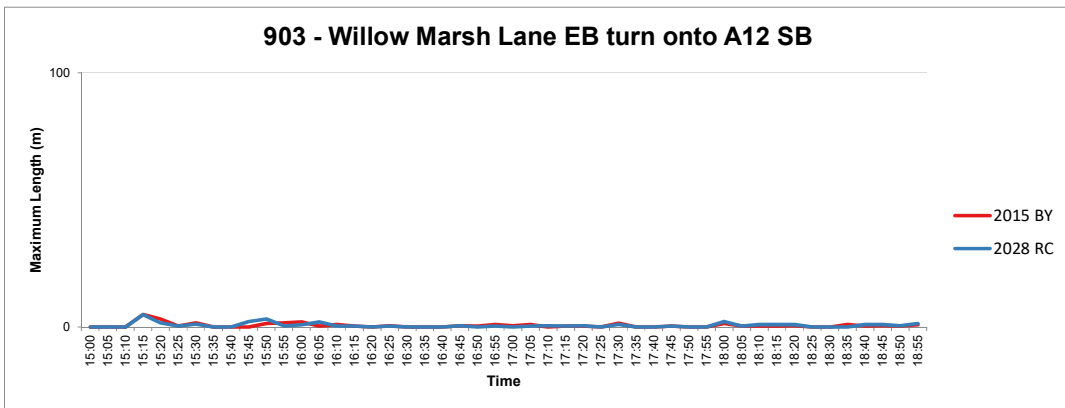
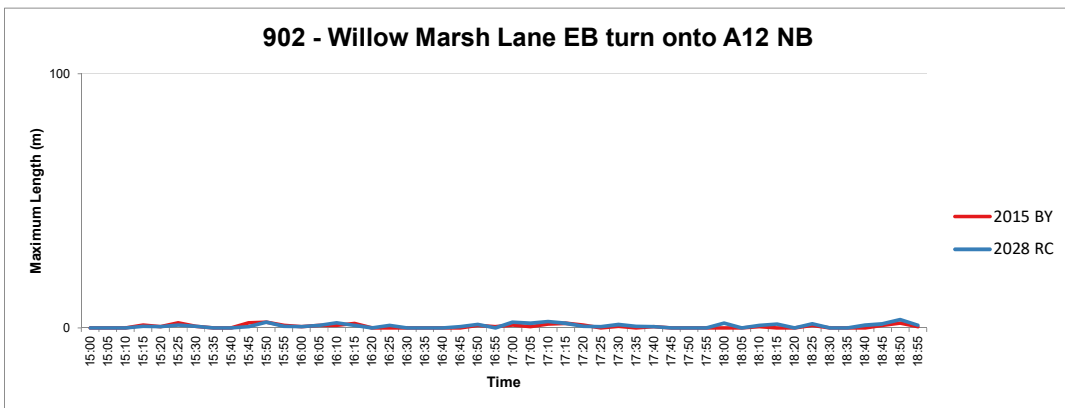
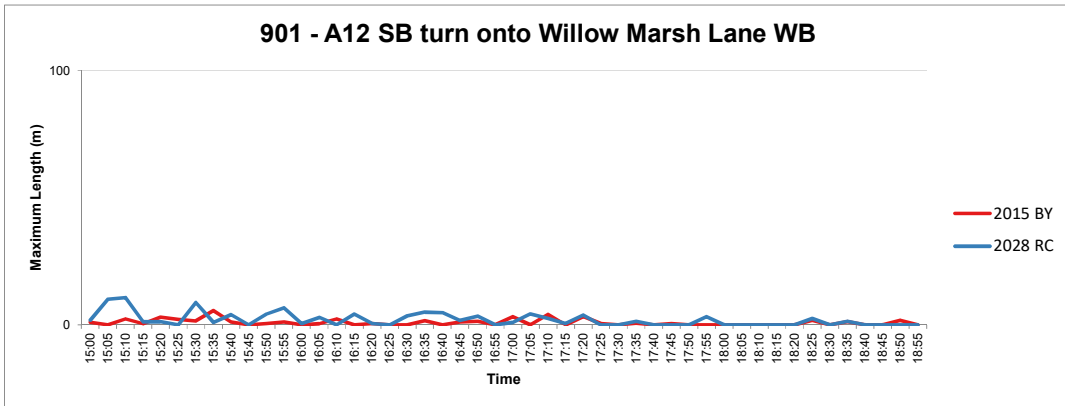

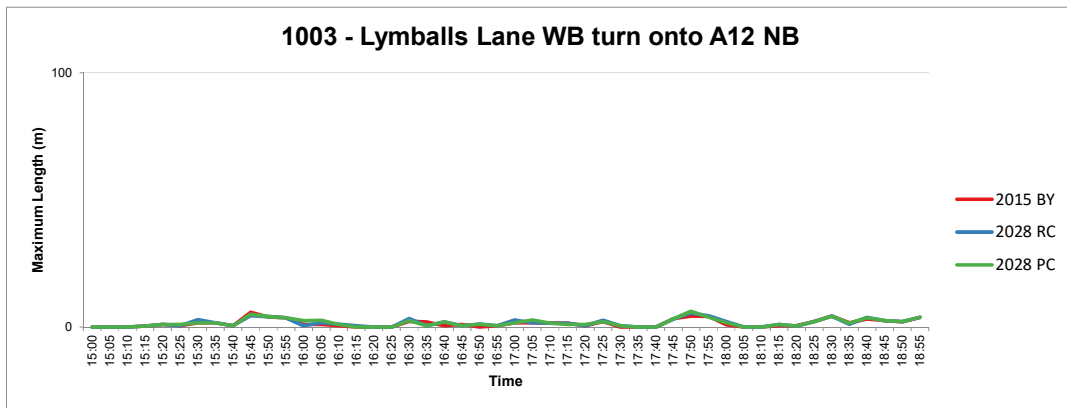
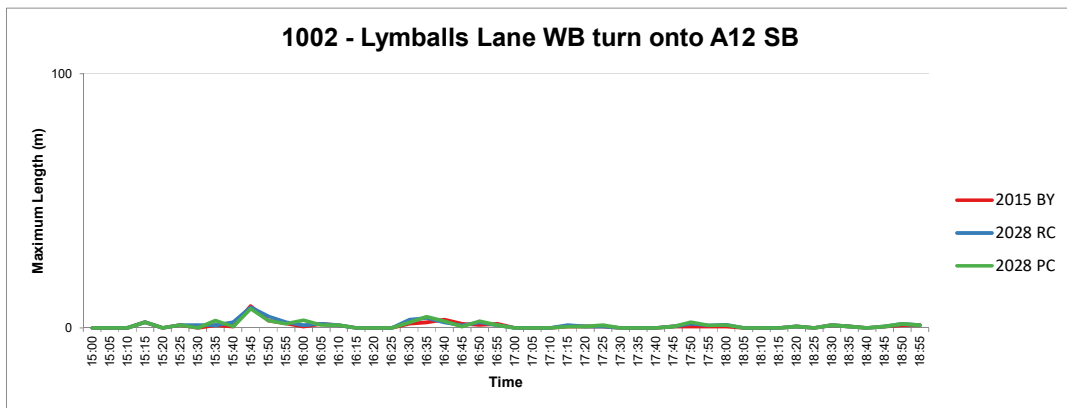
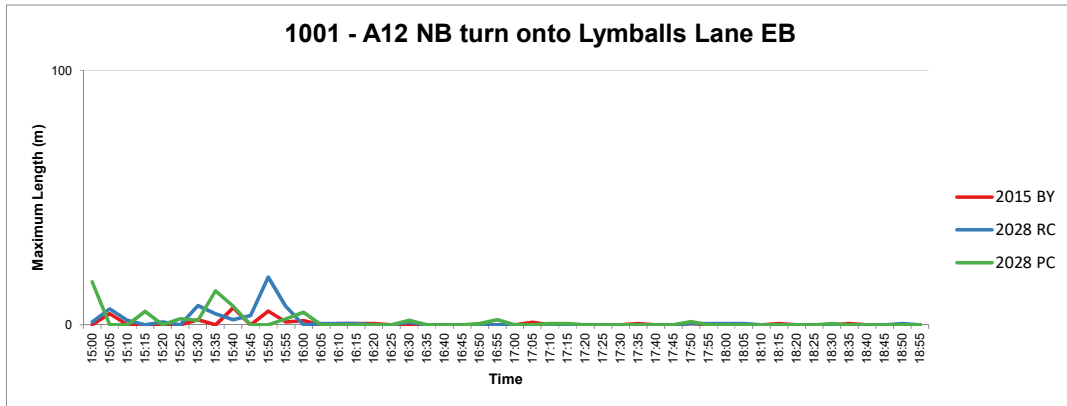

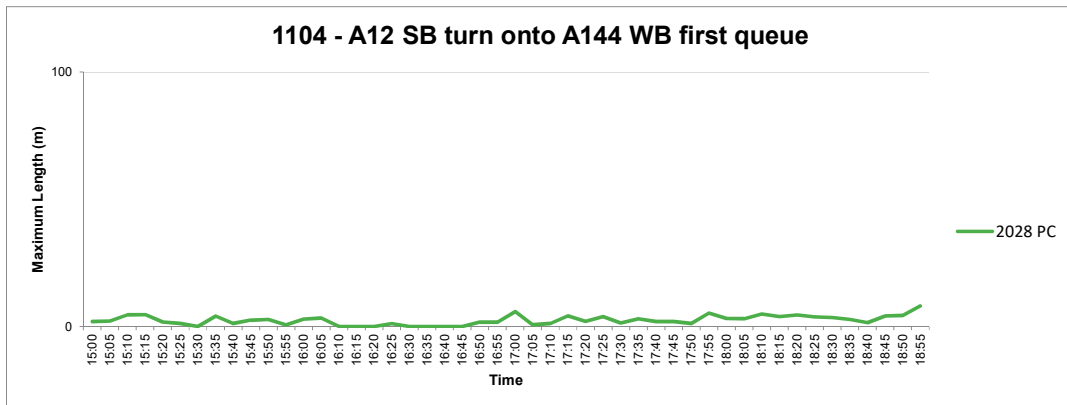
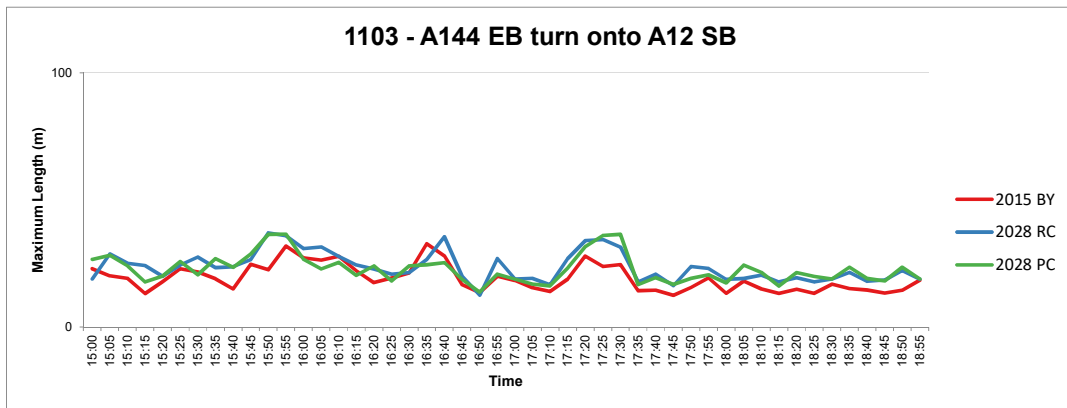
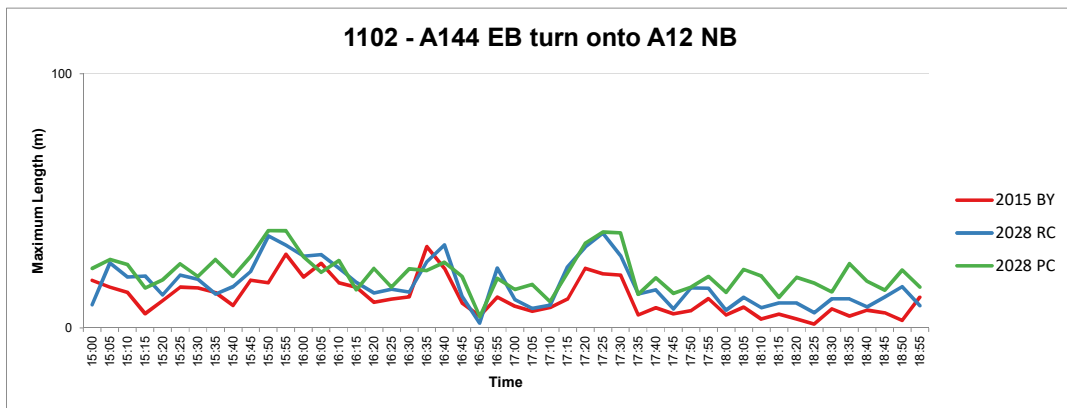
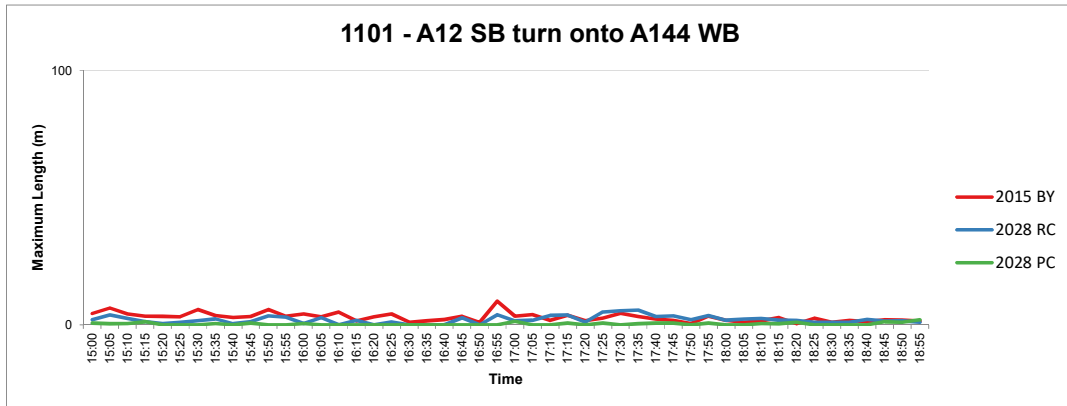

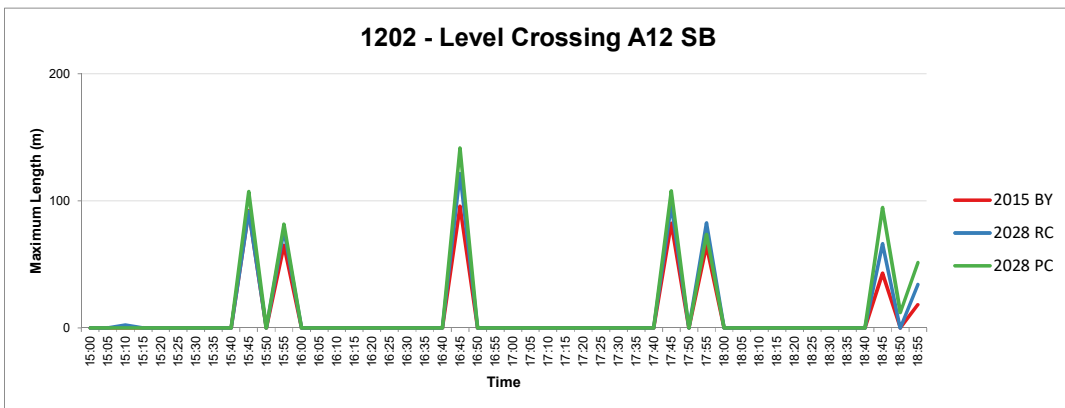
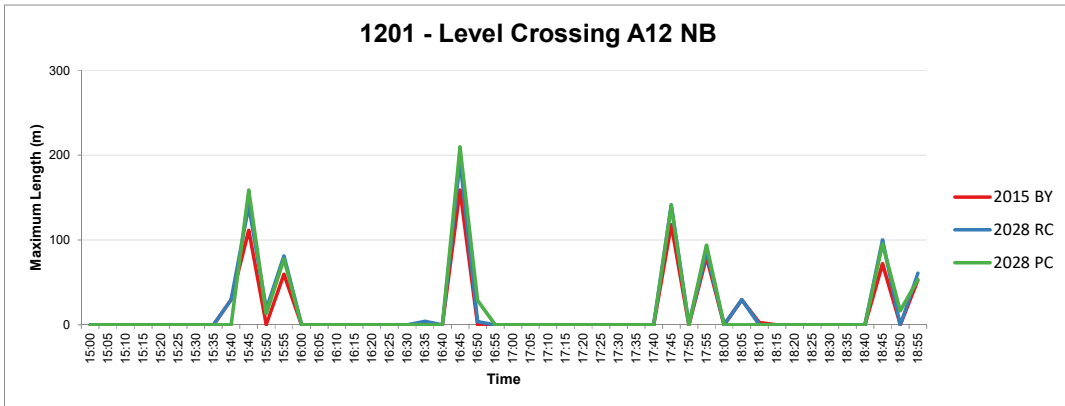

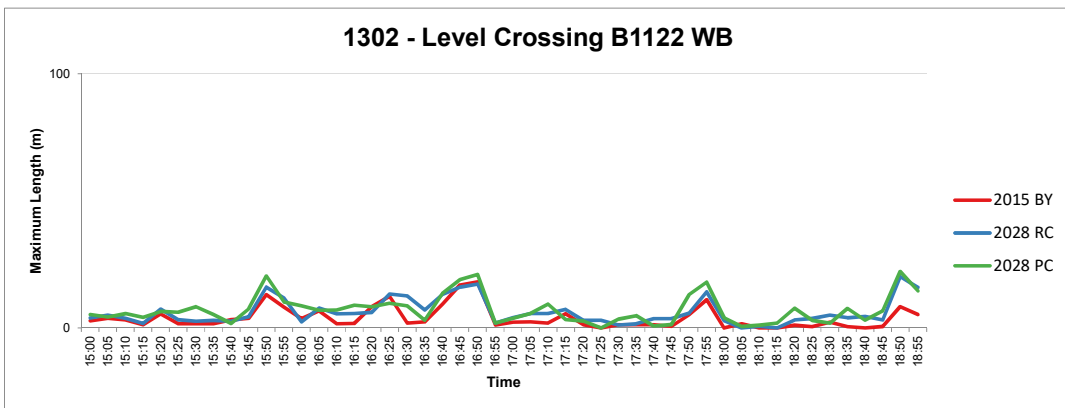
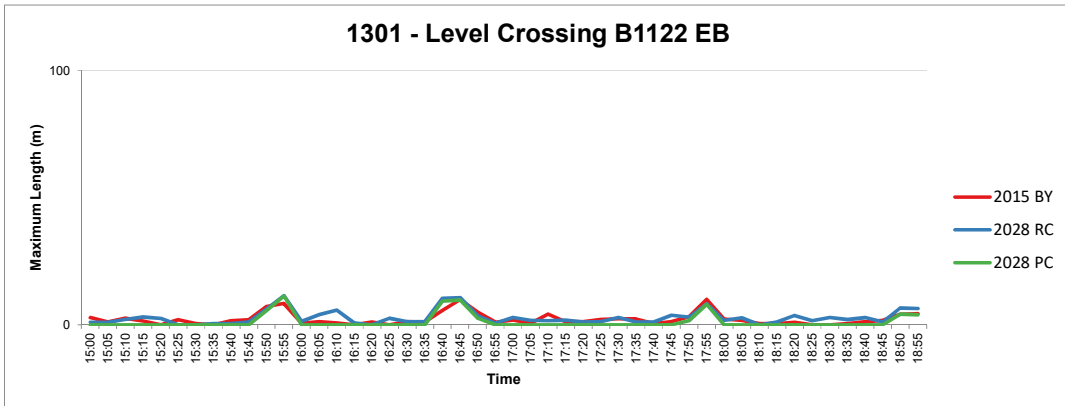

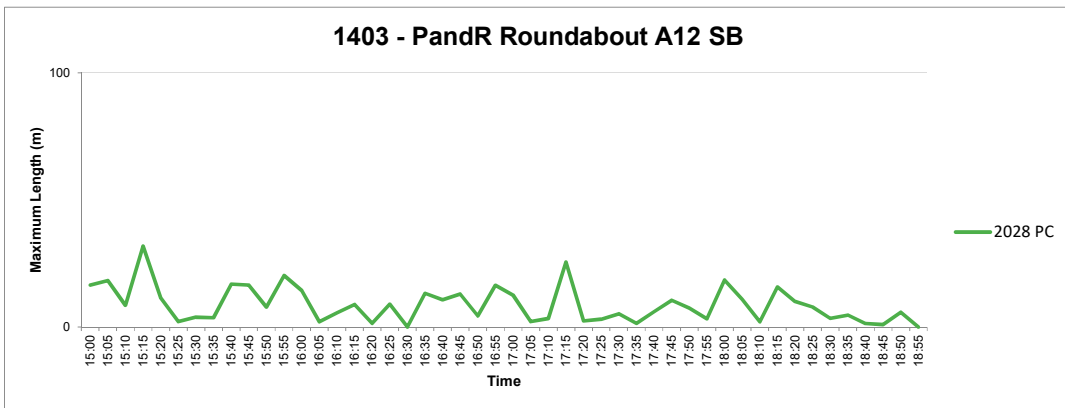
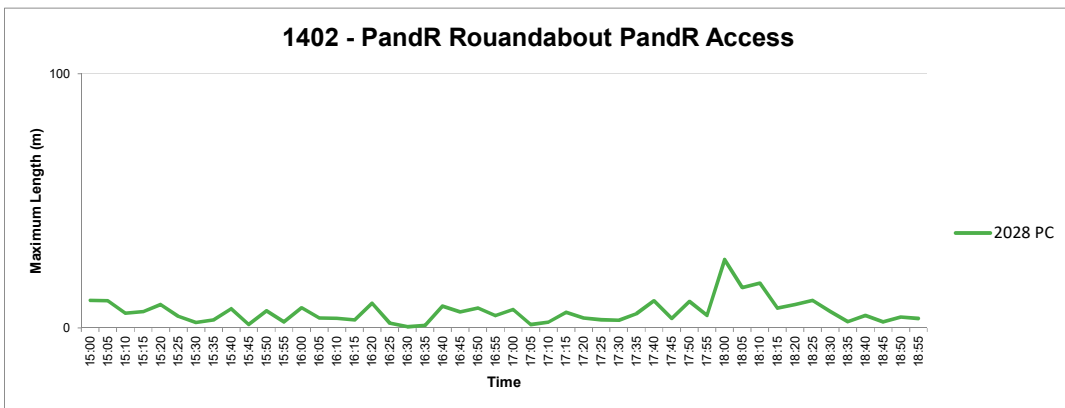
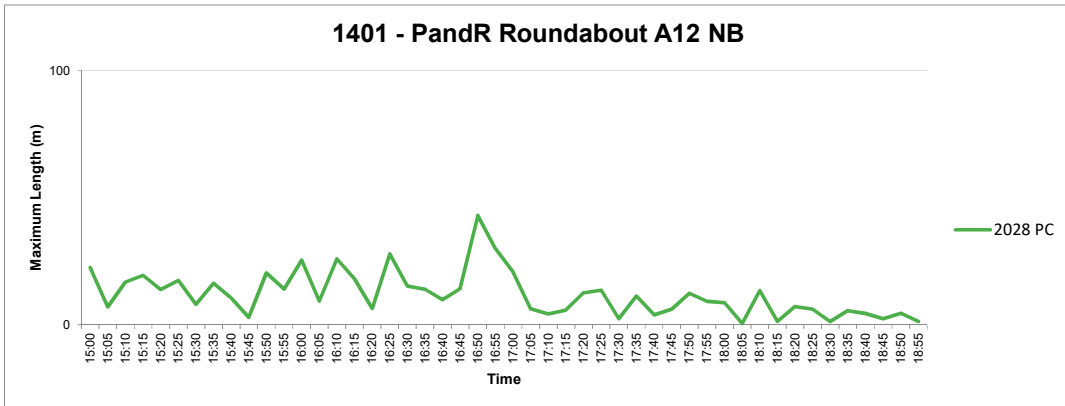

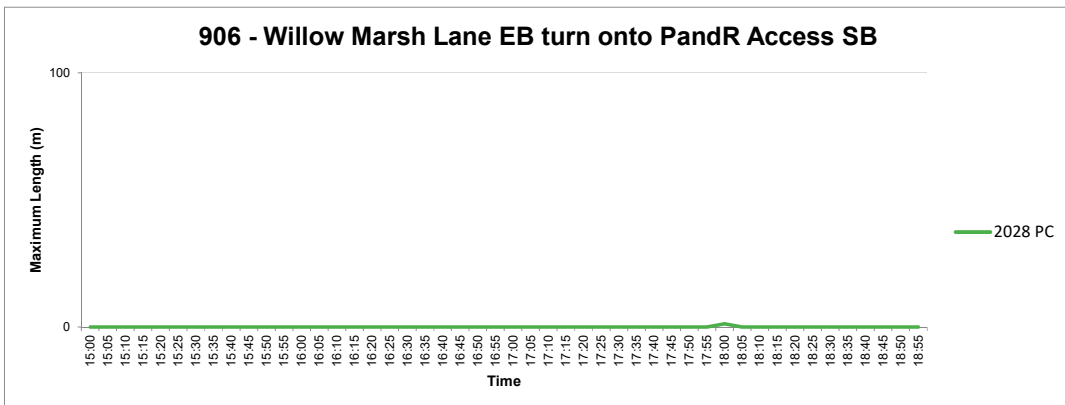
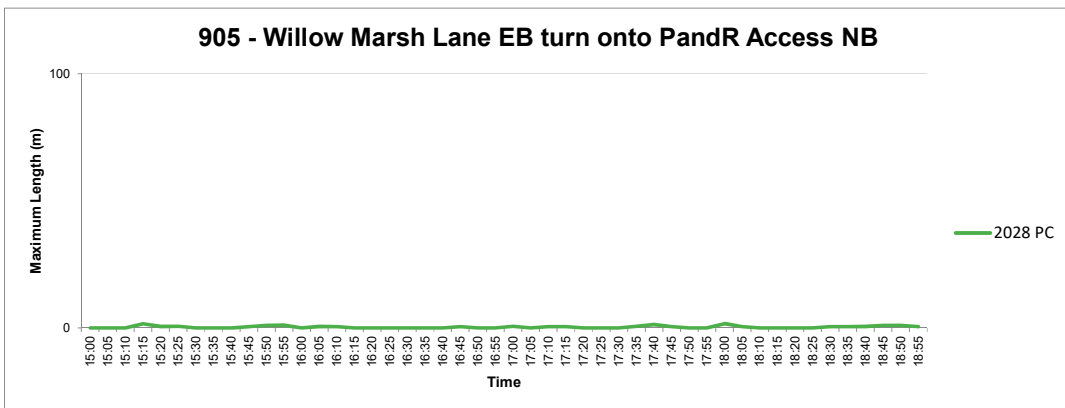
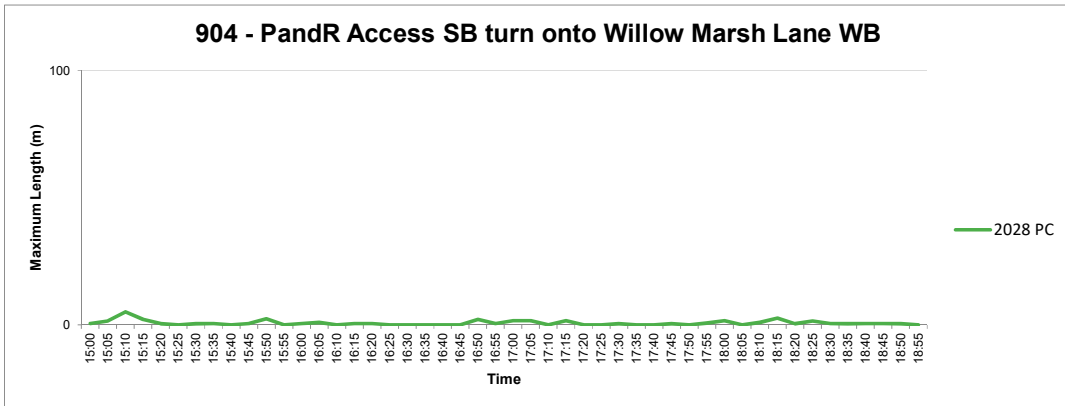

Appendix E

2034 FORECAST MODEL RESULTS

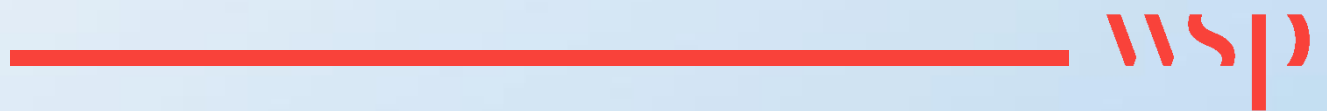



	2015 BY (AM)	2034 RC (AM)	2034 OP (AM)	2015 BY (PM)	2034 RC (PM)	2034 OP (PM)
Total Time Taken (s)	989514	1275266	1270252	1797945	2246111	2215334
Total Distance (m)	17192684	21671561	21609683	31020763	37835900	37477436
Total Vehicles	3124	3936	3859	5858	7193	7008
Total Delay (s)	87147	130316	128245	166614	244299	231704
Average Time (s) / Vehicle	317	324	329	307	312	316
Average Time (s) / Mile	93	95	95	93	96	95
Average Distance (m) / Vehicle	5504	5506	5599	5295	5260	5348
Average Speed (mph)	39	38	38	39	38	38
Average Speed (kph)	63	61	61	62	61	61
Average Delay / Vehicle	28	33	33	28	34	33

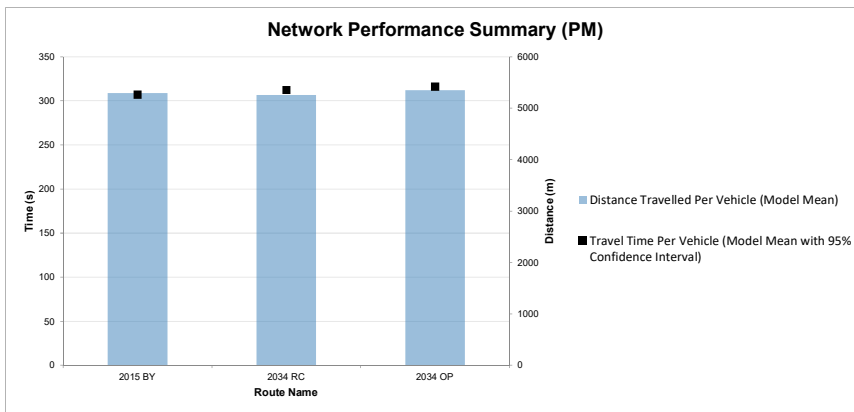
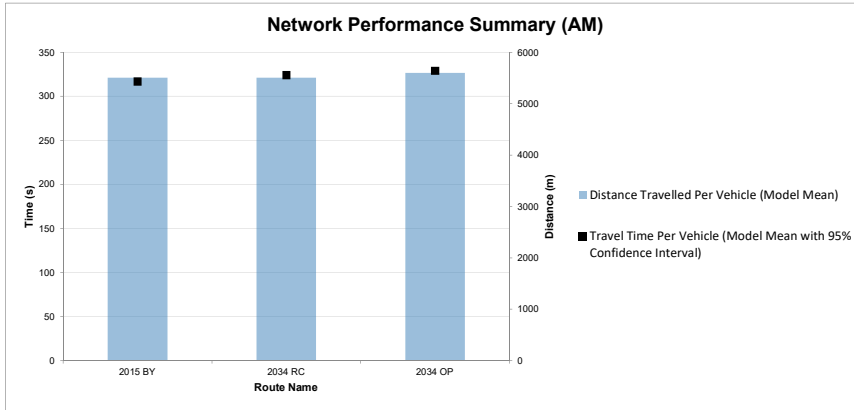

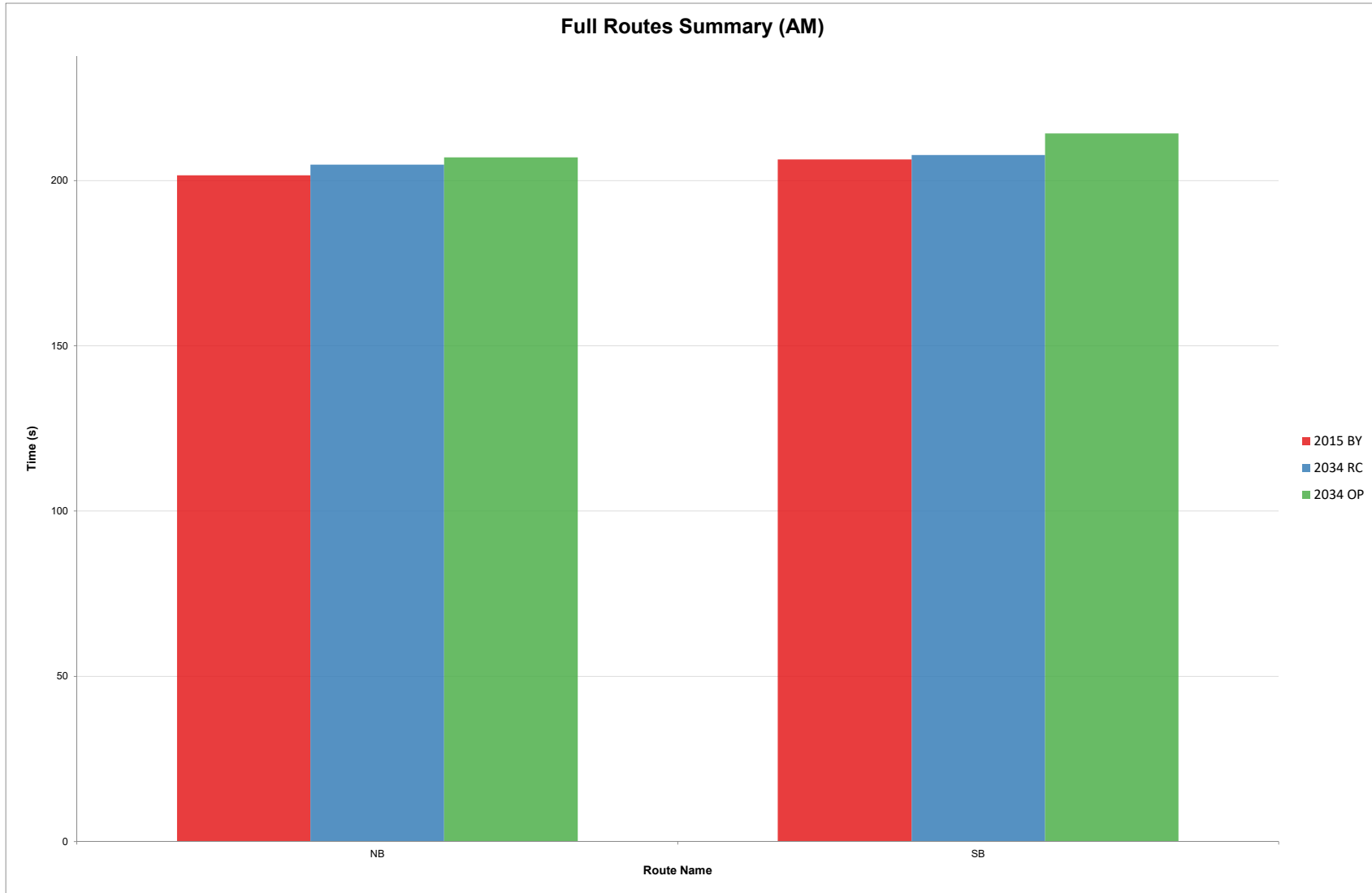



Journey Time Summary for NB

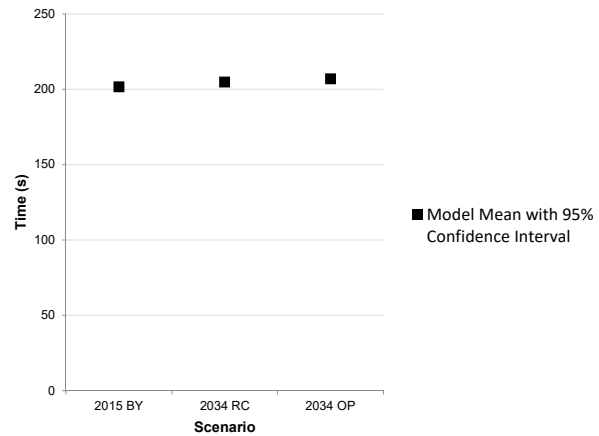

Journey Time Summary by Distance for NB

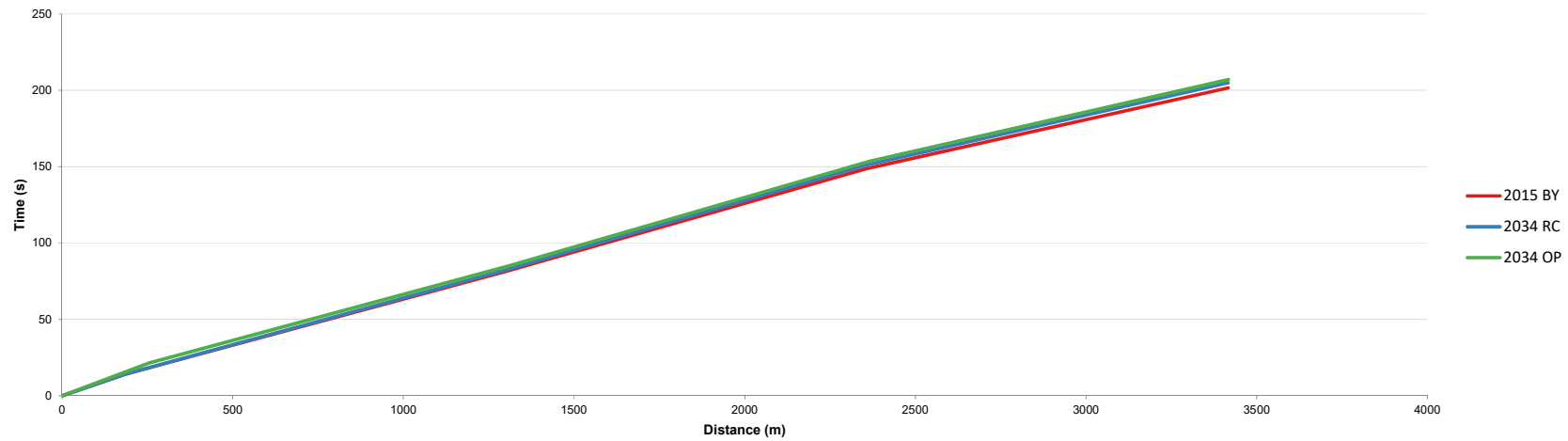



Journey Time Summary for SB

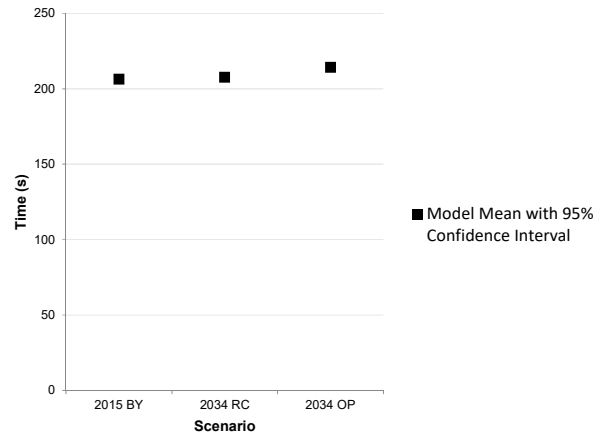

Journey Time Summary by Distance for SB

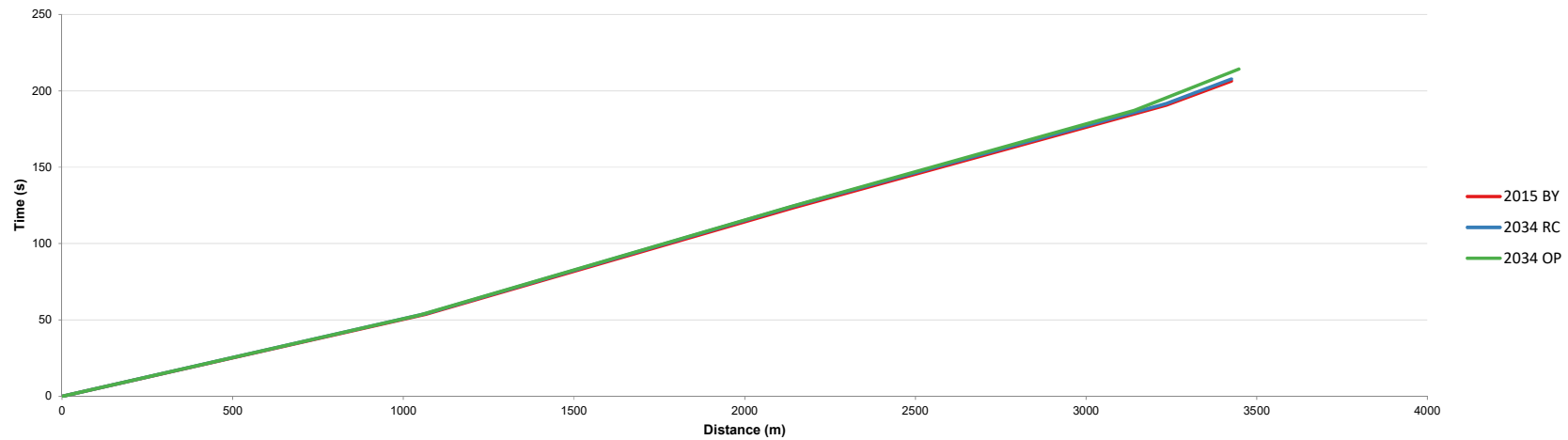

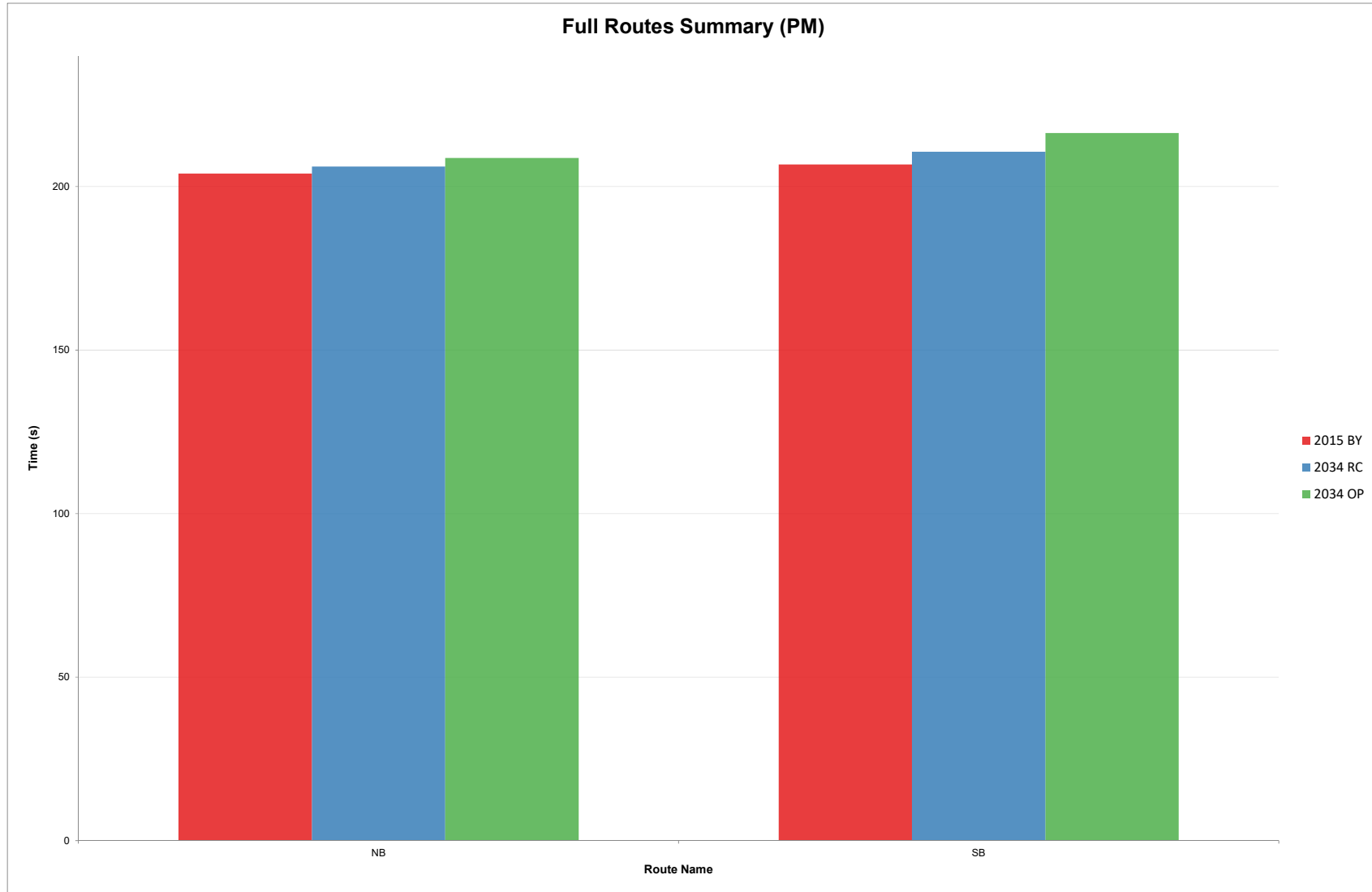



**Journey Time Summary
for NB**

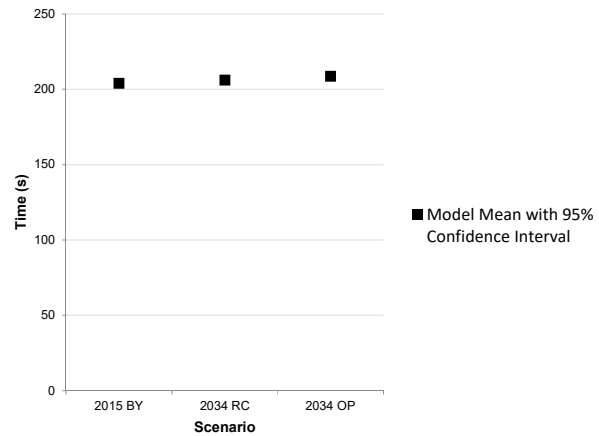

Journey Time Summary by Distance for NB

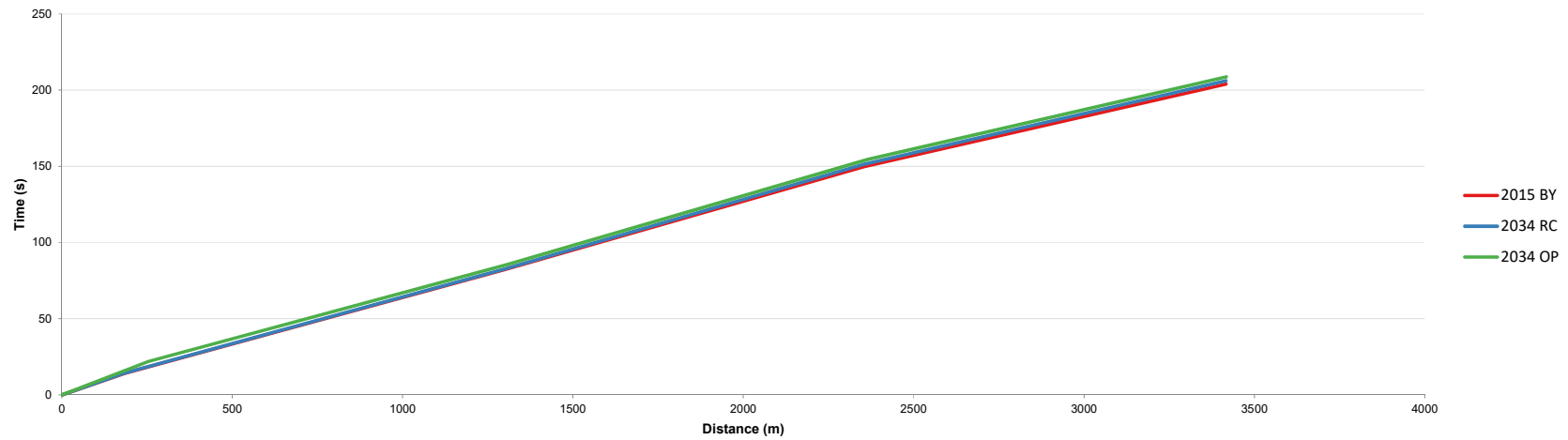



**Journey Time Summary
for SB**

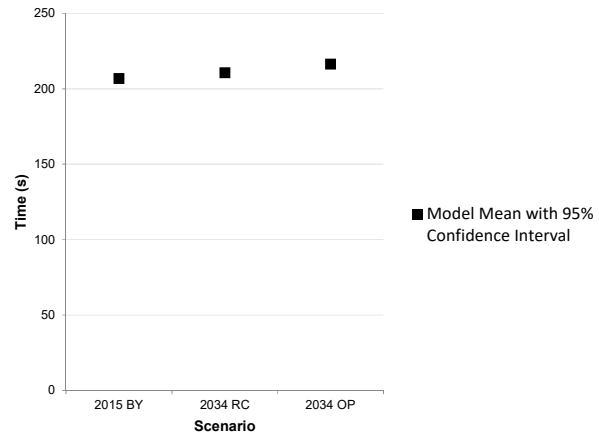

Journey Time Summary by Distance for SB

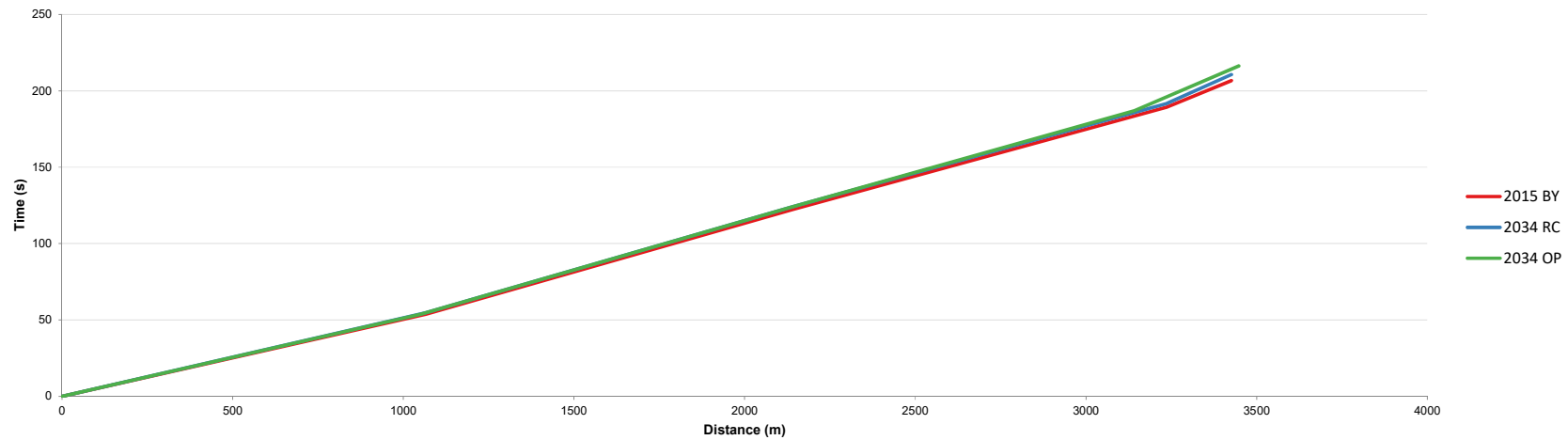



Journey Time Table
AM
2034

Route Names	2015 BY	2034 RC	2034 OP
1 - Section 1 NB	14	14	21
2 - Section 2 NB	67	68	64
3 - Section 3 NB	67	69	69
4 - Section 4 NB	53	54	53
NB	202	205	207
5 - Section 1 SB	54	54	53
6 - Section 2 SB	70	70	71
7 - Section 3 SB	67	68	63
8 - Section 4 SB	16	16	27
SB	206	208	214



Journey Time Table
PM
2034

Route Names	2015 BY	2034 RC	2034 OP
1 - Section 1 NB	14	14	22
2 - Section 2 NB	68	68	64
3 - Section 3 NB	68	69	69
4 - Section 4 NB	54	55	54
NB	204	206	209
5 - Section 1 SB	54	55	54
6 - Section 2 SB	69	69	70
7 - Section 3 SB	67	68	64
8 - Section 4 SB	17	19	29
SB	207	211	216



Queue Comparison
AM
Maximum Length Summary
Maximum Length (m)

	2015 BY	2034 RC	2034 OP
301 - A12 NB turn onto High Street	0.0	0.5	1.0
302 - A12 SB turn onto High Street	37.2	36.1	49.0
303 - High Street(A1120) EB turn	16.0	22.1	22.6
304 - High Street(A1120) EB turn	7.8	10.2	11.8
401 - A12 NB turn onto B1122 EB	12.0	16.5	12.0
402 - B1122 WB turn onto A12 SB	16.1	31.9	12.3
403 - B1122 WB turn onto A12 NB	16.2	30.4	12.6
404 - A12 SB turn onto B1122 EB	0.0	0.0	40.0
501 - A12 NB turn onto Westleton Road	8.6	5.9	10.6
502 - Westleton Road WB turn onto A12 NB	5.7	6.8	7.1
503 - Westleton Road WB turn onto A12 SB	3.6	6.6	6.0
601 - Darsham Petrol Station turn	11.9	12.0	14.2
602 - Darsham Petrol Station turn	12.4	12.7	16.3
701 - A12 NB turn in to Darsham Lane	27.8	80.9	50.0
801 - A12 NB turn on to The Street	14.4	32.8	39.2
802 - The Street WB turn onto A12 SB	6.6	6.5	7.3
803 - The Street WB turn onto A12 NB	8.8	9.7	9.5
901 - A12 SB turn onto Willow Marsh Lane	4.2	5.2	9.1
902 - Willow Marsh Lane EB turn	3.3	3.6	2.6
903 - Willow Marsh Lane EB turn	4.8	7.4	8.1
1001 - A12 NB turn onto Lymballs Lane	3.6	1.5	3.7
1002 - Lymballs Lane WB turn onto A12 NB	5.2	4.4	4.1
1003 - Lymballs Lane WB turn onto A12 SB	3.7	4.3	4.6
1101 - A12 SB turn onto A144 WB	6.9	5.1	3.4
1102 - A144 EB turn onto A12 NB	61.7	76.1	81.6
1103 - A144 EB turn onto A12 SB	62.0	76.8	79.0
1104 - A12 SB turn onto A144 WB B first queue			12.6
1201 - Level Crossing A12 NB	107.8	153.7	151.7
1202 - Level Crossing A12 SB	161.3	215.5	215.8
1301 - Level Crossing B1122 EB	22.0	22.8	17.2
1302 - Level Crossing B1122 WB	6.9	14.3	12.6
1401 - PandR Roundabout A12 NB			
1402 - PandR Roundabout PandR Access			
1403 - PandR Roundabout A12 SB			
904 - PandR Access SB turn onto Willow Marsh Lane WB			
905 - Willow Marsh Lane EB turn onto PandR Access NB			
906 - Willow Marsh Lane EB turn onto PandR Access SB			

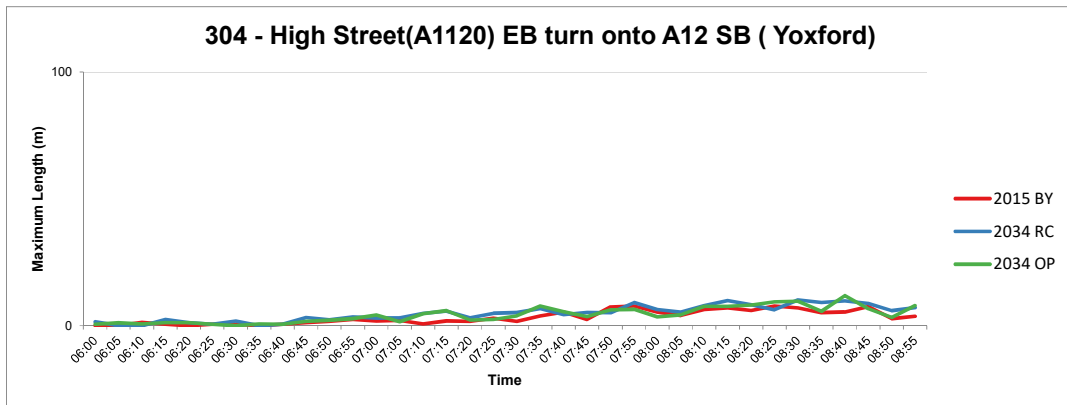
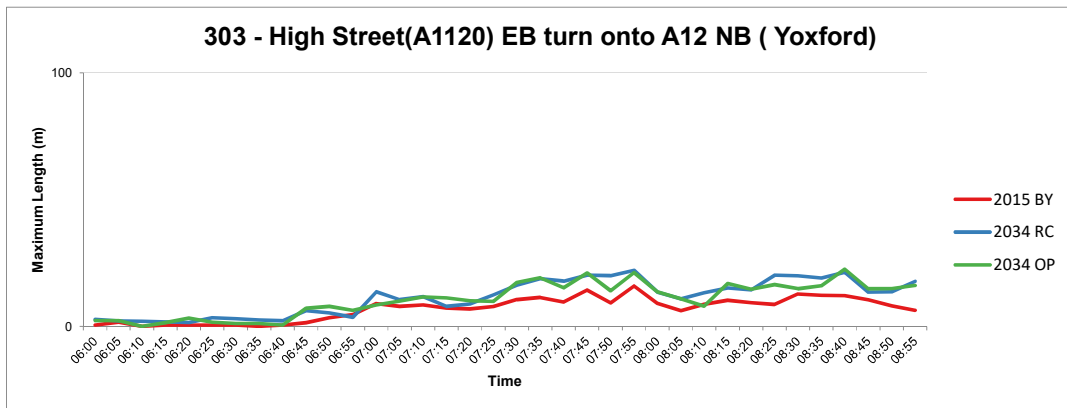
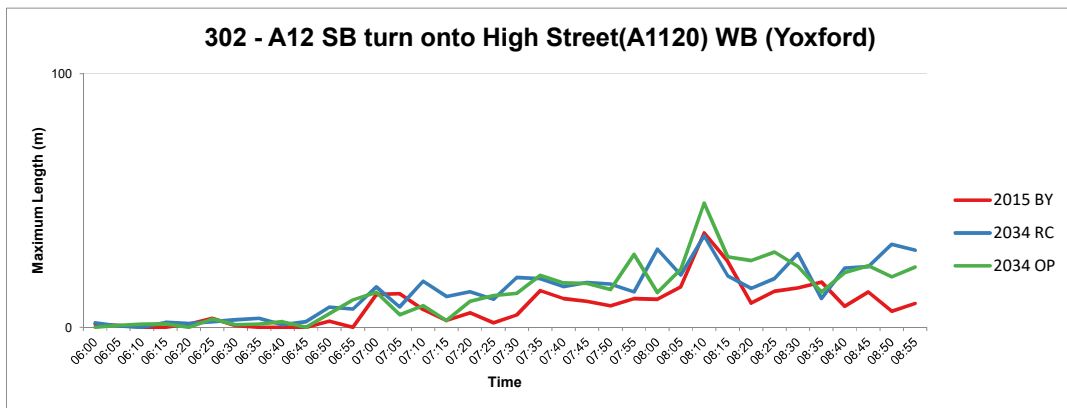
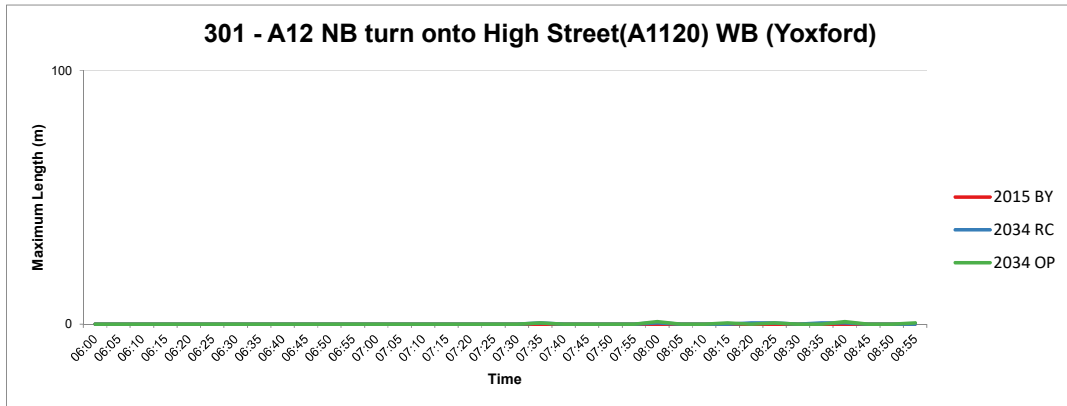

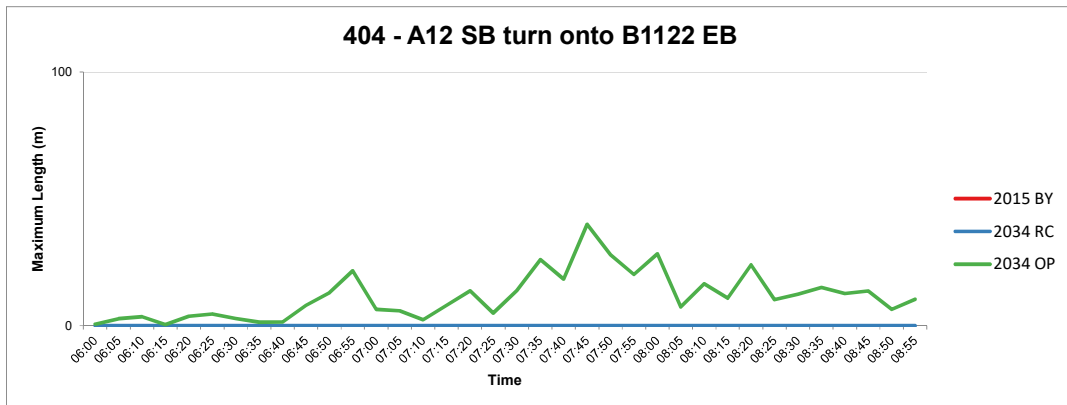
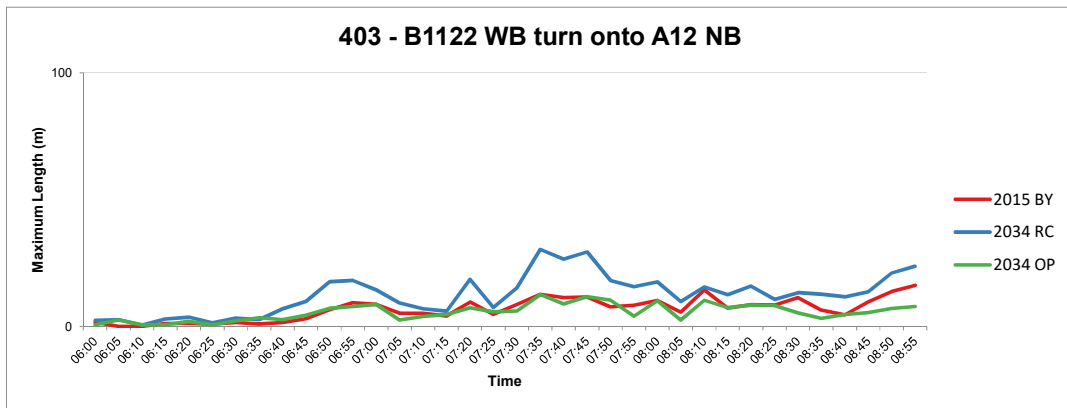
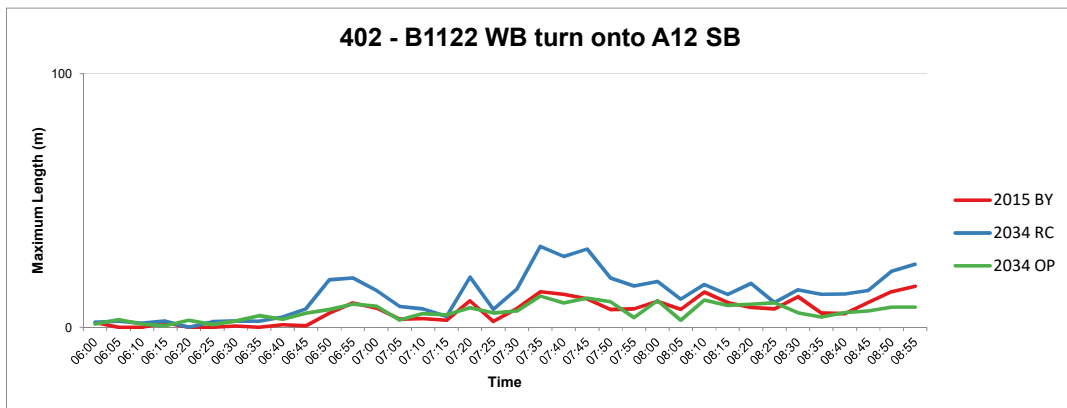
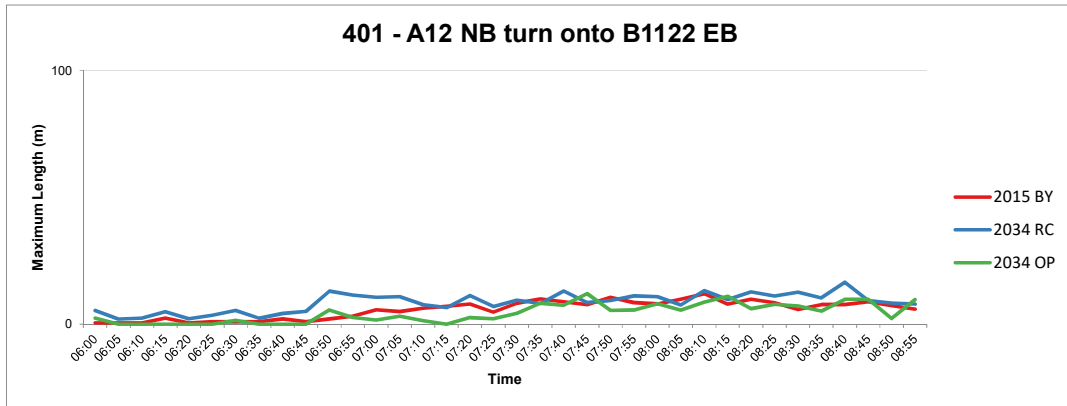

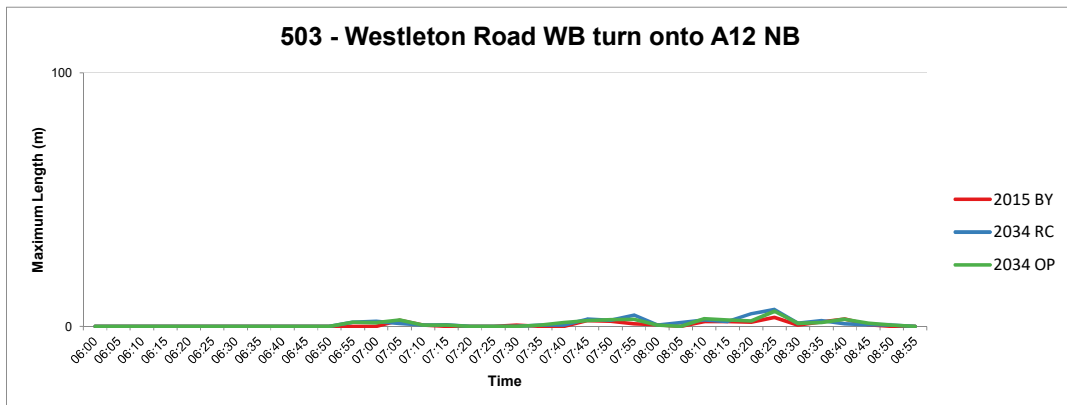
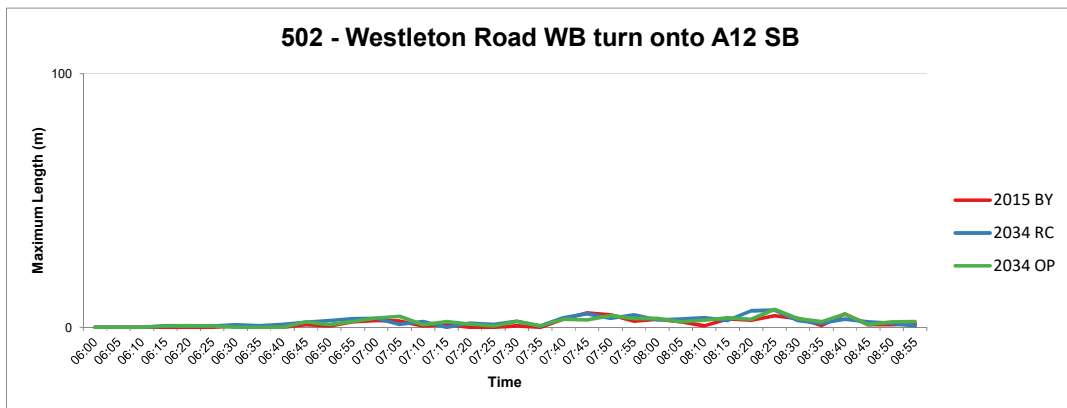
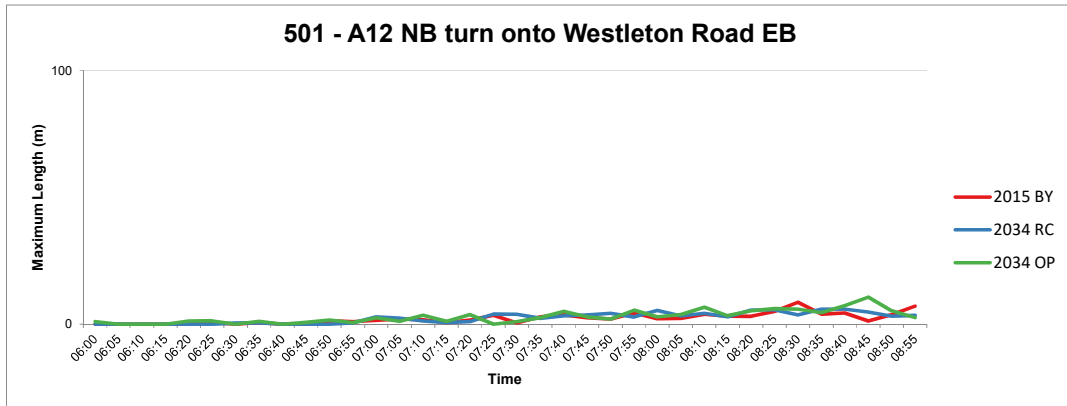

601 - Darsham Petrol Station turn onto A12 SB

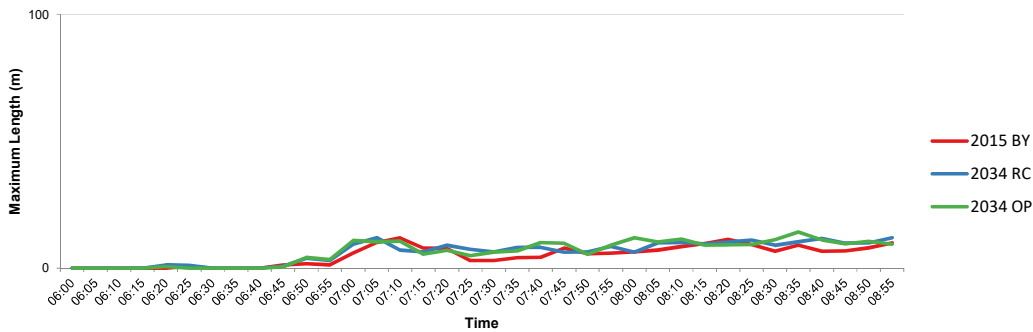

602 - Darsham Petrol Station turn onto A12 NB

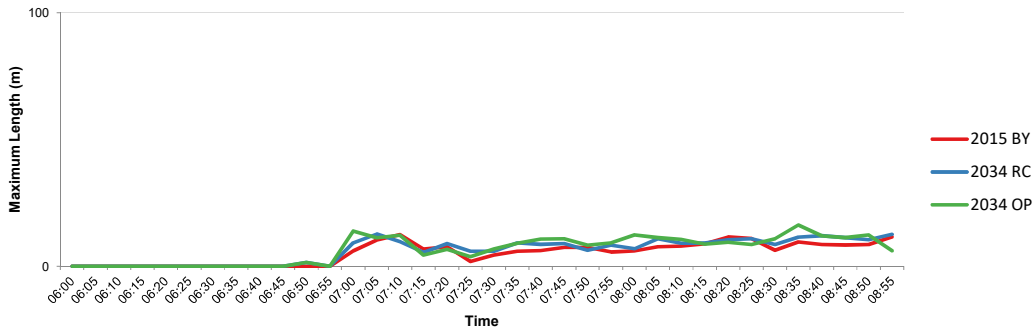

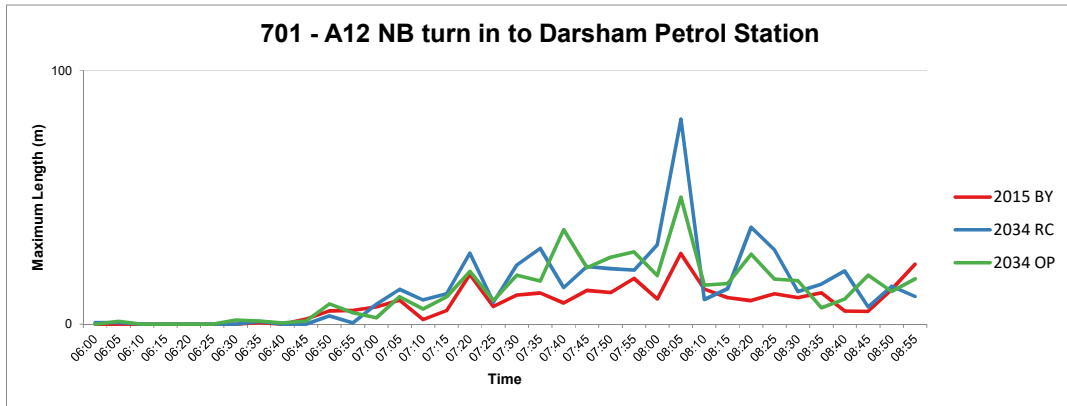

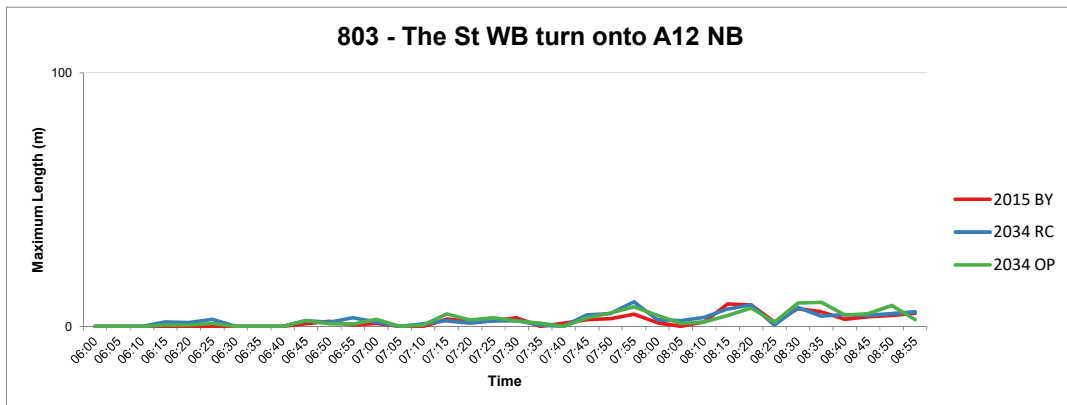
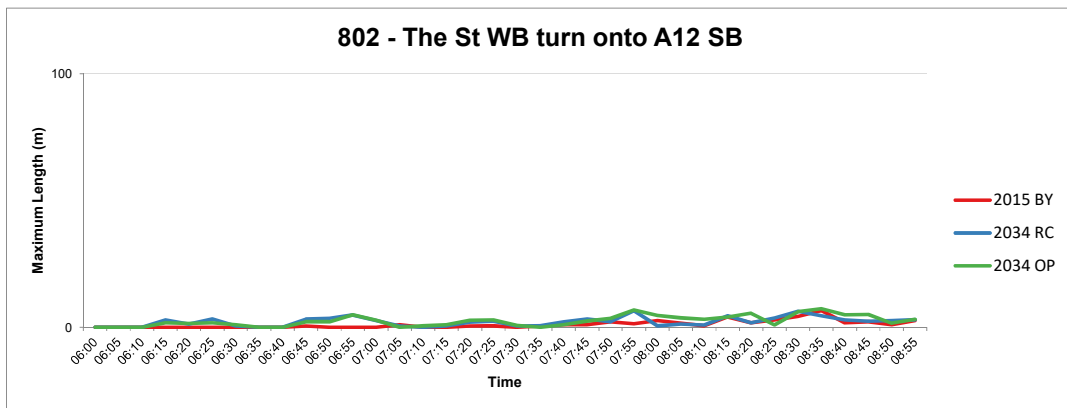
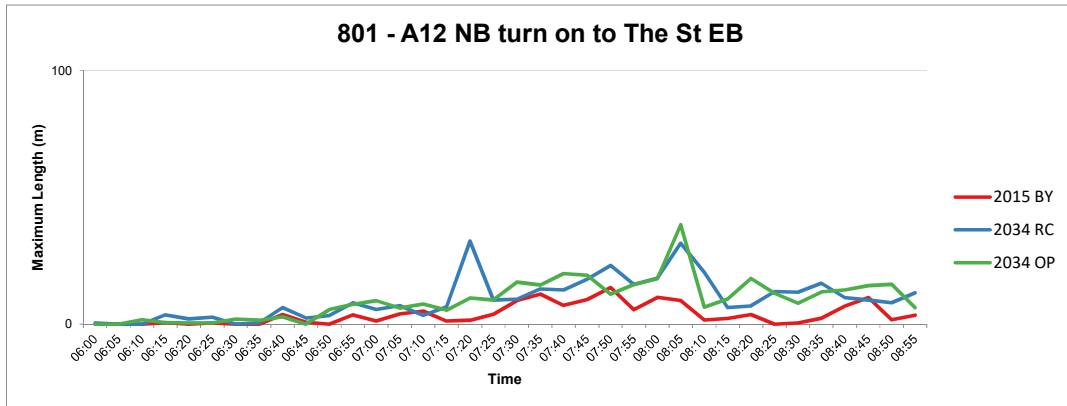

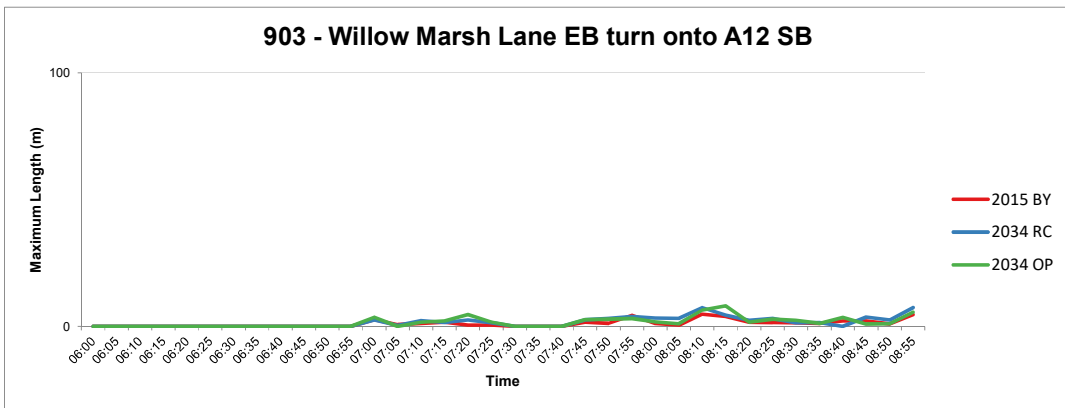
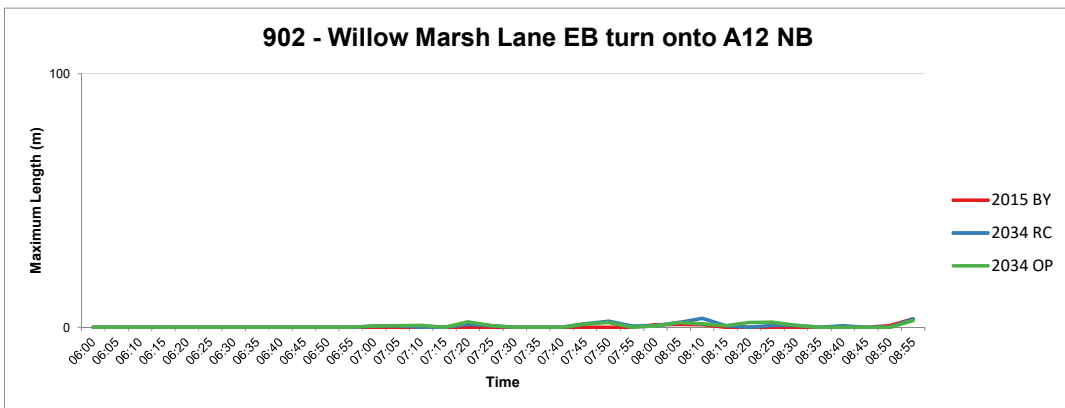
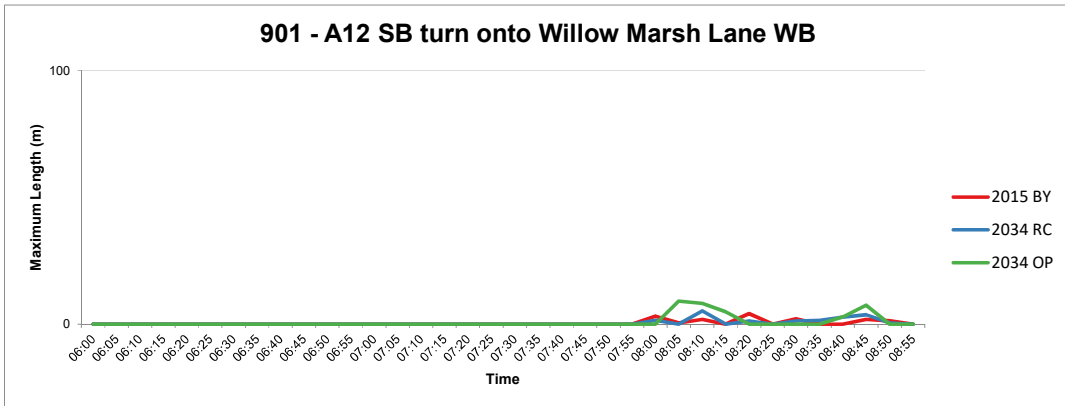

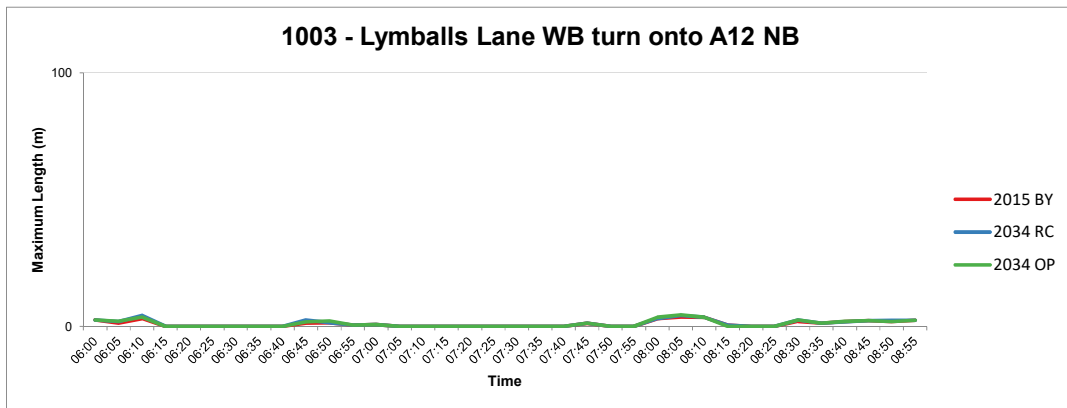
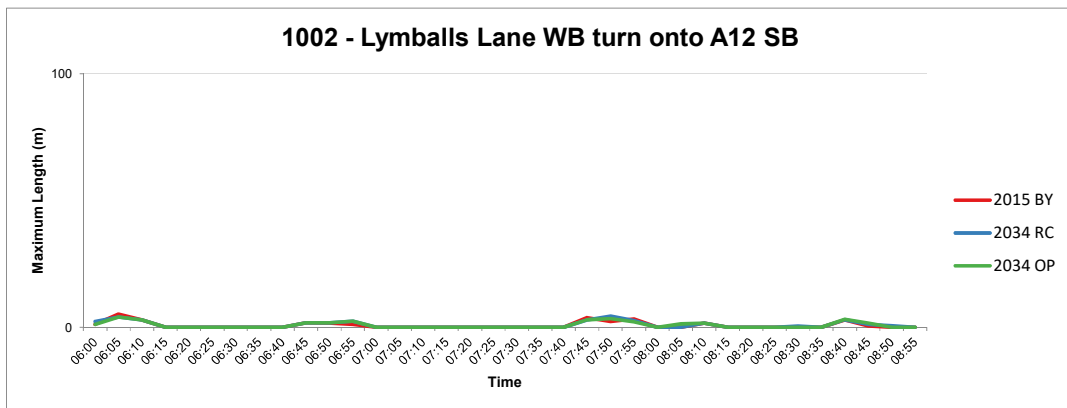
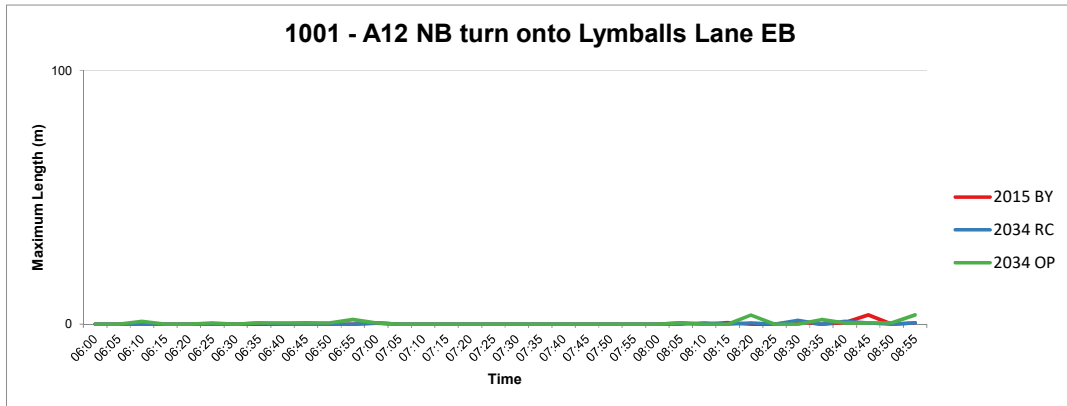

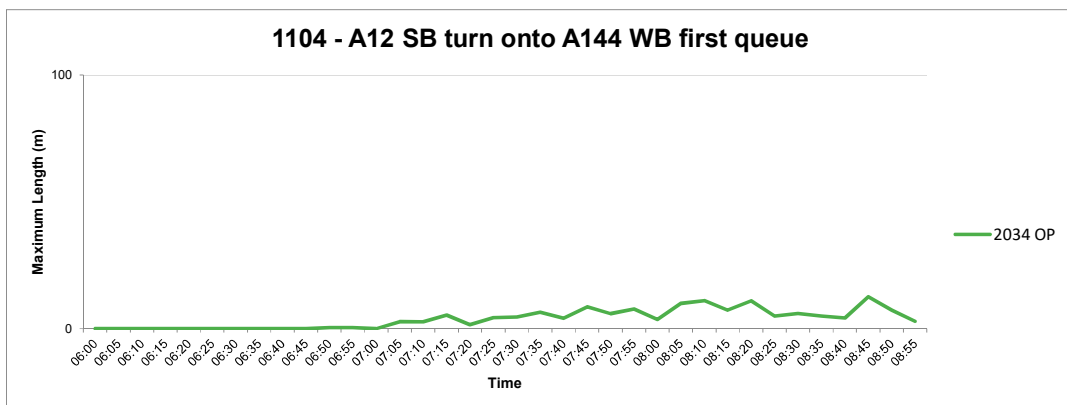
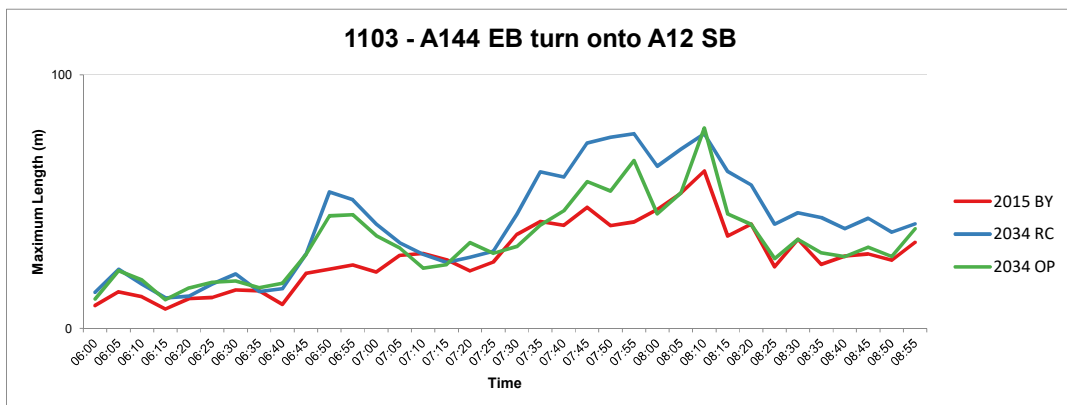
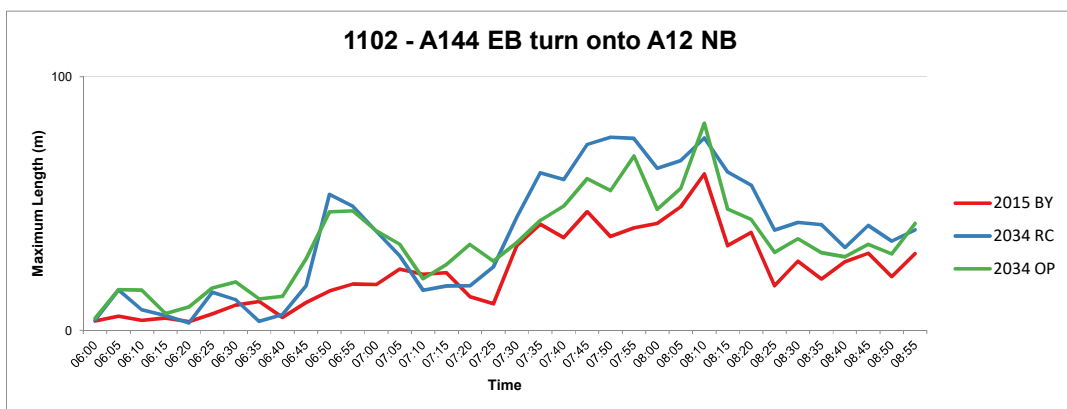
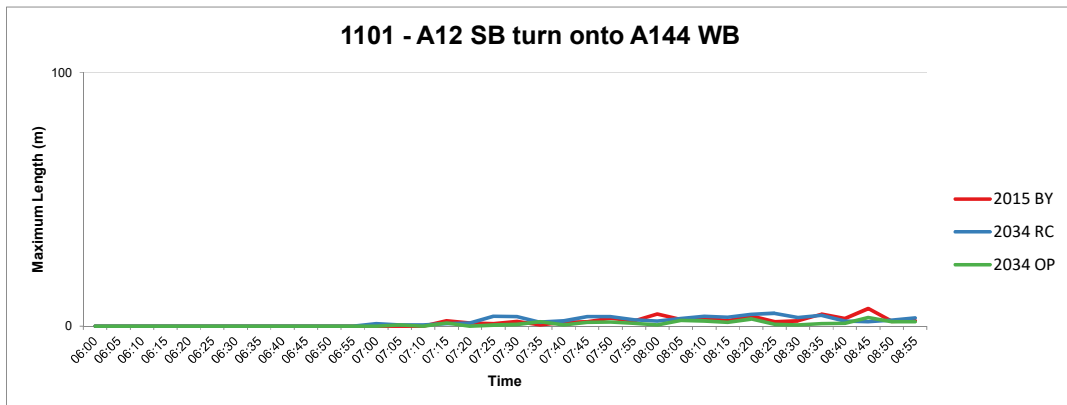

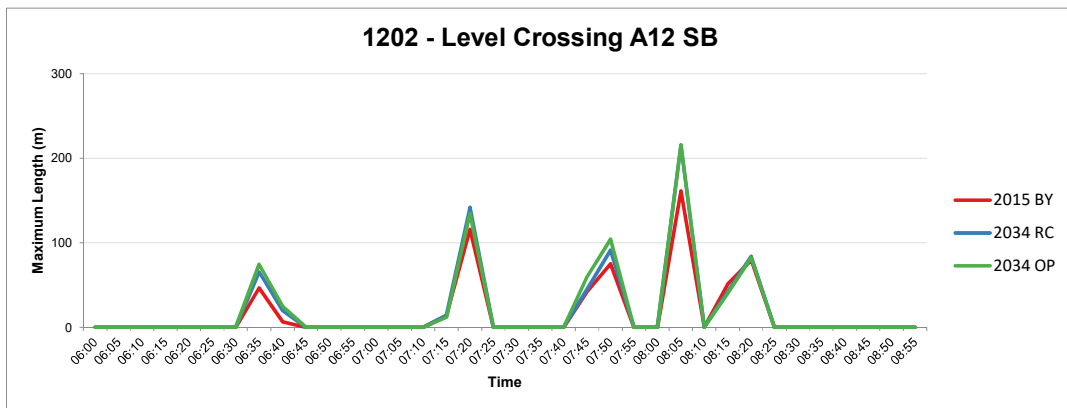
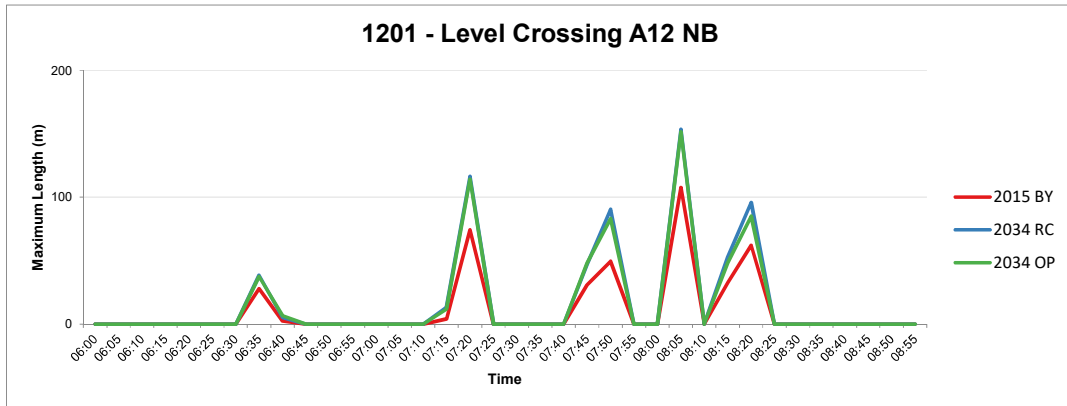

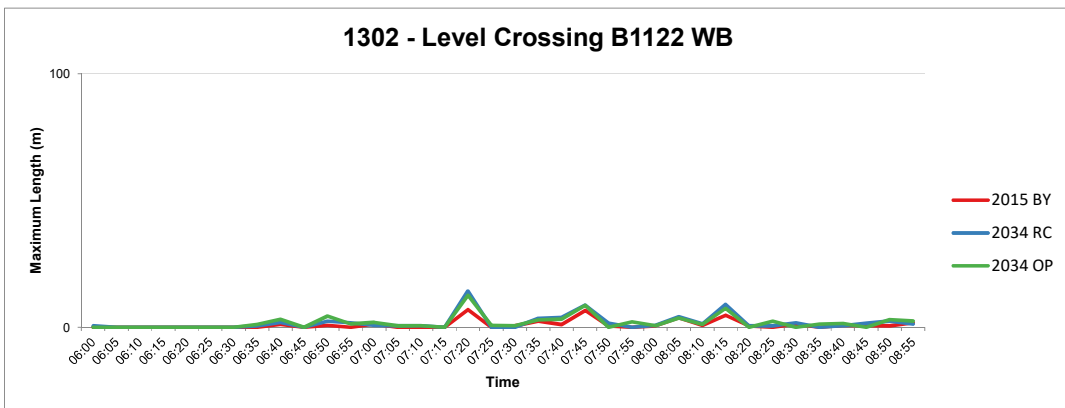
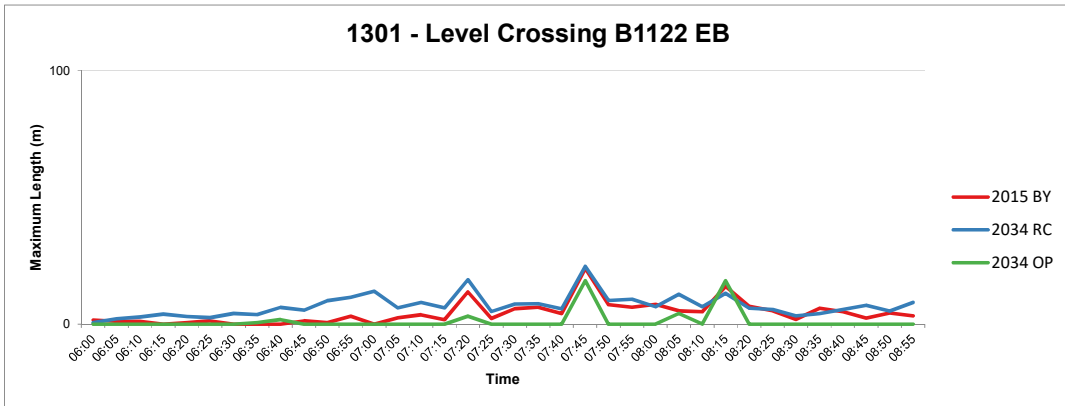



Queue Comparison
PM
Maximum Length Summary
Maximum Length (m)

	2015 BY	2034 RC	2034 OP
301 - A12 NB turn onto High Stre	2.1	1.6	2.7
302 - A12 SB turn onto High Stre	51.0	107.5	69.7
303 - High Street(A1120) EB turn	15.9	24.2	27.4
304 - High Street(A1120) EB turn	9.4	12.0	16.0
401 - A12 NB turn onto B1122 E	7.9	14.9	22.1
402 - B1122 WB turn onto A12 S	41.0	82.6	19.8
403 - B1122 WB turn onto A12 N	39.5	81.1	20.2
404 - A12 SB turn onto B1122 E	0.0	8.3	54.7
501 - A12 NB turn onto Westleto	4.4	10.5	6.7
502 - Westleton Road WB turn o	9.9	14.3	12.3
503 - Westleton Road WB turn o	7.2	10.9	11.1
601 - Darsham Petrol Station tur	11.2	16.5	16.5
602 - Darsham Petrol Station tur	11.5	17.9	17.0
701 - A12 NB turn in to Darsham	26.1	61.6	55.6
801 - A12 NB turn on to The St E	16.1	53.1	49.6
802 - The St WB turn onto A12 S	10.1	13.7	12.3
803 - The St WB turn onto A12 N	13.1	14.2	12.6
901 - A12 SB turn onto Willow M	5.6	17.4	19.8
902 - Willow Marsh Lane EB turn	2.3	4.3	3.1
903 - Willow Marsh Lane EB turn	4.9	4.9	4.9
1001 - A12 NB turn onto Lymball	6.7	7.3	10.0
1002 - Lymballs Lane WB turn o	8.6	8.1	8.1
1003 - Lymballs Lane WB turn o	5.8	5.0	5.5
1101 - A12 SB turn onto A144 W	9.3	3.9	2.1
1102 - A144 EB turn onto A12 N	32.0	47.9	43.7
1103 - A144 EB turn onto A12 S	32.8	48.4	41.0
1104 - A12 SB turn onto A144 W	B first queue		8.9
1201 - Level Crossing A12 NB	159.0	183.5	181.7
1202 - Level Crossing A12 SB	95.7	143.5	138.0
1301 - Level Crossing B1122 EB	10.0	11.1	13.2
1302 - Level Crossing B1122 WB	18.1	19.9	21.4
1401 - PandR Roundabout A12 NB			
1402 - PandR Rouandabout PandR Access			
1403 - PandR Roundabout A12 SB			
904 - PandR Access SB turn onto Willow Marsh Lane WB			
905 - Willow Marsh Lane EB turn onto PandR Access NB			
906 - Willow Marsh Lane EB turn onto PandR Access SB			

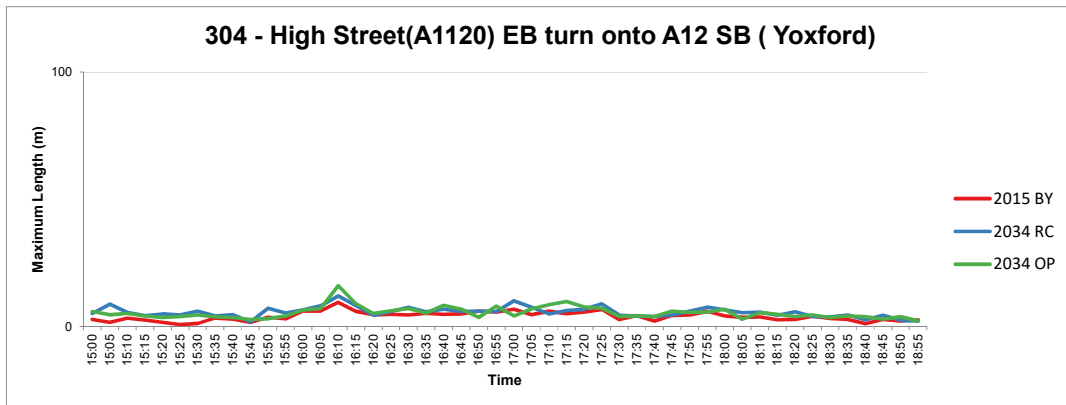
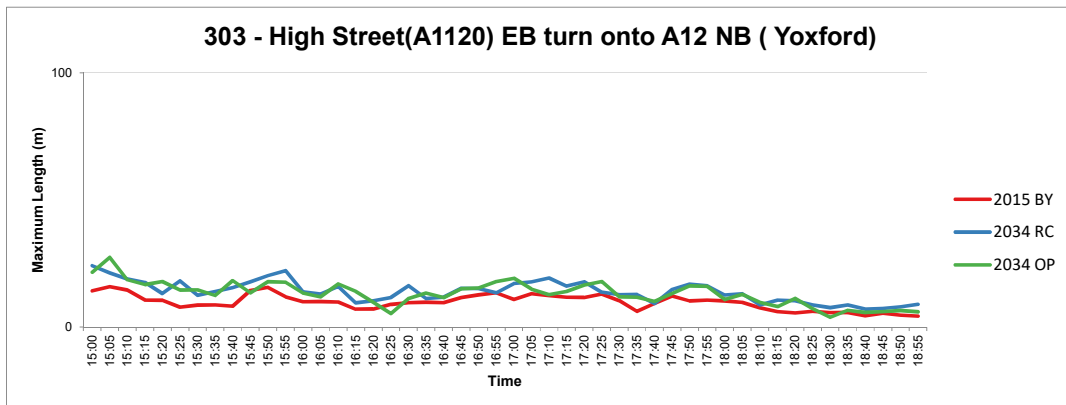
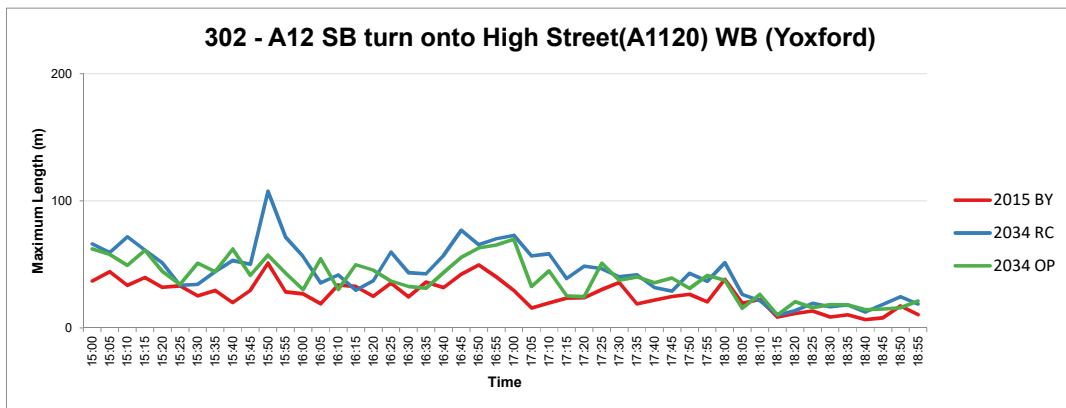
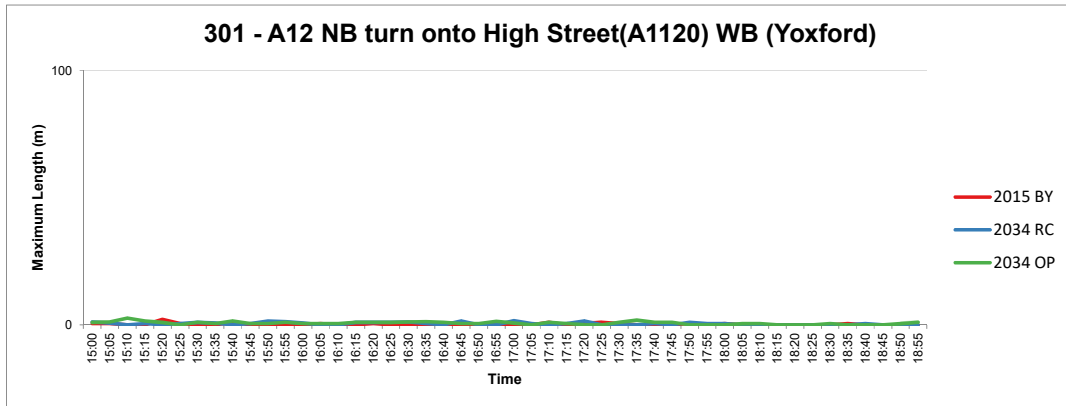

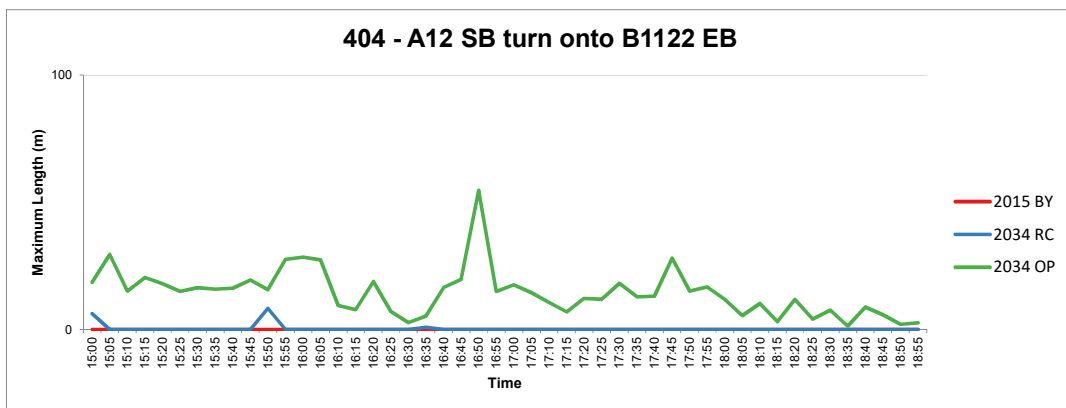
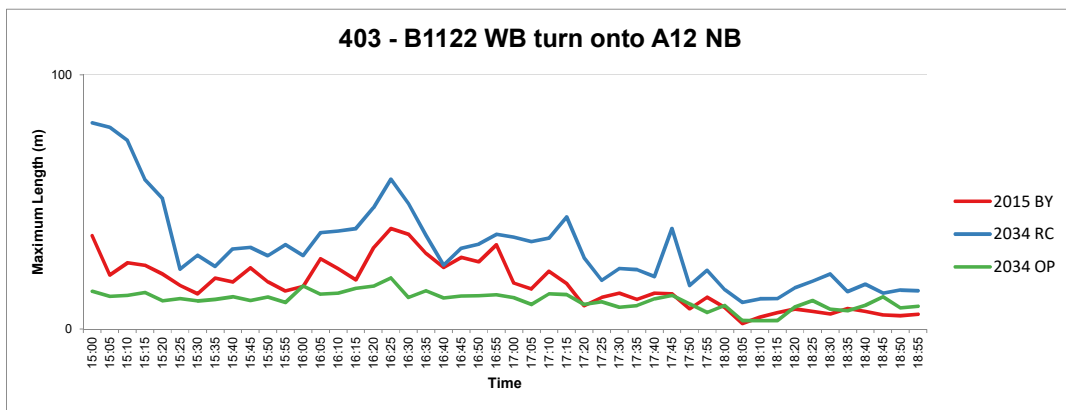
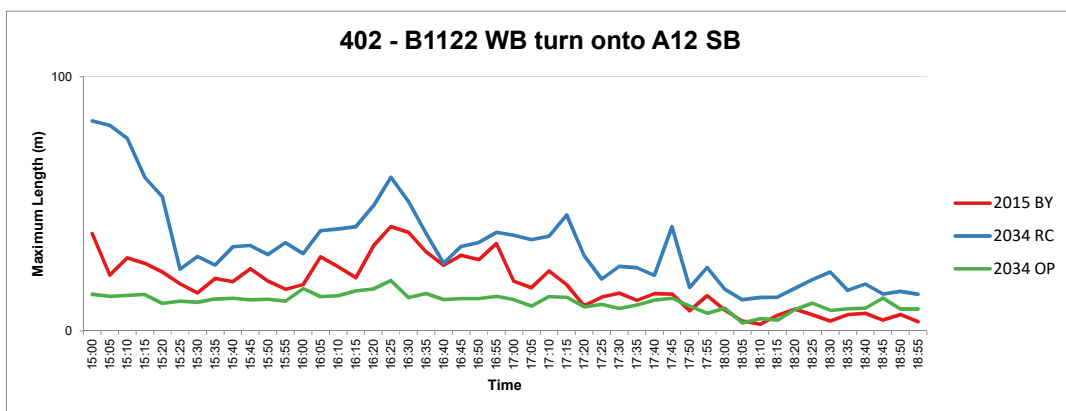
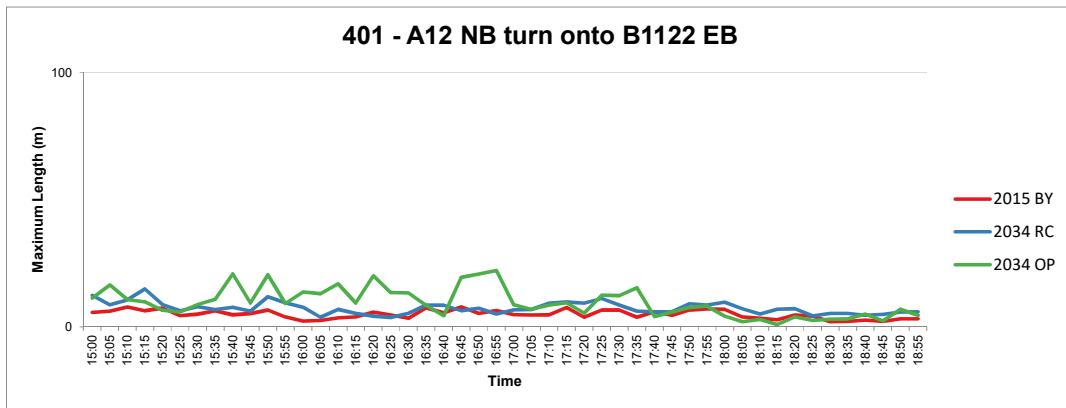

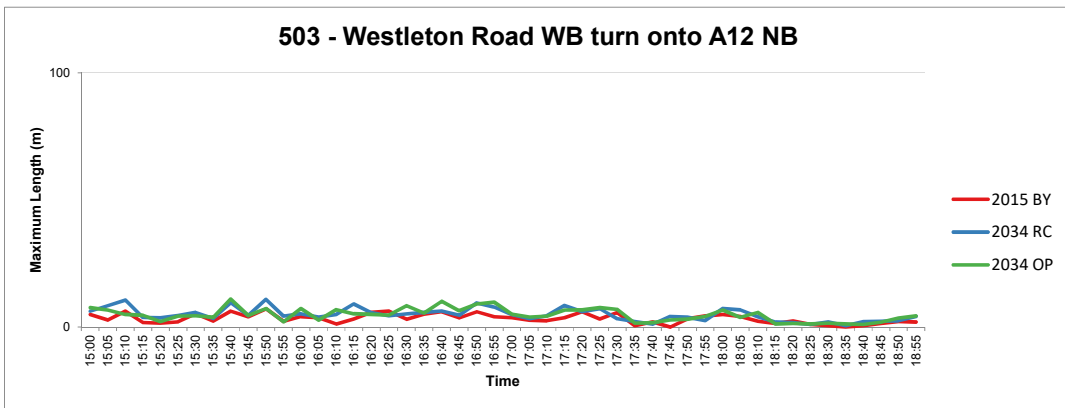
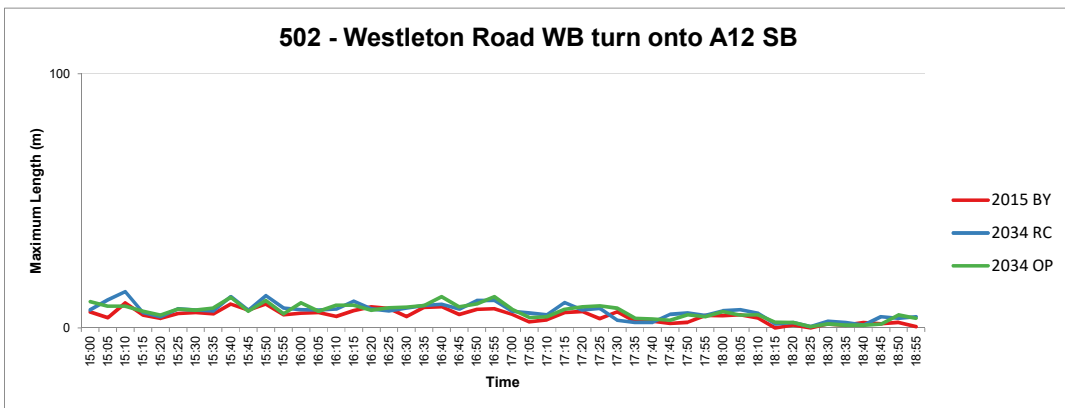
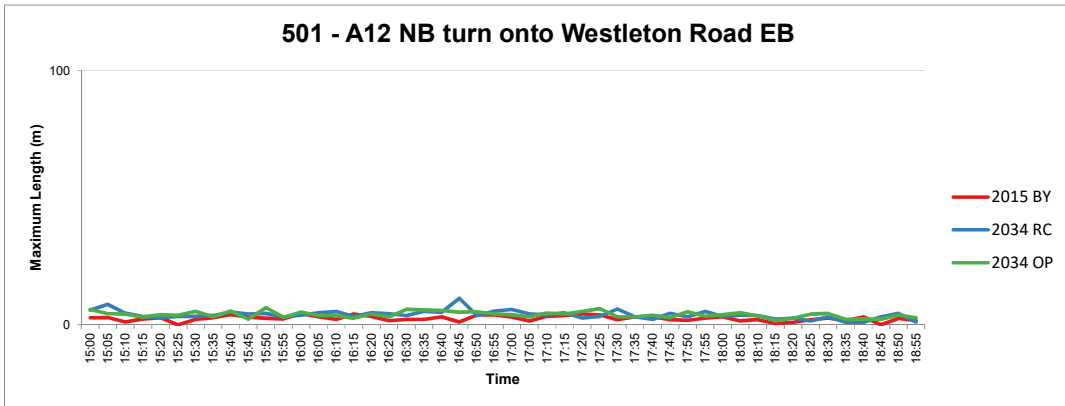



601 - Darsham Petrol Station turn onto A12 SB

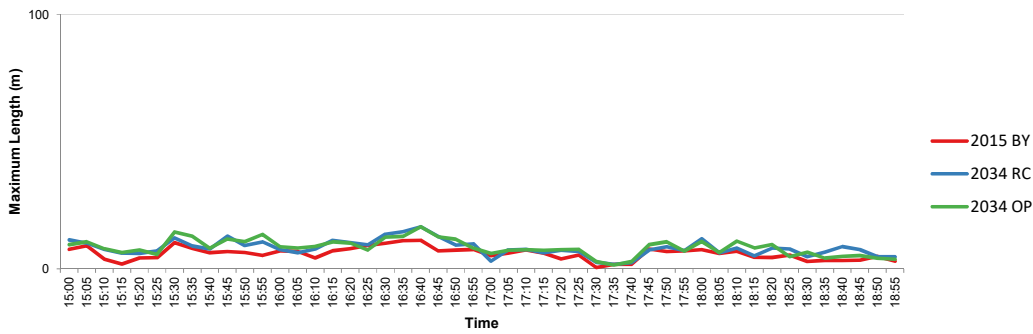

602 - Darsham Petrol Station turn onto A12 NB

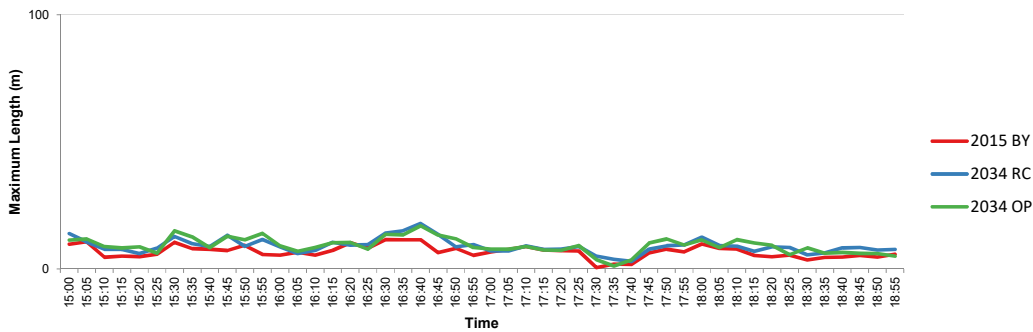

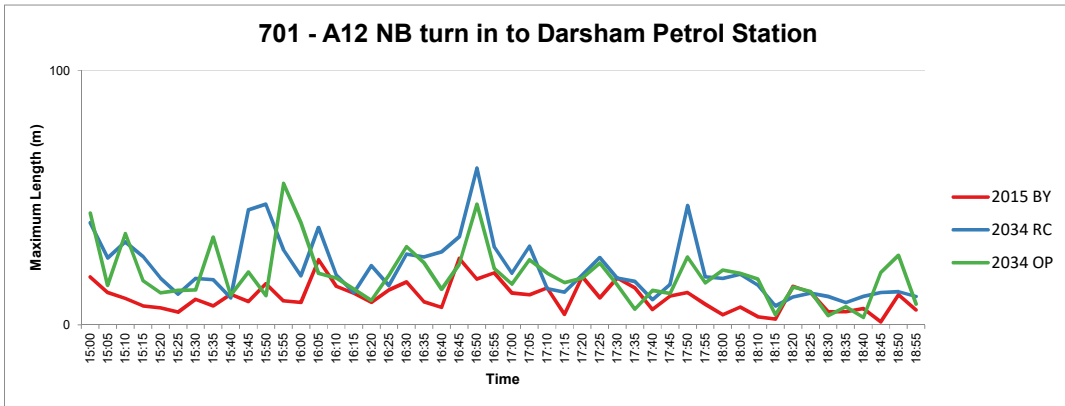

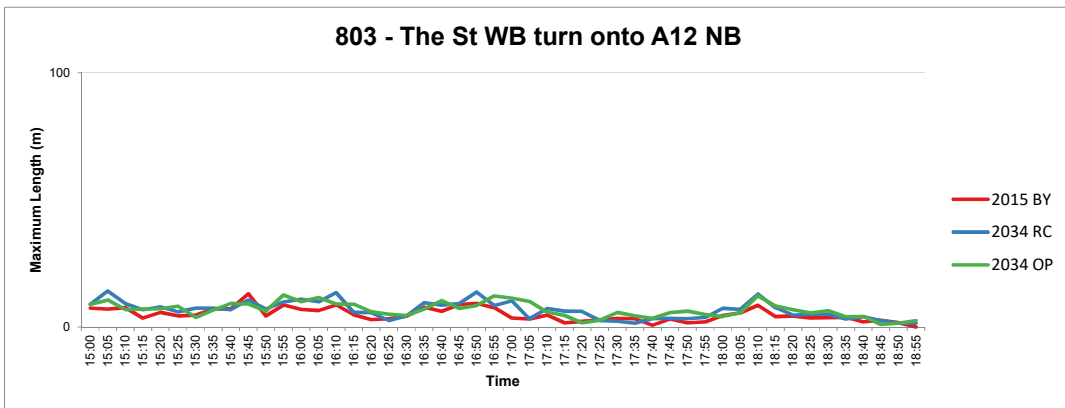
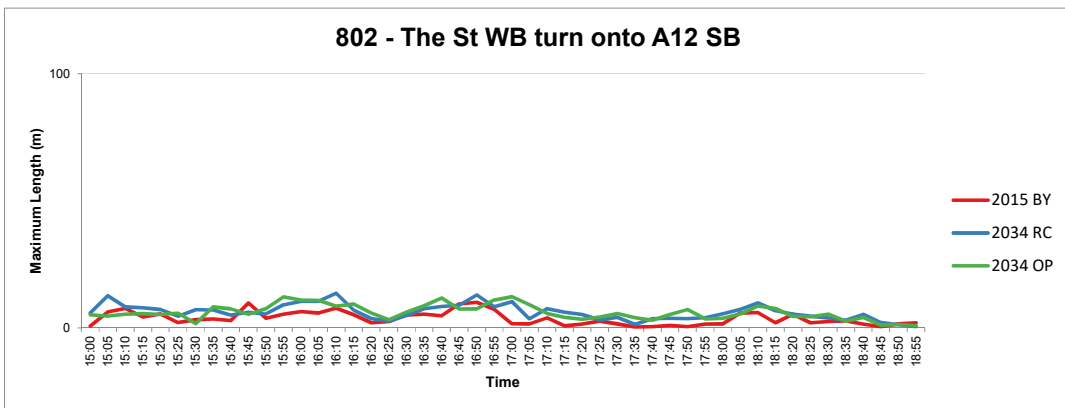
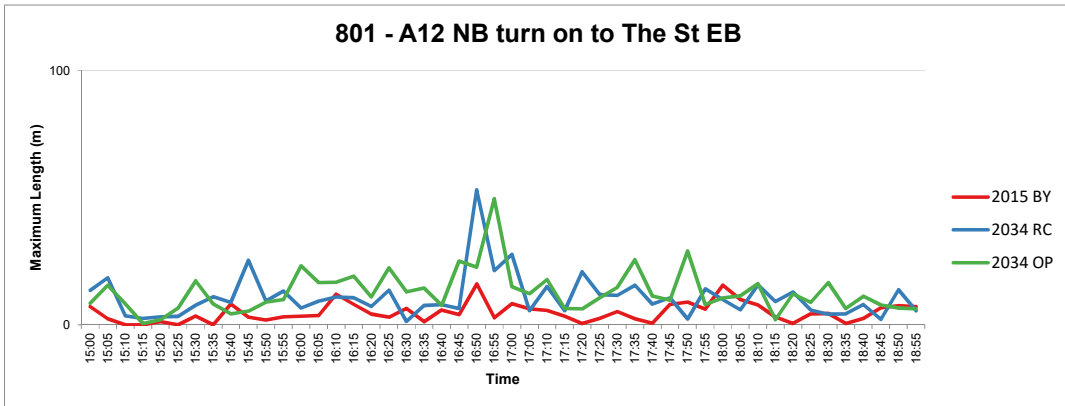

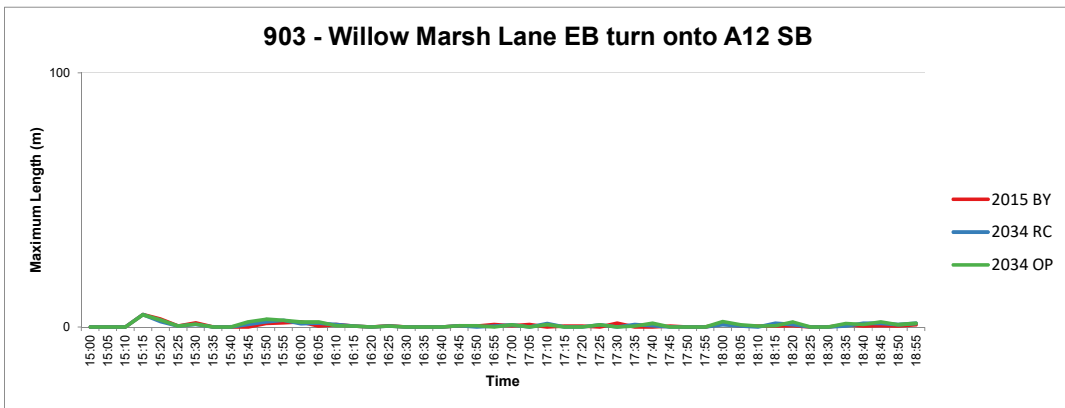
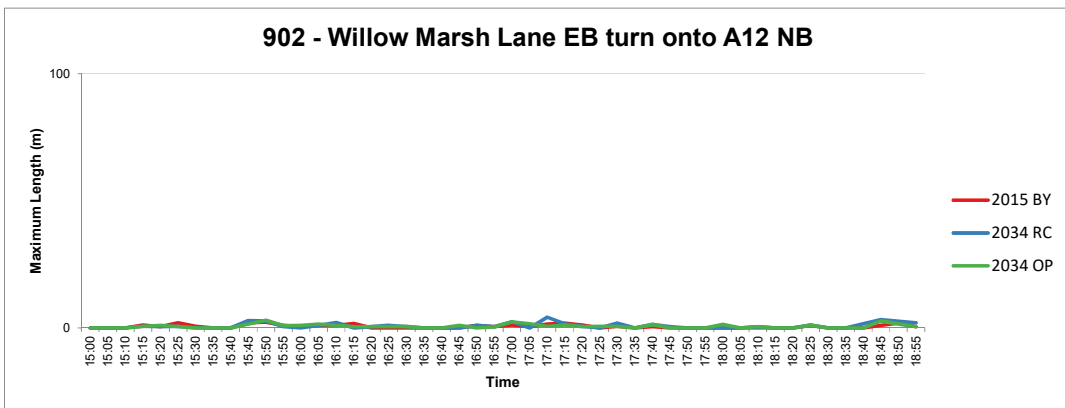
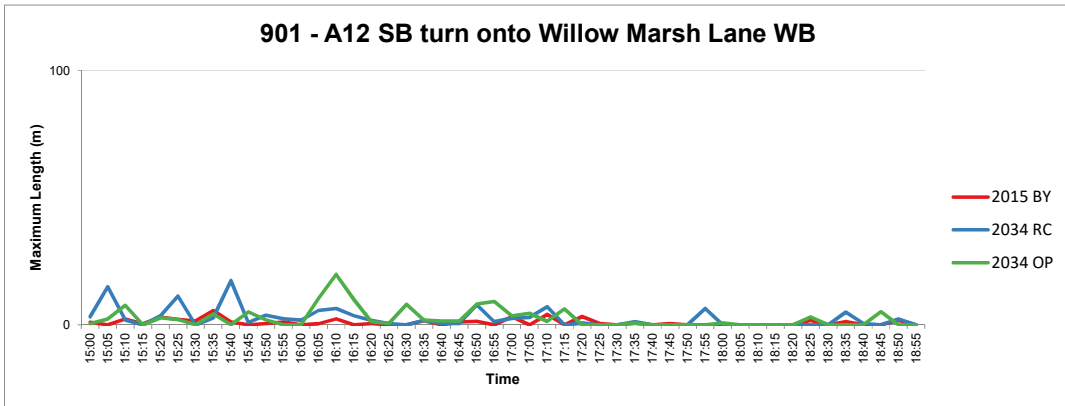

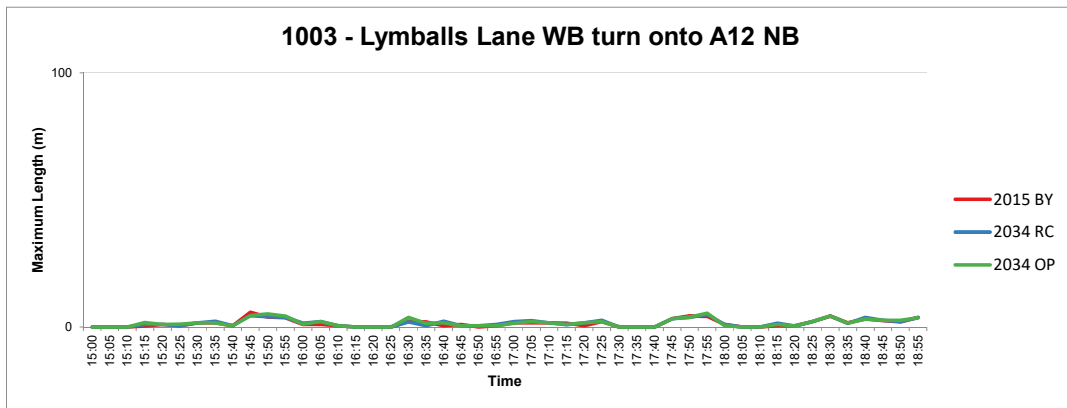
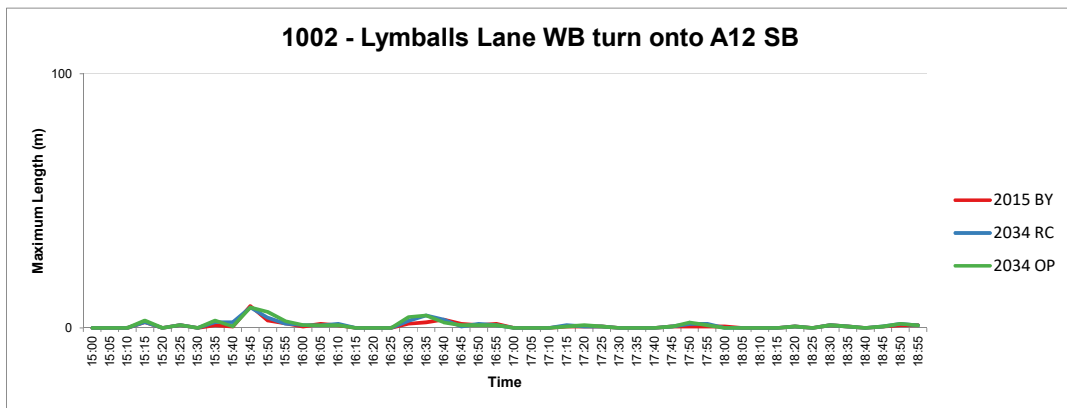
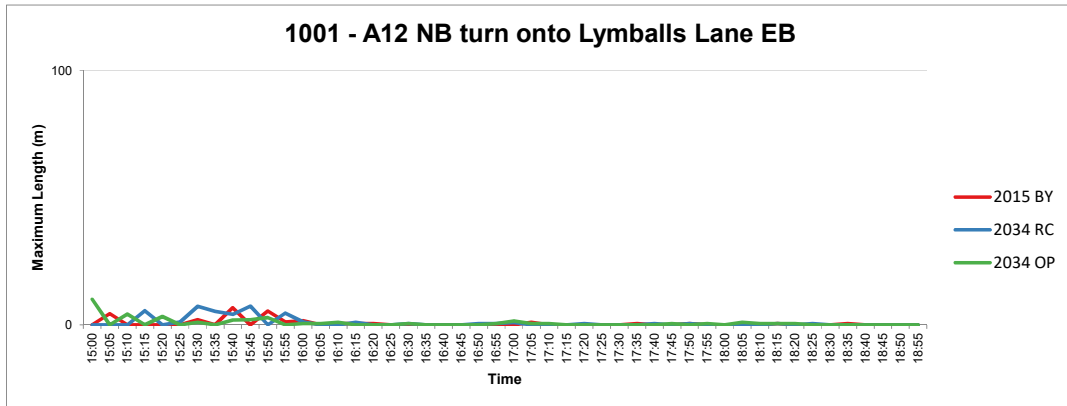

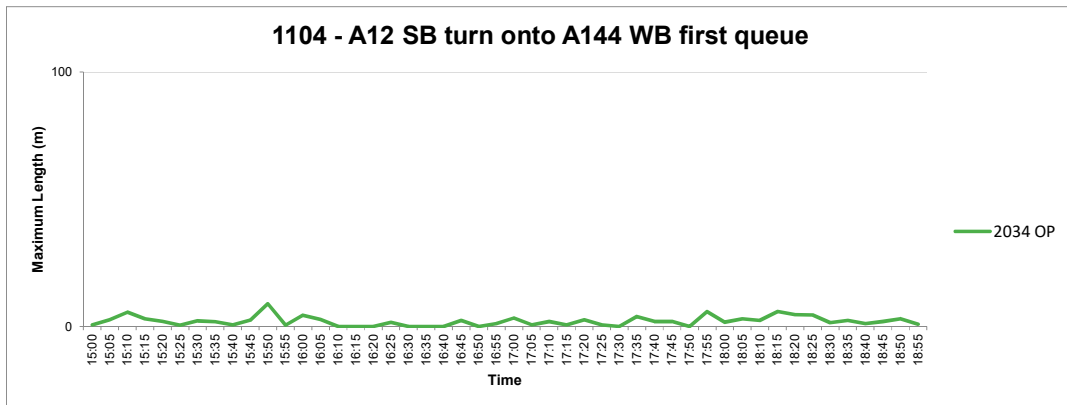
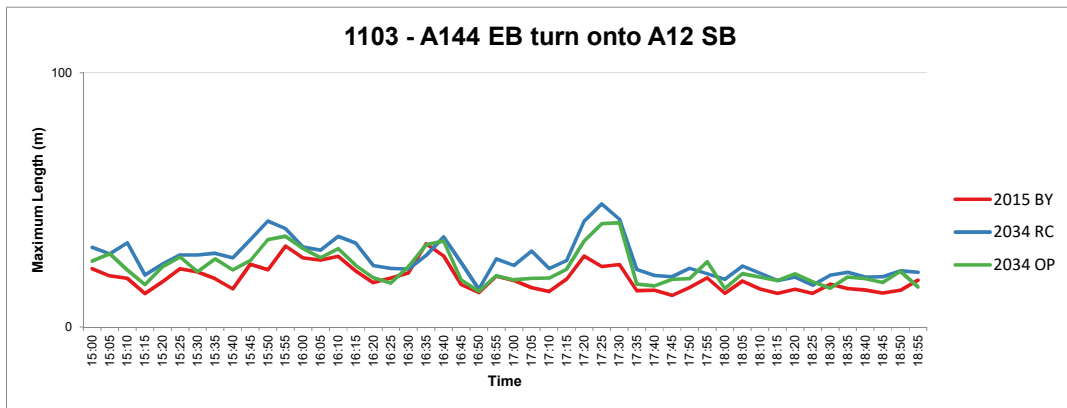
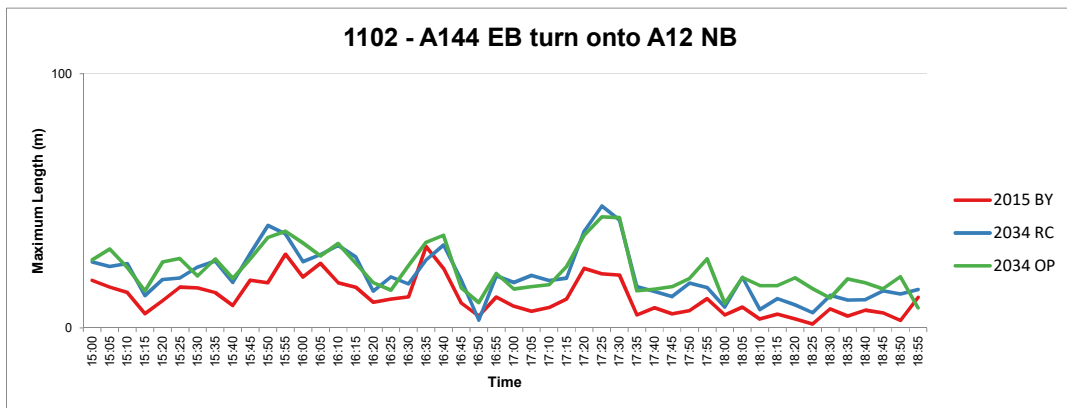
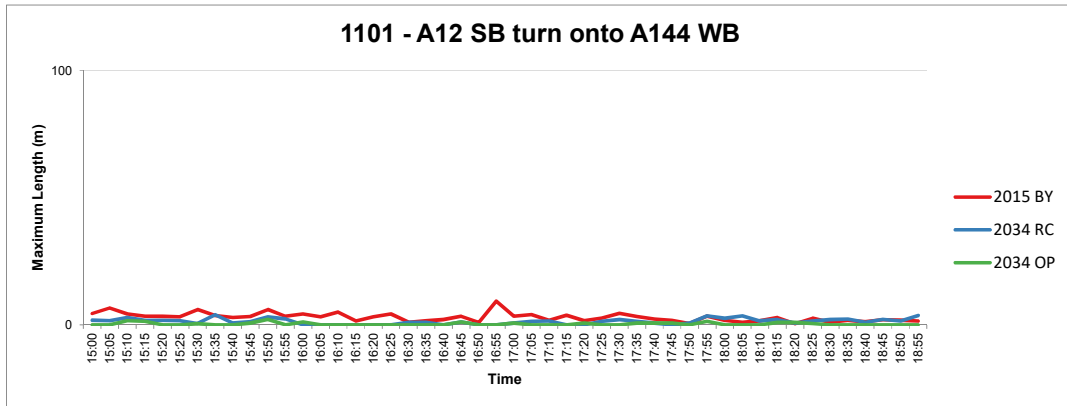

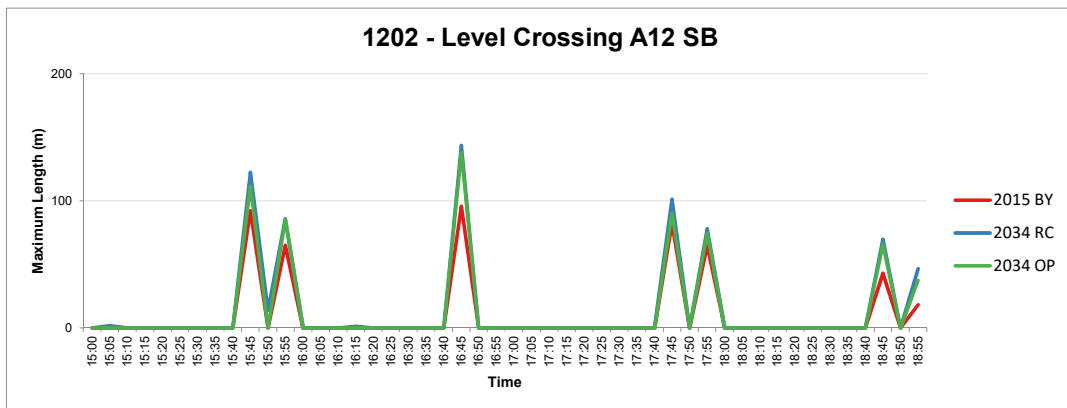
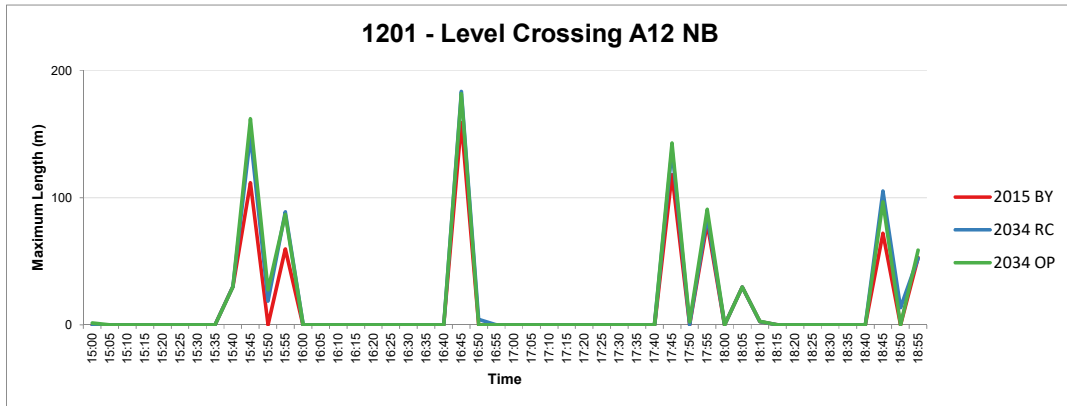

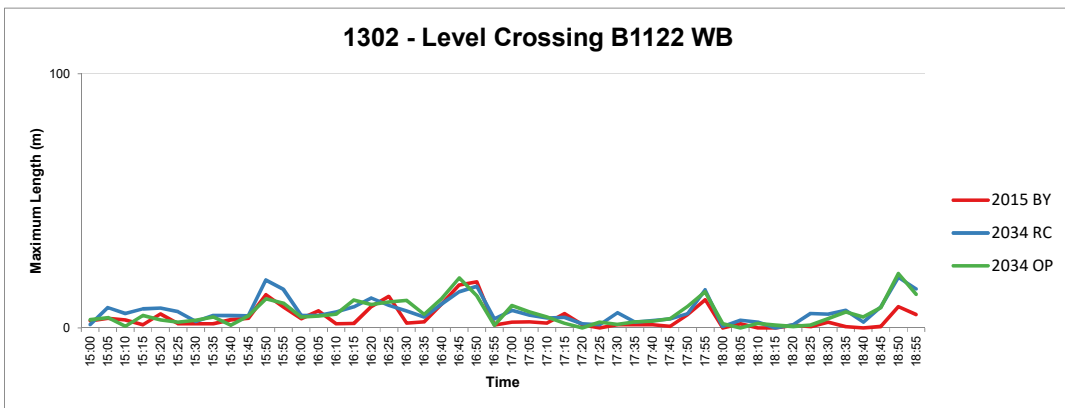
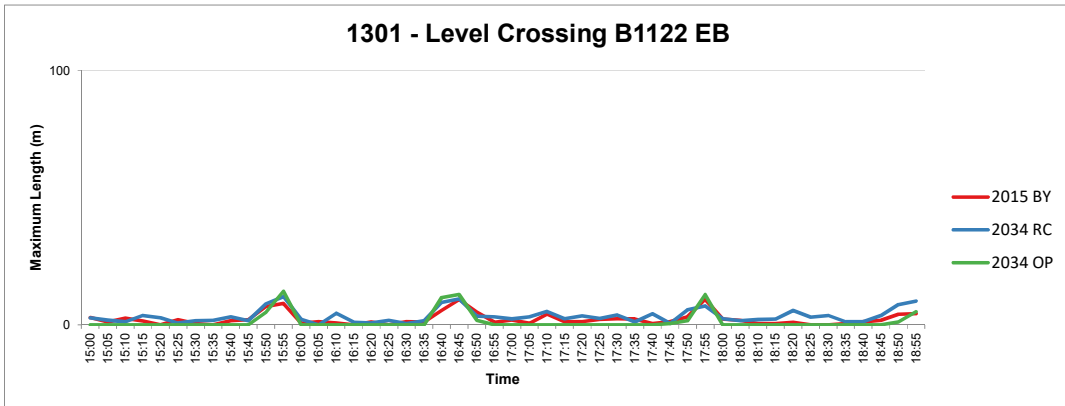

Appendix F



JUNCTION MITIGATION DESIGNS

DO NOT SCALE

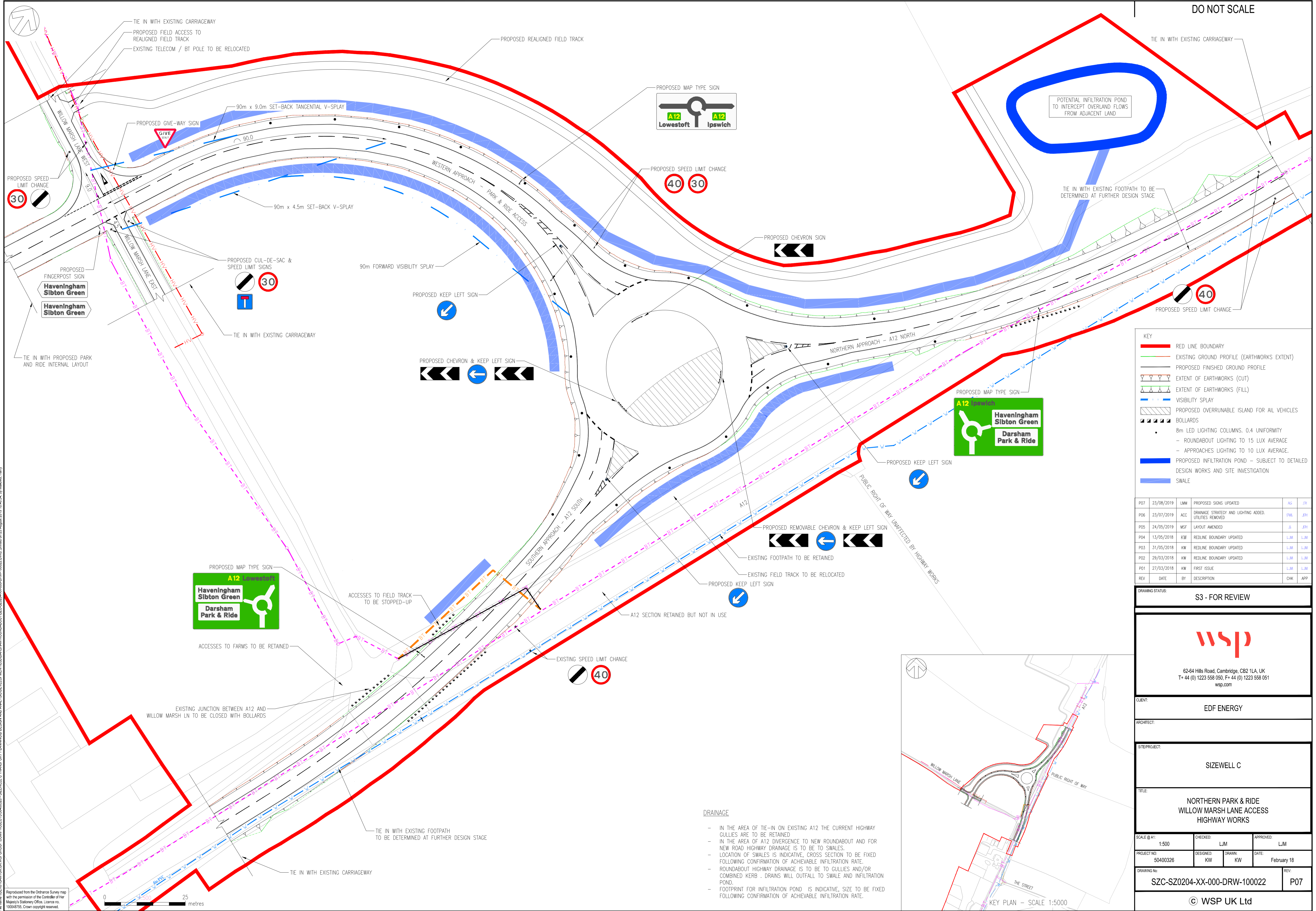

KEY

- RED LINE BOUNDARY
- EXISTING GROUND PROFILE (EARTHWORKS EXTENT)
- PROPOSED FINISHED GROUND PROFILE
- EXTENT OF EARTHWORKS (CUT)
- EXTENT OF EARTHWORKS (FILL)
- VISIBILITY SPLAY
- PROPOSED OVERRUNNABLE ISLAND FOR AIL VEHICLES
- BOLLARDS
- 8m LED LIGHTING COLUMNS, 0.4 UNIFORMITY
 - ROUNDABOUT LIGHTING TO 15 LUX AVERAGE
 - APPROACHES LIGHTING TO 10 LUX AVERAGE.
- PROPOSED INFILTRATION POND - SUBJECT TO DETAILED DESIGN WORKS AND SITE INVESTIGATION
- SWALE

REV	DATE	BY	DESCRIPTION	CHK	APP
P07	23/08/2019	LJM	PROPOSED SIGNS UPDATED	AG	JH
P06	23/07/2019	ACC	DRAINAGE STRATEGY AND LIGHTING ADDED, UTILITIES REMOVED	DWL	JH
P05	24/05/2019	MSF	LAYOUT AMENDED	J	JH
P04	13/05/2018	KW	REDLINE BOUNDARY UPDATED	LJM	LJM
P03	31/05/2018	KW	REDLINE BOUNDARY UPDATED	LJM	LJM
P02	29/03/2018	KW	REDLINE BOUNDARY UPDATED	LJM	LJM
P01	27/03/2018	KW	FIRST ISSUE	LJM	LJM

DRAWING STATUS: **S3 - FOR REVIEW**

62-64 Hills Road, Cambridge, CB2 1LA, UK
T+ 44 (0) 1223 558 050, F+ 44 (0) 1223 558 051
wsp.com

CLIENT: **EDF ENERGY**

ARCHITECT:

SITE/PROJECT: **SIZEWELL C**

TITLE: **NORTHERN PARK & RIDE
WILLOW MARSH LANE ACCESS
HIGHWAY WORKS**

SCALE @ A1:	CHECKED:	APPROVED:
1:500	LJM	LJM
PROJECT NO:	DESIGNED:	DATE:
50400326	KW	February 18

DRAWING NO: **SZC-SZ0204-XX-000-DRW-100022** REV: **P07**

© WSP UK Ltd

DRAINAGE

- IN THE AREA OF TIE-IN ON EXISTING A12 THE CURRENT HIGHWAY GULLIES ARE TO BE RETAINED
- IN THE AREA OF A12 DIVERGENCE TO NEW ROUNDABOUT AND FOR NEW ROAD HIGHWAY DRAINAGE IS TO BE TO SWALES.
- LOCATION OF SWALES IS INDICATIVE, CROSS SECTION TO BE FIXED FOLLOWING CONFIRMATION OF ACHIEVABLE INFILTRATION RATE.
- ROUNDABOUT HIGHWAY DRAINAGE IS TO BE TO GULLIES AND/OR COMBINED KERB, DRAINS WILL OUTFALL TO SWALE AND INFILTRATION POND.
- FOOTPRINT FOR INFILTRATION POND IS INDICATIVE, SIZE TO BE FIXED FOLLOWING CONFIRMATION OF ACHIEVABLE INFILTRATION RATE.

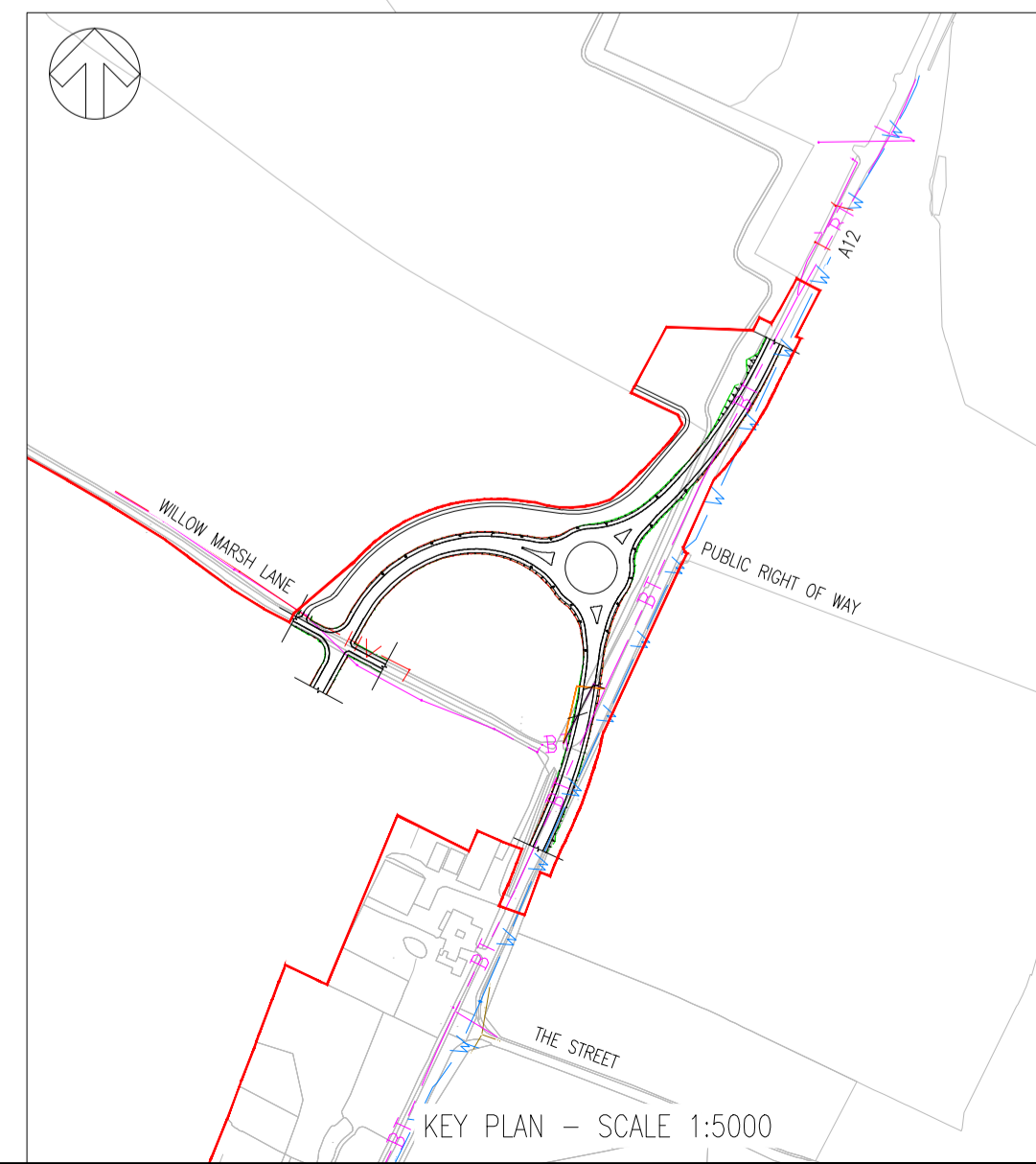

File name: I:\SERVO\UK\WSP\GROUP\COMP\PROJECTS\50400326 - SIZEWELL C TRANSPORT\PLANNING\DESIGN AND ANALYSIS\BID\REL\ELEMENTS\ROUNDABOUT\SZC-SZ0204-XX-000-DRW-100022.DWG, printed on 23 August 2019 16:42:54, by Mullins, Henry
 Reproduced from the Ordnance Survey map with the permission of the Controller of Her Majesty's Stationery Office. Licence no. 100048755. Crown copyright reserved.

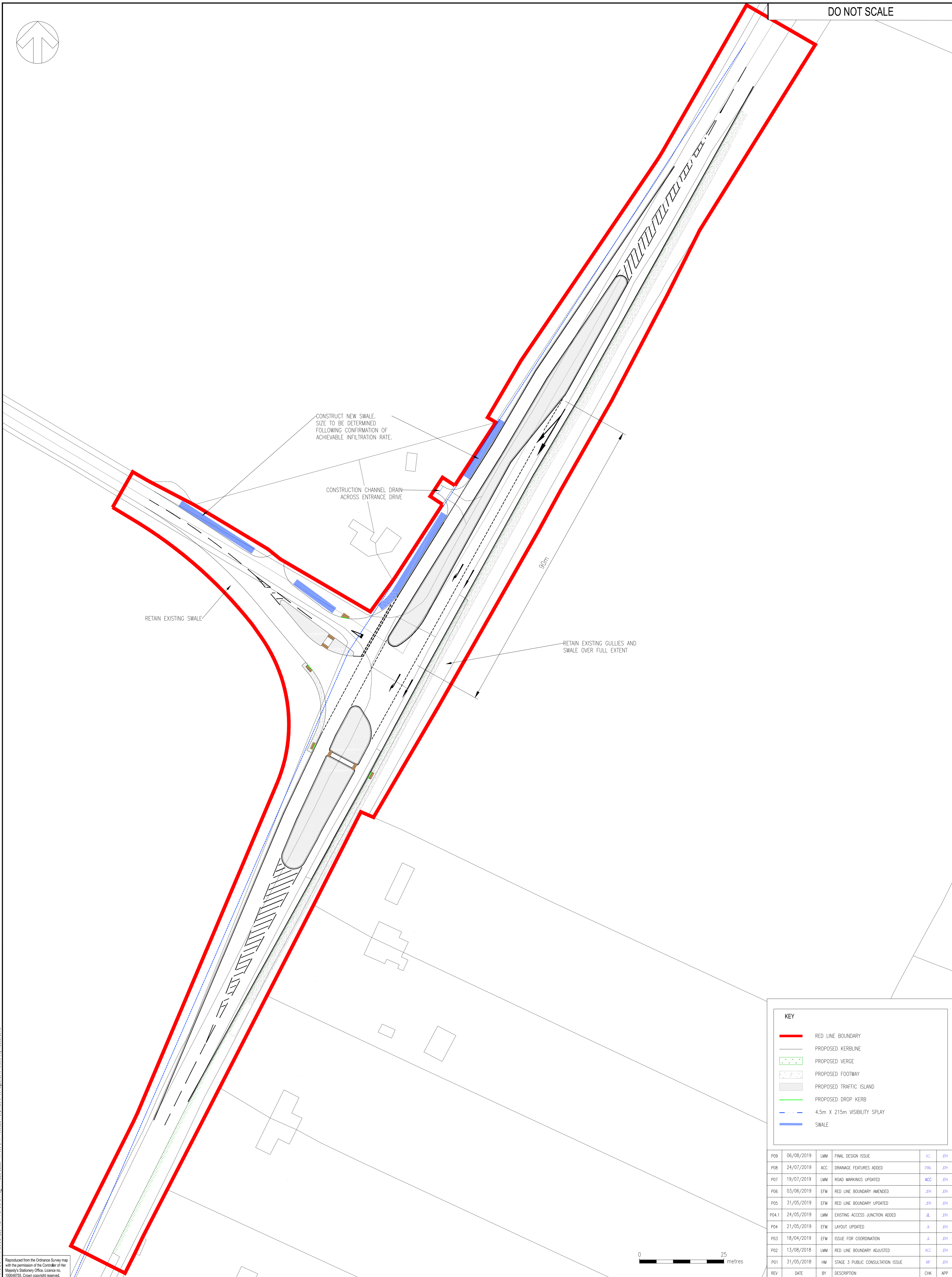
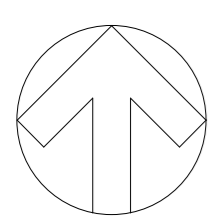

KEY

- RED LINE BOUNDARY
- PROPOSED KERBLINE
- PROPOSED VERGE
- PROPOSED FOOTWAY
- PROPOSED TRAFFIC ISLAND
- PROPOSED DROP KERB
- 4.5m X 215m VISIBILITY SPLAY
- SWALE

REV	DATE	BY	DESCRIPTION	CHK	APP
P09	06/08/2019	LMM	FINAL DESIGN ISSUE	ACC	JDH
P08	24/07/2019	ACC	DRAINAGE FEATURES ADDED	JDH	JDH
P07	19/07/2019	LMM	ROAD MARKINGS UPDATED	ACC	JDH
P06	03/06/2019	EFM	RED LINE BOUNDARY AMENDED	JDH	JDH
P05	31/05/2019	EFM	RED LINE BOUNDARY UPDATED	JDH	JDH
P04.1	24/05/2019	LMM	EXISTING ACCESS JUNCTION ADDED	JL	JDH
P04	21/05/2019	EFM	LAYOUT UPDATED	JL	JDH
P03	18/04/2019	EFM	ISSUE FOR COORDINATION	JL	JDH
P02	13/08/2018	LMM	RED LINE BOUNDARY ADJUSTED	ACC	JDH
P01	31/05/2018	HW	STAGE 3 PUBLIC CONSULTATION ISSUE	WF	JDH



Reproduced from the Ordnance Survey map with the permission of the Controller of Her Majesty's Stationery Office. Licence no. 100048755. Crown copyright reserved.

<p>DRAWING STATUS:</p> <p style="text-align: center; font-weight: bold;">S3 - FOR REVIEW</p>	<p>62-64 Hills Road Cambridge CB2 1LA, UK</p> <p>T+ 44 (0) 1223 558 050 F+ 44 (0) 1223 558 051 wsp.com</p>	<p>CLIENT:</p> <p style="text-align: center; font-weight: bold;">EDF ENERGY</p> <p>ARCHITECT:</p>	<p>PROJECT:</p> <p style="text-align: center; font-weight: bold;">SIZEWELL C TRANSPORT PLANNING</p> <p>TITLE:</p> <p style="text-align: center; font-weight: bold;">A12 / A144 PROPOSED HIGHWAY LAYOUT</p>	<p>SCALE @ A1:</p> <p style="text-align: center; font-weight: bold;">1:500</p> <p>PROJECT No:</p> <p style="text-align: center; font-weight: bold;">50400326</p> <p>DRAWING No:</p> <p style="text-align: center; font-weight: bold;">SZC-SZ0204-XX-000-DRW-100052</p>	<p>CHECKED:</p> <p style="text-align: center; font-weight: bold;">JDH</p> <p>DESIGNED:</p> <p style="text-align: center; font-weight: bold;">ACC</p> <p>DRAWN:</p> <p style="text-align: center; font-weight: bold;">EFM</p> <p>DATE:</p> <p style="text-align: center; font-weight: bold;">MAY 19</p> <p>APPROVED:</p> <p style="text-align: center; font-weight: bold;">JDH</p> <p>REV:</p> <p style="text-align: center; font-weight: bold;">P09</p>
© WSP UK Ltd					

File name: P:\6200326\SIZEWELL_C_TRANSPORT_PLANNING\DRAWING\OUTPUT\DATA\A12_A144_SZC-SZ0204-XX-000-DRW-100052.DWG, printed on 02 August 2019 15:02:31, by Nicola Lewis

Appendix G

SZC WORKER PROFILING



50400326-WSP-TP-TN-001

TO	Joe Hough (Suffolk County Council)	FROM	Sian Loveday (WSP)
DATE	17 December 2020	CONFIDENTIALITY	Confidential
SUBJECT	VISSIM modelling: Sizewell C Worker Profiling		

INTRODUCTION

Background

This Technical Note has been prepared to detail how SZC workers arriving at and departing from the proposed Sizewell C (SZC) site have been distributed around their anticipated shift start and end times for the purpose of flow profiling within VISSIM. By analysing observed worker distributions at the existing Hinkley Point C (HPC) site and applying these to the likely SZC shift patterns, the profile of arriving and departing workers has been derived at SZC, at Yoxford and at Martlesham.

Methodology

SZC worker entry and exit profiles have been derived in 15-minute intervals for use in the two SZC VISSIM models using the methodology set out below:

- 1 Derive existing 'typical' entry and exit worker profiles at HPC in 5-minute intervals, based on observed data;
- 2 Identify the SZC shift start and end times;
- 3 Apply the 'typical' entry and exit worker distributions from step 1 to each SZC shift from step 2 to provide an estimate of the SZC workers likely to be entering and exiting the site in each 5-minute interval;
- 4 Apply a travel time offset to shift the estimated SZC distribution so that it's appropriate for use at Yoxford and Martlesham respectively;
- 5 Apply the offset distribution to the hourly SZC worker trips sourced from the forecast VISUM scenarios to produce 15-minute SZC worker trip matrices suitable for VISSIM.

EXISTING HPC PROFILE AT SECURITY GATE

Data Obtained From HPC

HPC is the first new power station to be built in the UK in over 20 years. Currently under construction in Somerset, it provides the closest reflection of how SZC will operate through the construction phase. Therefore, to form a basis for deriving an arrival and departure profile for SZC, the following data was obtained from HPC.

ENTRY AND EXIT COUNTS

Workers at the HPC site are required to enter and exit the construction site through security gates which form the only access to the site. This enables monitoring of the number and identity of people working on site at any one time. The timestamps of construction workers travelling through the security gate at the HPC site were obtained for a full 24-hour period on a Tuesday in February 2020. At this point in time the HPC development was operating at the equivalent of the SZC Early Years scenario but is considered to provide a reasonable estimate of the distribution of workers entering/exiting for a typical shift regardless of the stage of construction.

The raw data was provided to the nearest second and presented as an arrival or departure. Table 1 below sets out the total number of entries and exits recorded.

Table 1 – Total Recorded Entries and Exits

Security Gate Movements	No. people
Entries	6,331
Exits	6,161
Total	12,492

SCHEDULED SHIFT PATTERNS

A list of shifts and their typical start and end times and the number of anticipated workers was also obtained from HPC. The HPC shift start and end times were all found to fall on the hour or half past the hour.

HPC Entry Profile

The HPC entry timestamps were aggregated in 5-minute intervals (i.e. 288 data points in 24-hours) and compared with the scheduled shift start times as shown in Figure 1. This graph illustrates the recorded security gate entries (green line) relative to the scheduled shift start times (purple bars). Note that the data is shown on separate vertical axes, with different scales

Figure 1 – HPC Recorded Security Gate Entries and Scheduled Shift Start Times

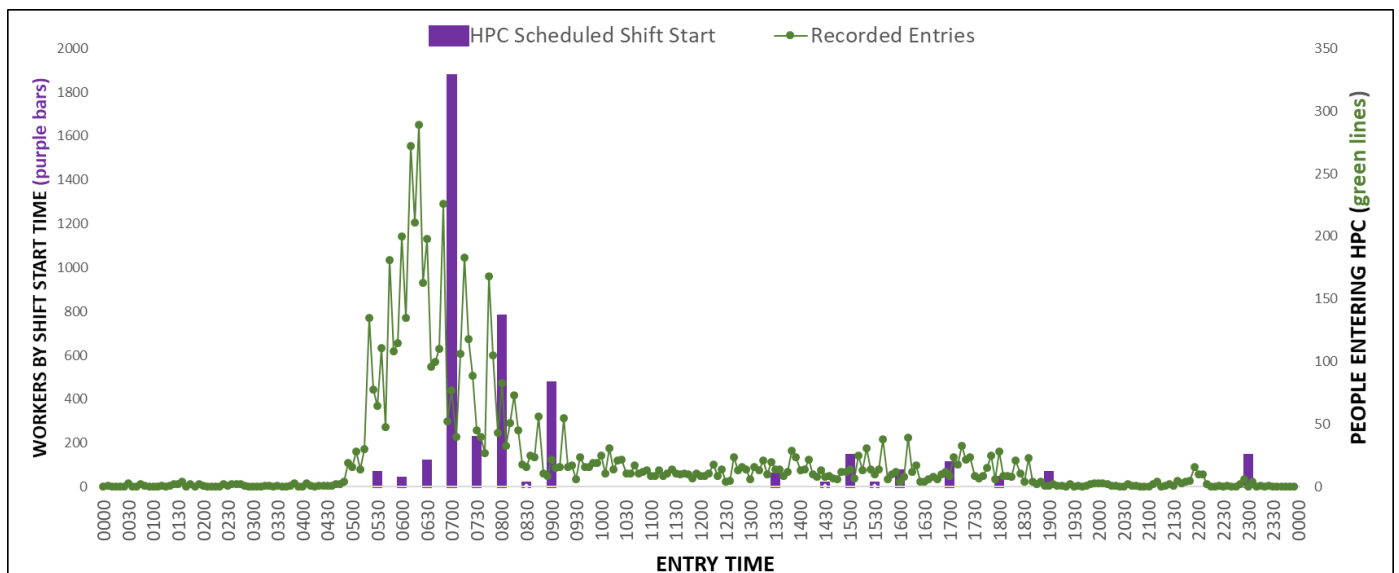
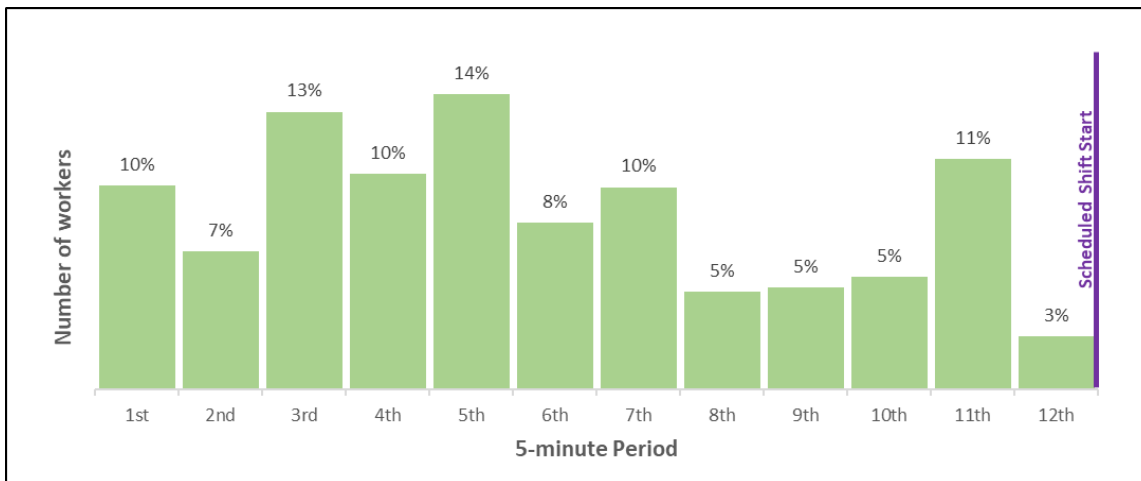

Figure 1 demonstrates that the most common shift start time is 07:00, when almost 2000 HPC workers are scheduled to begin their shifts. In the preceding hour and a half, only 189 workers are scheduled to begin their shift. Therefore, Figure 1 clearly shows that many workers arrive on site before their shift is scheduled to begin, as expected. It is estimated that the majority of workers arrive sometime during the hour prior to their scheduled start time.

This data has been used to produce an estimated distribution of worker arrivals ahead of a typical shift start and has been derived using the observed entries at HPC during the hour preceding 07:00 (i.e. from 06:00-07:00). Data has been aggregated in 5-minute intervals to allow travel time offsets to be applied later in the process. The resultant distribution is split into twelve 5-minute time segments leading up to the shift start time. Figure 2 below illustrates the estimated 'typical' entry distribution in advance of a shift beginning.

Figure 2 – Typical arrival distribution in advance of a shift



HPC Exit Profile

The HPC exit timestamps were also aggregated to 5-minute intervals (i.e. 288 data points in 24-hours) and compared with the HPC shift end times as shown in Figure 3. This graph illustrates the recorded security gate exits (orange line) relative to the scheduled shift end times (purple bars). Note that the data is shown on separate vertical axes, with different scales.

Figure 3 – HPC Recorded Security Gate Exits and Scheduled Shift End Times

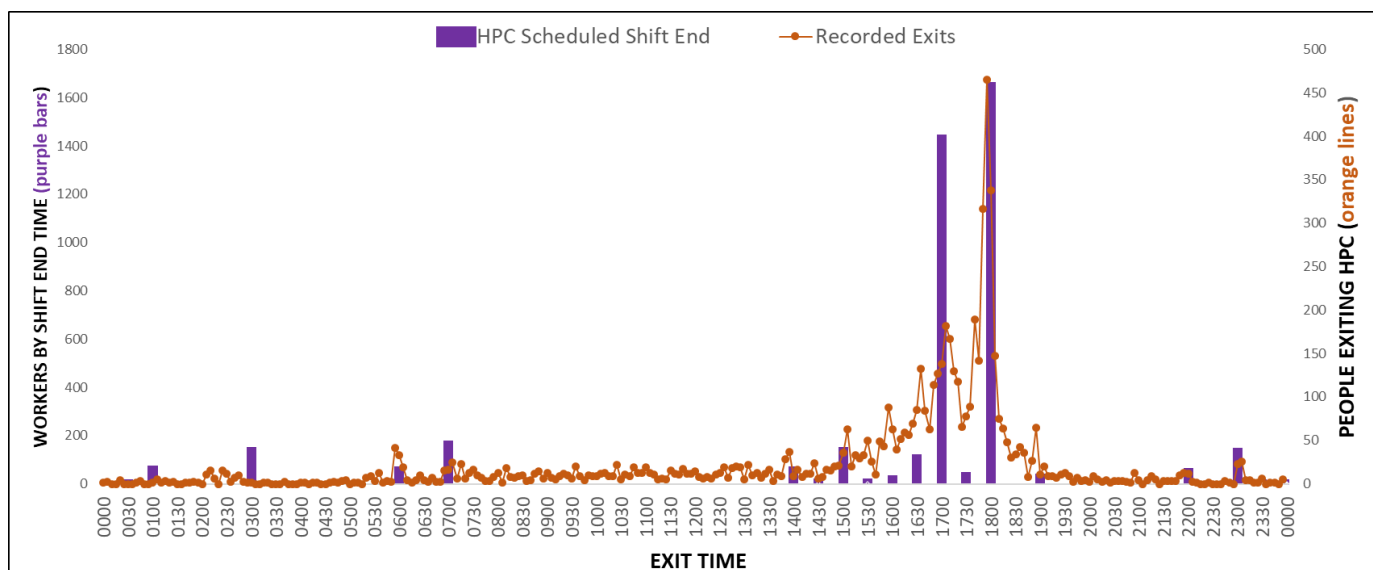
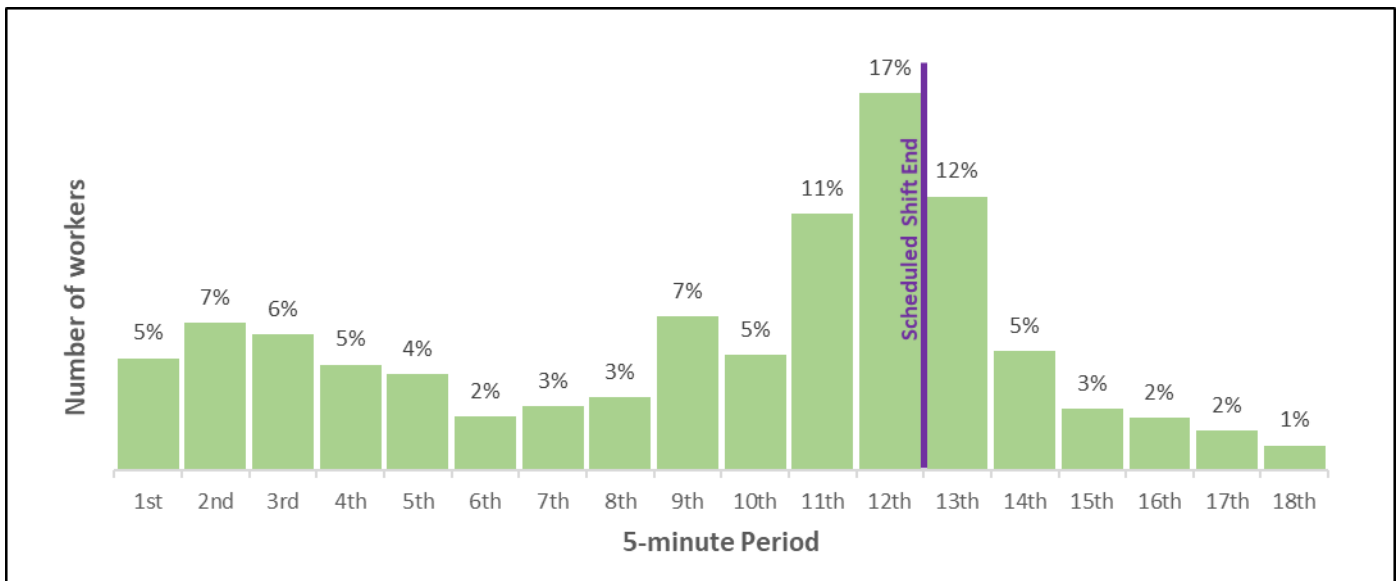

Figure 3 demonstrates that the majority of HPC workers are scheduled to finish their shift at either 17:00 or 18:00. Studying the patterns around the scheduled shift end time of 18:00, there is a clear spike in exits just before the scheduled finish time, with a less significant but still noticeable number of workers exiting both before and after this spike.

For this reason, the estimated departure distribution has been based on the hour prior to (capturing any workers leaving early) and the 30 minutes after the 18:00 shift end time. The 18:00 HPC shift end time was selected as a proxy for a typical distribution as it contains the greatest number of exiting workers and gives the clearest exit distribution after the shift end time.

An approximate distribution of worker departures around a typical shift end time has been derived using the observed exit data at HPC around the 18:00 shift end time. The distribution was based on the hour before and 30-minutes after the 18:00 shift end (i.e. from 17:00-18:30). The data has been aggregated in 5-minute intervals and the resultant distribution is therefore split into 18 time segments within the 90-minute period. Figure 4 below illustrates the estimated 'typical' exit distribution before and after a shift is due to end.

Figure 4 – Typical HPC Exit Profile



The estimated 'typical' worker entry and exit distributions (Figure 2 and Figure 4), provide a rough approximation for the level of arrival and departure time distribution that might be expected at a nuclear power station construction site. These distributions have been applied to the SZC shift times as detailed in the following chapter.

PREDICTED SZC WORKER PROFILE AT SECURITY GATE

SZC Scheduled Shift Patterns

Approximate SZC peak construction shift windows were provided by EDF. A trapezoidal distribution of start and end times has been assumed for each Sizewell C shift window, in line with the assumptions made for the VISUM modelling. The anticipated peak construction SZC shift start and end times are shown in Figure 5 and Figure 6 respectively.

Figure 5 - SZC Shift Start Times (Peak Construction)

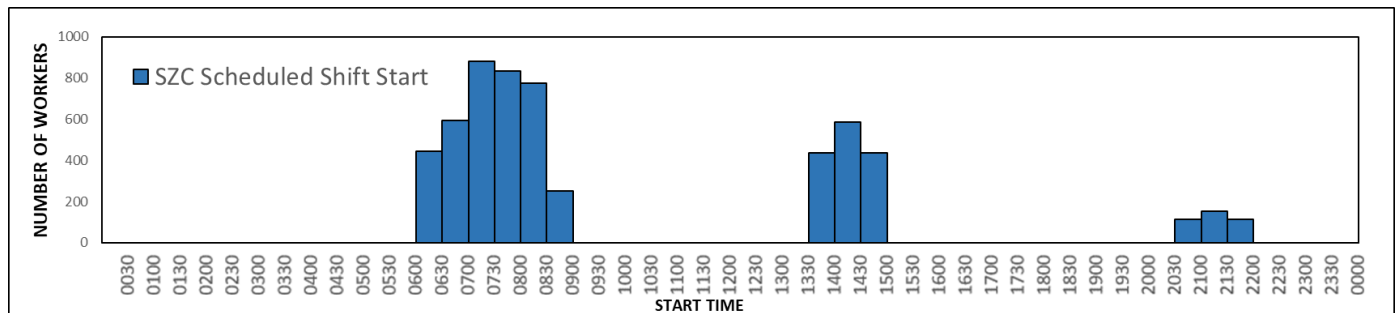

Figure 6 - SZC Shift End Times (Peak Construction)

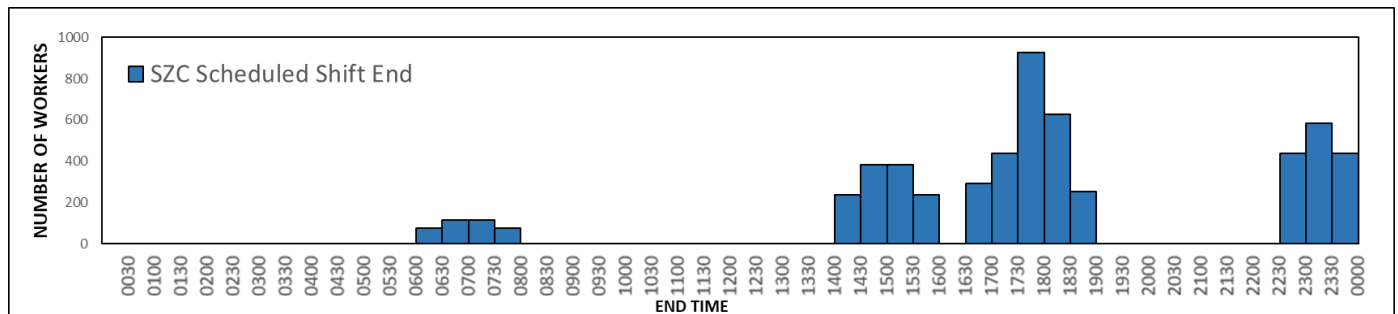
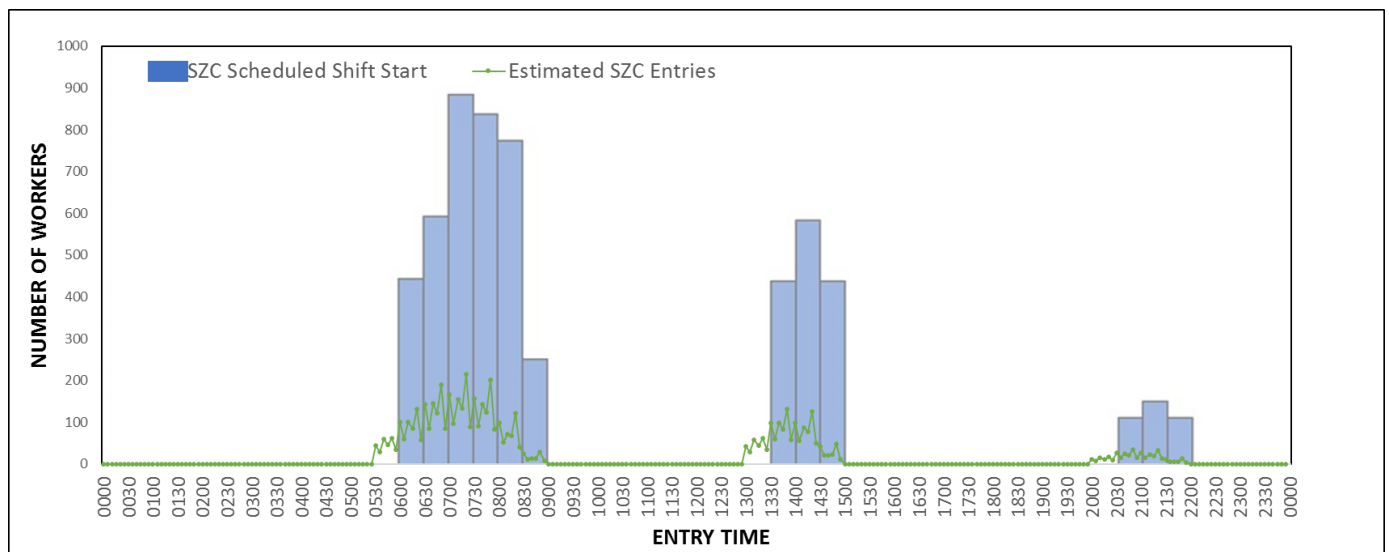

Figure 5 and Figure 6 illustrate the trapezoidal shape that was assumed. Figure 5 shows that there is a total of 12 different half hourly periods per day where a SZC shift is assumed to start, with a peak period from 07:00-07:30. Figure 6 shows that there is a total of 16 different half hourly periods per day where a SZC shift is scheduled to end, with a peak period from 17:30-18:00.

Estimated SZC Entry Profile

For each of the 12 half-hourly periods where a SZC shift is assumed to start (illustrated in Figure 5), the scheduled workers for that shift have been profiled across the preceding hour using the derived 'typical' entry profile (Figure 2). The profile was applied relative to the end of each 30-minute shift start period e.g. for the shift starting at 06:00-06:30, the 'typical' profile was applied to the hour ending 06:30 meaning worker arrival times for this shift are distributed from 05:30-06:30. The resultant SZC worker entry distribution is shown for each 5-minute period alongside the scheduled SZC shift start times in Figure 7 below.

Figure 7 – Estimated SZC Entry Distribution



SZC Exit Profile

Similarly, for each of the 16 periods where a SZC shift is scheduled to end (illustrated in Figure 6), the scheduled workers for that shift have been profiled across the preceding hour and the following half hour using the derived HPC exit profile (Figure 4). As above, the profile was applied relative to the end of each 30-minute window e.g. for the shift ending from 06:00-06:30, the ‘typical’ profiling was applied from 05:30-07:00. The resultant SZC exits for each 5 minute period are illustrated alongside the scheduled SZC shift end times in Figure 8 below.

Figure 8 – HPC Profiled SZC Exits

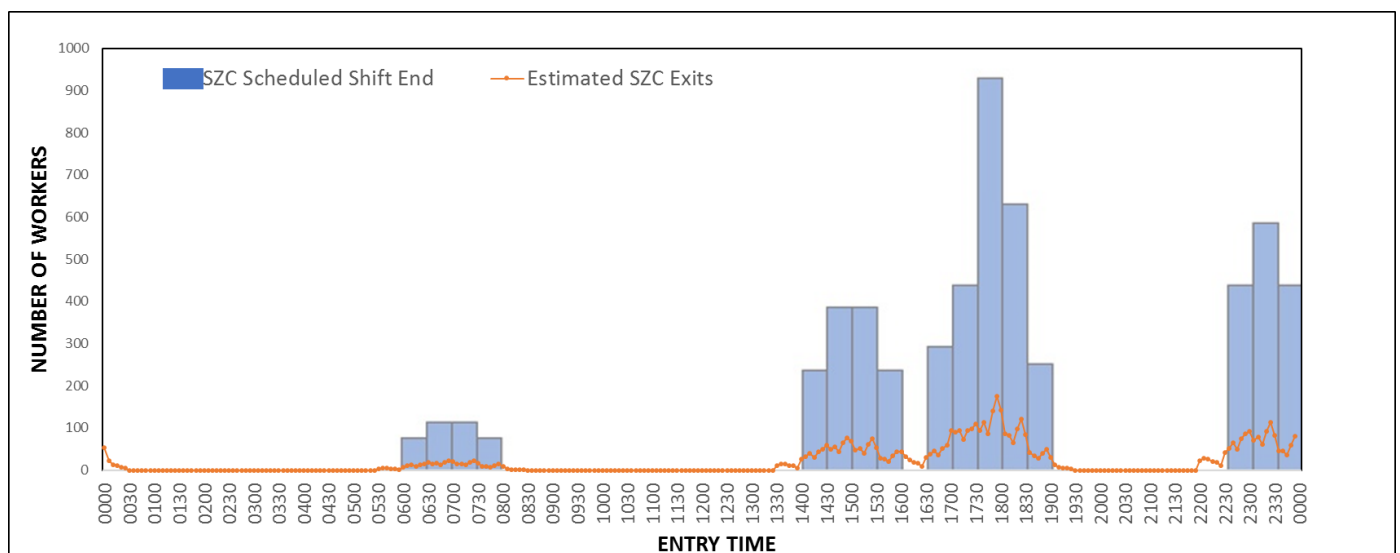

APPLICATION IN VISSIM

Profile Offsets

The SZC entry and exit profiles derived in the previous section show the estimated distribution of arrivals and departures at the SZC construction site. The same profile patterns are likely to be replicated on the surrounding road network albeit slightly offset to account for any travel time. The estimated profiles have therefore been offset ready for use in the two Sizewell C VISSIM models.

The two VISSIM models have been prepared to assess the Yoxford area and the A12 corridor between Seven Hills and Melton. For each VISSIM model, the construction site arrival/departure profiles (Figure 7 and Figure 8) have been offset (backward for entries and forward for exits) by the travel time from the SZC site to Yoxford and the A12 near Martlesham respectively. The offsets were derived using Google Maps' typical journey times, as follows:

- Yoxford: offset by 15-minutes; and
- A12 near Martlesham: offset by 40-minutes

The resultant entry and exit profiles at the SZC site, Yoxford and Martlesham (A12), are shown on Figure 9 and Figure 10 respectively.

Peaks in the entry profile (Figure 9) can be observed to occur earliest at the A12, then at Yoxford 25-minutes later, then at the Sizewell C site 15-minutes after that which is in line with the approximate travel times to the site.

Figure 9 – Estimated SZC Entries on site, at Yoxford and on the A12 near Martlesham

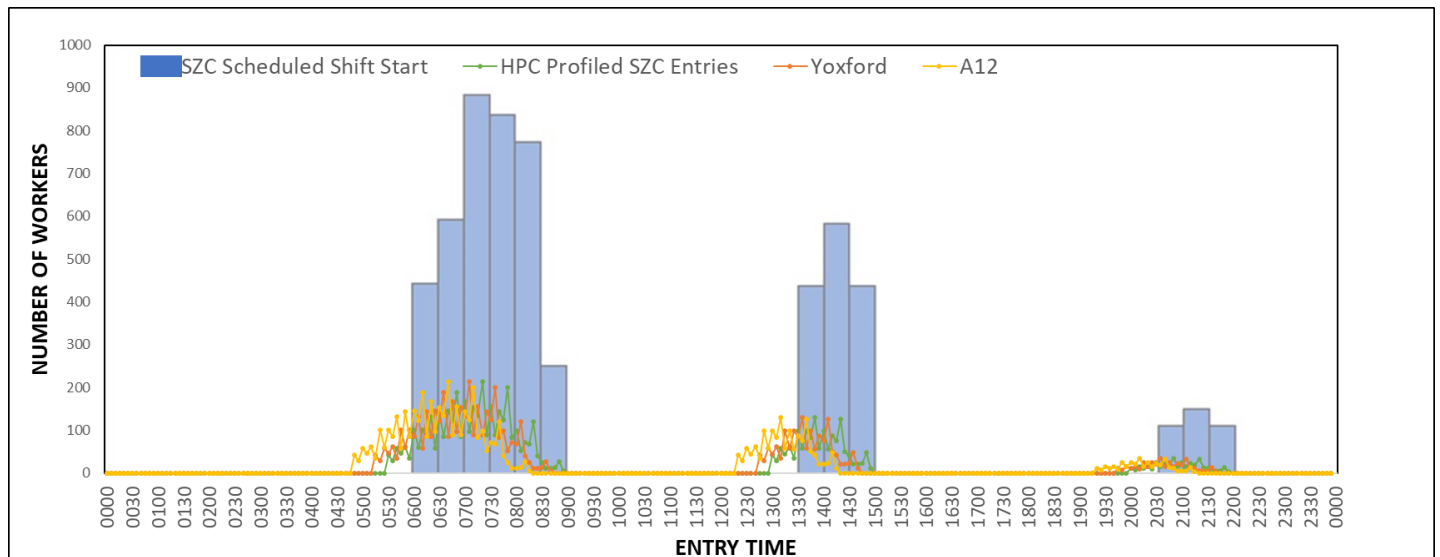

Peaks in the exit profile (Figure 10) can be seen to occur earliest at the Sizewell C site, then at Yoxford 15-minutes later and then at Martlesham (A12) 25 minutes after that in line with the approximate travel times from the site.

Figure 10 - Estimated SZC Exits on site, at Yoxford and on the A12 near Martlesham

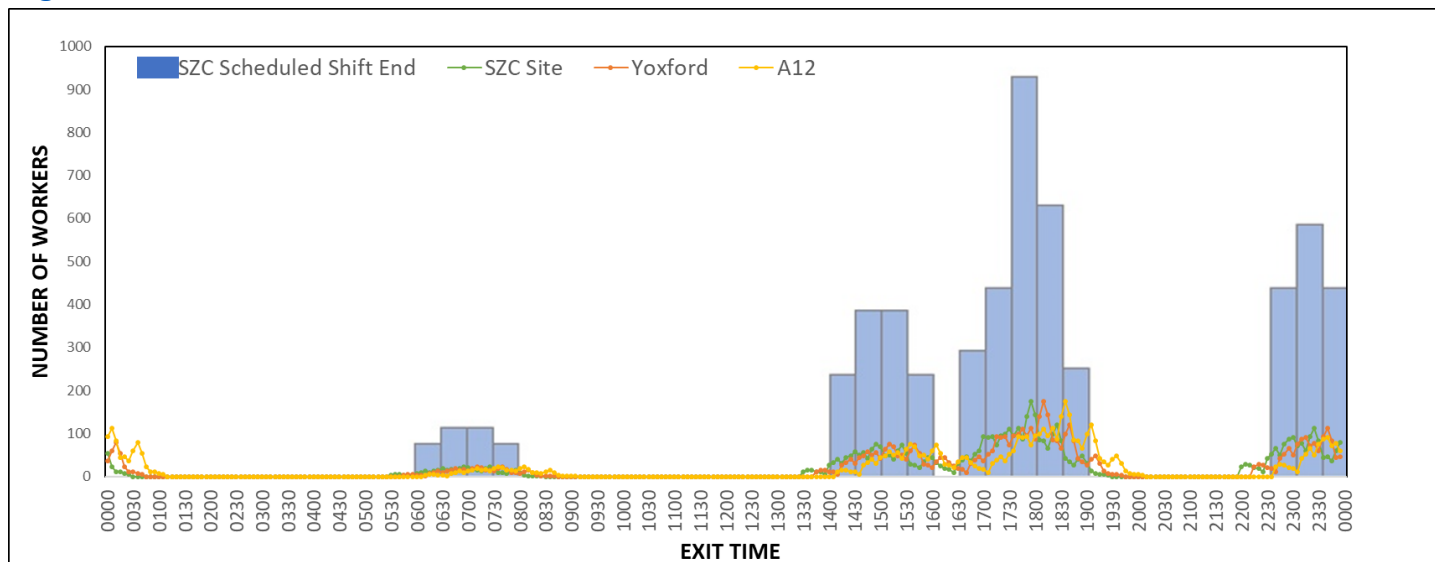

Calculation of 15-minute distribution percentages

Based on Figure 9 and Figure 10, the number of SZC worker trips expected to arrive in each VISSIM study area in each 15-minute period has been expressed as a percentage of the hourly SZC worker trips. In other words, four profiling percentages were calculated for each hour which sum to 100%.

This approach was adopted so that the hourly volumes of SZC workers could be sourced from the VISUM model meaning the VISSIM model remains consistent. It is also important that the SZC worker demands come from VISUM as these volumes account for the change in shift patterns between the Early Years and Peak Construction scenarios. The only difference with the SZC worker demand in VISSIM is the presence of a non-flat profile. Applying the profiling as a set of percentages for each hour allowed the arrival / departure distributions to be applied to the 2023 Early Years and 2028 Peak Construction SZC worker volumes respectively ensuring that the differing peaks in Sizewell C worker volumes in 2023 and 2028 are allowed for.

The VISSIM models cover the following hours and profiling percentages were therefore needed for these seven hours:

- 06:00 - 07:00;
- 07:00 - 08:00;
- 08:00 - 09:00;
- 15:00 - 16:00;
- 16:00 - 17:00;
- 17:00 - 18:00; and
- 18:00 - 19:00 (Yoxford only)

The resultant entry and exit profiles of SZC workers at Yoxford are set out in Table 2. Note that there are no profiles shown for entries from 15:00-19:00 because no SZC arrivals are anticipated during this period, as illustrated in Figure 9 above.

Table 2 – SZC Worker Profiling at Yoxford

Modelled Hour	15-minute Period (minutes past the hour)			
	00:00-00:15	00:15-00:30	00:30-00:45	00:45-01:00
ENTRY PROFILE				
06:00 - 07:00	19%	26%	27%	28%
07:00 - 08:00	30%	27%	28%	15%
08:00 - 09:00	70%	15%	15%	0%
EXIT PROFILE				
06:00 - 07:00	7%	24%	30%	39%
07:00 - 08:00	29%	27%	27%	17%
08:00 - 09:00	62%	30%	8%	0%
15:00 - 16:00	29%	27%	27%	17%
16:00 - 17:00	28%	28%	13%	32%
17:00 - 18:00	15%	28%	26%	32%
18:00 - 19:00	35%	27%	25%	14%

The resultant entry and exit profiles of SZC workers on the A12 near Martlesham are set out in Table 3.

Table 3 – SZC worker profiling at A12 near Martlesham

Modelled Hour	15-minute Period (minutes past the hour)			
	00:00:00:15	00:15-00:30	00:30-00:45	00:45-01:00
ENTRY PROFILE				
06:00 - 07:00	28%	21%	31%	20%
07:00 - 08:00	45%	23%	25%	7%
08:00 - 09:00	89%	11%	0%	0%
EXIT PROFILE				
06:00 - 07:00	6%	22%	21%	51%
07:00 - 08:00	24%	23%	32%	21%
08:00 - 09:00	46%	19%	28%	6%
15:00 - 16:00	23%	23%	32%	21%
16:00 - 17:00	41%	16%	26%	16%
17:00 - 18:00	9%	19%	32%	40%

Application within VISSIM

The entry and exit profiles in Table 2 and Table 3 have been applied to split the hourly SZC worker car trips (from VISUM) into 15-minute matrices that are assigned in the VISSIM model.

It should be noted that the SZC matrices in VISUM also contain a small number of ‘non-work’ trips which are made by ‘non-home based’ workers living either on the accommodation campus or in other rented accommodation, when they are not on shift (i.e. shopping/leisure etc) and trips made by ‘associated development’ workers (e.g. catering, cleaning, admin, security, etc). The construction worker shift pattern profiles are not applicable in these cases, so a flat profile has been assumed for these trips.

Yoxford VISSIM model

Table 4 identifies which profile has been applied to each of the individual movements in the matrices for the Yoxford VISSIM model; the entry, exit or flat profile. SZC trips do not exist for all of the origin-destination pairs listed in Table 4 and the majority of SZC trips head to / from the B1122, A12 South or P&R and therefore receive an ‘entry’ or ‘exit’ profile.

Table 4 – Application of profiles to SZC matrices in the Yoxford VISSIM model

		Destination						
Origin	From \ To	The Street	P&R	A1120	A12 South	A144	A12 North	B1122
	The Street		entry	flat	flat	flat	flat	entry
	P&R	exit		exit	exit	exit	exit	exit
	A1120	flat	entry		entry	flat	flat	entry
	A12 South	flat	entry	exit		exit	exit	entry
	A144	flat	entry	flat	entry		flat	entry
	A12 North	flat	entry	flat	entry	flat		entry
	B1122	exit	entry	exit	exit	exit	exit	

A12 VISSIM model

In the A12 VISSIM model it is assumed that all workers use the A12 to travel to and from the SZC site. Table 5 shows how the three profile types have been applied to different types of SZC trips in the A12 VISSIM model. The majority of the Sizewell C trips travel to/from the A12 North and therefore receive an entry or exit profile rather than a flat profile.

Table 5 – Application of profiles to SZC matrices in the A12 Corridor VISSIM model

Movement	Profile Used
From the A12 North (i.e. southbound)	Exit
To the A12 North (i.e. northbound)	Entry
All other movements	Flat

CONCLUSION

The profiling of workers arriving and leaving the HPC site provides a reasonable approximation of the likely profiling of SZC construction workers relative to their shift start / end times. The HPC entry and exit profiles have therefore been applied to the SZC shift times in order to approximate the distribution of workers relative to their shift times.

Whilst this process provides a high-level approximation of the likely shape of the SZC worker distribution for each hour, the inclusion of any form of peaks in demand will effectively allow the junctions to be stress tested in each hour. The estimated profile will provide a reasonable estimate of when SZC workers travel through both Yoxford and the A12 study areas. This approach is not dissimilar to the approach taken in Junctions 9 where-by a bell-curve profile is assumed so that peaks in demand across the hour are considered. This approach is preferable to assuming a flat profile for SZC trips which would not account for any peaks in demand.



62-64 Hills Road
Cambridge
CB2 1LA

wsp.com